



VOLTA W-H



EN

TECHNICAL MANUAL

MODEL:

SERVICE CONTACT:

Contents

1. General Information	5
1.1. Safety considerations	5
1.2. Disposal	7
2. Heat pump installation	8
2.1. Transport and handling	8
2.2. Dimensions and connections	8
2.3. Unpacking	9
2.4. Assembly and disassembly of the covers	10
2.5. Recommended positioning	11
2.6. Service areas	12
3. Hydraulic installation	13
3.1. General instructions	13
3.2. Brine circuit	13
3.3. Heating / Cooling circuit	14
3.4. DHW circuit	17
3.5. Pool circuit	18
4. Filling and discharge circuits	20
4.1. Filling the production circuit (heating, cooling, DHW and pool)	20
4.2. Filling the brine circuit	20
5. Electrical system	22
5.1. General instructions	22
5.2. Heat pump power supply	26
5.3. External protections	28
5.4. Outside temperature probe	28
5.5. External storage systems	28
5.6. External production equipment	28
5.7. Simultaneous production	29
5.8. DG1 – SG5 Outlet Units	29
5.9. External auxiliary equipment	30
5.10. Alarm signal	30
5.11. Remote services production control	30
5.12. Inside environment control	31
5.13. Remote control by BUS	33
5.14. Energy meter	33
6. Start-up	34
7. Technical specifications	35
7.1. Component location	35
7.2. Powercircuit diagram	38
7.3. Electrical connection tables	39
7.4. Load losses	42
8. Operation map	43
9. Operation curves	44

10. Technical data table..... 47

11. Symbols..... 51

1. General Information



- This manual contains the necessary information to install the heat pump. Read this manual carefully before installing the equipment. Keep this manual handy for future reference.

This manual contains two different kinds of warnings that should be heeded.



NOTE

- Indicates a situation that may cause material damage or malfunctioning of the equipment. May also be used to indicate practices which are recommended or not recommended for the equipment.



DANGER!

- **W**arning of imminent or potential danger which, if not avoided, may result in injury or even death. May also be used to warn of unsafe practices.

VOLTA W-H heat pumps are designed to function within heating systems, cooling systems, for the production of domestic hot water (DHW), pool heating or other similar uses. The manufacturer is not responsible for any material damage and/or personal injury resulting from improper use or incorrect installation of the equipment.

The heat pump must be installed by a licensed installer in accordance with applicable local regulations and in accordance with the installation instructions described in this manual.

1.1. Safety considerations

The detailed instructions in this section cover important aspects for your safety; as such they must be strictly complied with.



DANGER!

- **A**ll the installation and maintenance work described in this manual must be performed by an authorised engineer.
- **C**hildren shall not play with the heat pump.
- **C**leaning and user maintenance shall not be made by children without supervision.
- **I**mproper installation or use of the equipment could cause electrocution, short circuits, leakage of working fluids, fire or other personal injury and/or material damage.
- **I**f you are unsure of the procedures for installation, maintenance or use of the equipment, contact your local dealer or technical support for advice.
- **I**f you detect a malfunction in the unit, contact your local dealer or technical support to answer any questions.
- **W**hen carrying out installation, maintenance or commissioning of the heat pump, always use appropriate personal protective equipment.
- **K**eeP the plastic bags included in the packaging out of the reach of children, as they could result in injury through asphyxia.

Refrigerant

The heat pump uses R410A refrigerant as operating fluid. This refrigerant is not harmful to the environment as it does not contain chlorine, and therefore does not contribute to the destruction of the ozone layer. Under normal operation of the heat pump the toxicity of the refrigerant is nil and there is no risk of explosion. However, the following precautions should be taken in the event of refrigerant leakage.



- The refrigerant contained in the heat pump should not be released in the atmosphere, since it contributes to global warming of the planet (GWP = 2088).
- The refrigerant should be recovered for recycling or elimination according to current legislation.
- Do not directly touch the area where the leak has occurred, as this could result in severe frostbite injuries.
- Ventilate the area immediately.
- Anyone who has come into contact with refrigerant vapour must evacuate the area immediately and breathe fresh air.
- Direct exposure of the refrigerant to a flame produces toxic gas. However, this gas can be detected by its odour when at concentrations well below the permitted limits.

Hydraulic installation

Installation and subsequent interventions on the heating, brine or DHW circuits must only be performed by authorised personnel in accordance with applicable local regulations and the instructions provided in this manual.



- Do not touch any of the internal components during or immediately after heat pump operation; this can result in burns caused by cold or heat. If these components need to be touched, allow sufficient time for the temperatures to stabilise and wear protective gloves to avoid injury.

Water quality

Be aware of how the DHW circuits and tank of the heat pump react to corrosion. If you are not sure about the quality of the water available for filling the system, analyse it. In the following tables you can check the water quality level requirements for the production and brine circuit.

Water components	Concentration in mg/l	Water components	Concentration in mg/l
Alkalinity	$\text{HCO}_3^- < 70$	Free carbon dioxide	$\text{CO}_2 < 5$
Sulphur	$\text{SO}_4^{2-} < 70$	Nitrate	$\text{NO}_3^- < 100$
Alkalinity / Sulphur	$\text{HCO}_3^- / \text{SO}_4^{2-} > 1$	Iron	$\text{Fe} < 0.2$
Ammonium	$\text{NH}_4 < 2$	Aluminium	$\text{Al} < 0.2$
Free chlorine	$\text{Cl}_2 < 1$	Manganese	$\text{Mn} < 0.1$
Hydrogen sulphur	$\text{H}_2\text{S} < 0.05$	Chloride	$\text{Cl}^- < 300$

Table 1.1. Concentration limits of water elements for production and brine circuits.

Water properties	Limit values
pH	7.5 < pH < 9
Hardness	4 < °dH < 8.5
Electrical conductivity	10 < μS/cm < 500

Table 1.2. Water property limits for production and brine circuits.



- **R**isk of damage due to unsuitable water.
- **D**eposits caused by the use of unsuitable water can damage the brine source, the pipes, the heat exchangers and the DHW tank of the heat pump.
- **T**he use of sea water is not permitted.
- **T**he quality of the drinking water must comply with the applicable regional regulations and the instructions in this manual.

Electrical system

Any intervention on the electrical system must only be performed by an authorised electrician in accordance with applicable local regulations and the instructions provided in this manual.



- **R**emember that the heat pump has multiple external power supply.
- **T**he heat pump must be supplied with an external switch that can shut off all the circuits. VOLTA Heat Pumps recommend installing one external automatic breaker in each external power supply (control, internal auxiliary equipment and drive).
- **B**efore performing any operation on the electrical panel, disconnect the power supply.
- **D**uring installation and maintenance of the equipment never leave the electrical panel unattended while it is exposed.
- **D**o not touch any component of the electrical panel with wet hands as this could cause an electric shock.

1.2. Disposal



This device should not be treated as household waste. At the end of its useful life, dispose of the device properly in accordance with local regulations and in an environmentally friendly way.

The heat pump uses R410A refrigerant in its circuit. This refrigerant is not harmful to the environment, but once its useful life cycle has finished, the refrigerant must be recovered and recycled or disposed of according to current regulations.

The heat pump cannot be disposed of with household waste when its useful life ends. Carry out the elimination of the appliance in accordance with the pertinent local regulations, in a correct and respectful way with the environment. Put the product at the end of its useful life in the hands of the waste manager authorized by the local authorities for transport to an appropriate treatment plant.

2. Heat pump installation

2.1. Transport and handling

The heat pump must be transported vertically and not exposed to adverse weather conditions. It can be lain carefully on its rear side to facilitate transportation to the installation site.



NOTE

- Do not tilt the heat pump more than 45°, since this could impair proper equipment operation.
- Due to its heavy weight, the heat pump should be handled by two workers using a forklift for heavy loads.

2.2. Dimensions and connections

The overall dimensions and hydraulic connections of the VOLTA W-H heat pumps are described below.

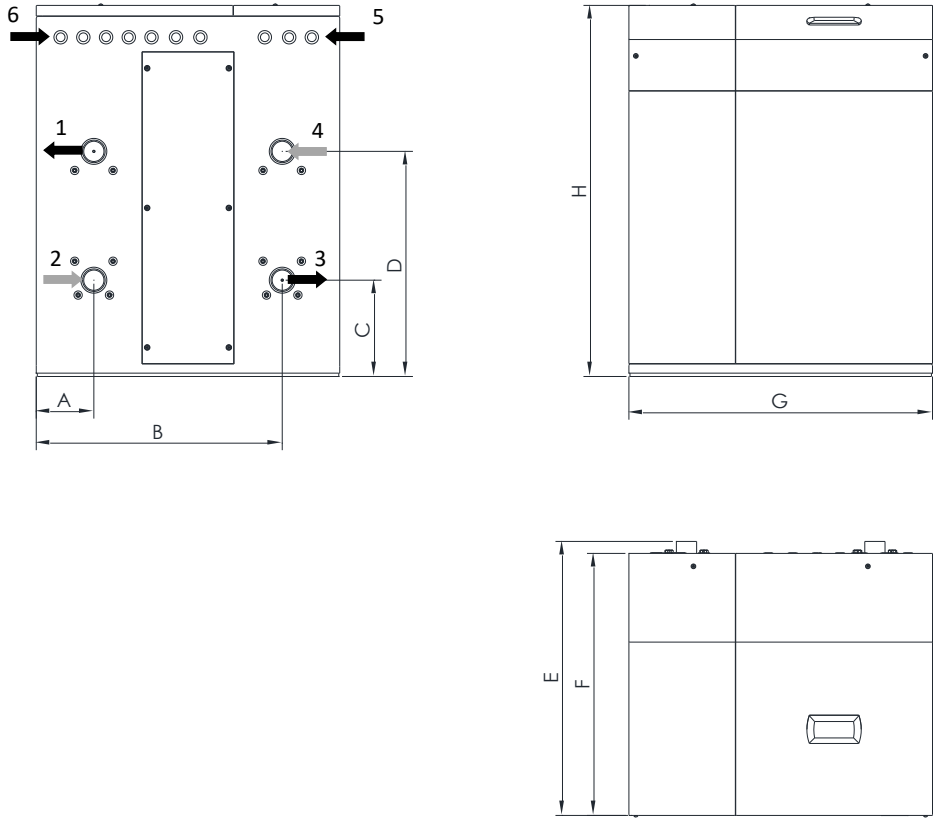

Figure 2.1. Overall dimensions and hydraulic connections of the VOLTA W-H models.

No	VOLTA W-H-H	VOLTA W-H-A	VOLTA W-H-*-40-400	VOLTA W-H-*-60-400	VOLTA W-H-*-90-400
1	Heating supply / heat dissipation	Heating / cooling supply	G2" Male	G2" Male	G2-1/2" Male
2	Heating return / heat dissipation	Heating / cooling return	G2" Male	G2" Male	G2-1/2" Male
3	Brine / cooling supply	Brine supply / heat dissipation	G2" Male	G2" Male	G2-1/2" Male
4	Brine / cooling return	Brine return / heat dissipation	G2" Male	G2" Male	G2-1/2" Male
5	Power cables inlet				
6	Control cables inlet				

Table 2.1. Overall hydraulic connections of the VOLTA W-H.

No.	VOLTA W-H-*-40-400	VOLTA W-H-*-60-400	VOLTA W-H-*-90-400
A	165	165	169
B	705	705	783
C	276	276	276
D	645	645	645
E	785	785	886
F	750	750	850
G	870	870	950
H	1063	1063	1063

Table 2.2. Key to overall dimensions in mm.

2.3. Unpacking

To unpack the heat pump, remove the wooden box carefully, remove the pallet anchoring screws and perform a check to make sure the heat pump has not been damaged during transportation.

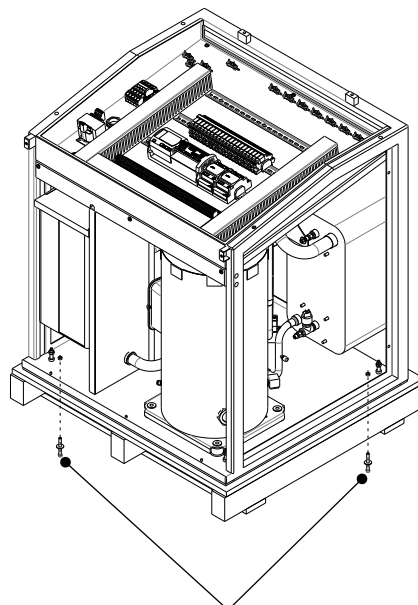

Anchoring studs to the pallet

Figure 2.2. Removing the screws fastening the heat pump to the pallet.

2.4. Assembly and disassembly of the covers

A 4 mm allen wrench is needed to assemble and disassemble the covers.

VOLTA W-H Models

1. Disassemble the top front cover. Remove the front and top screws. Pull the cover upwards.
2. Disassemble the bottom front cover. Remove the screws located at the upper part and pull upwards.
3. Disassemble the side covers. Remove the fastening screws and remove the cover.

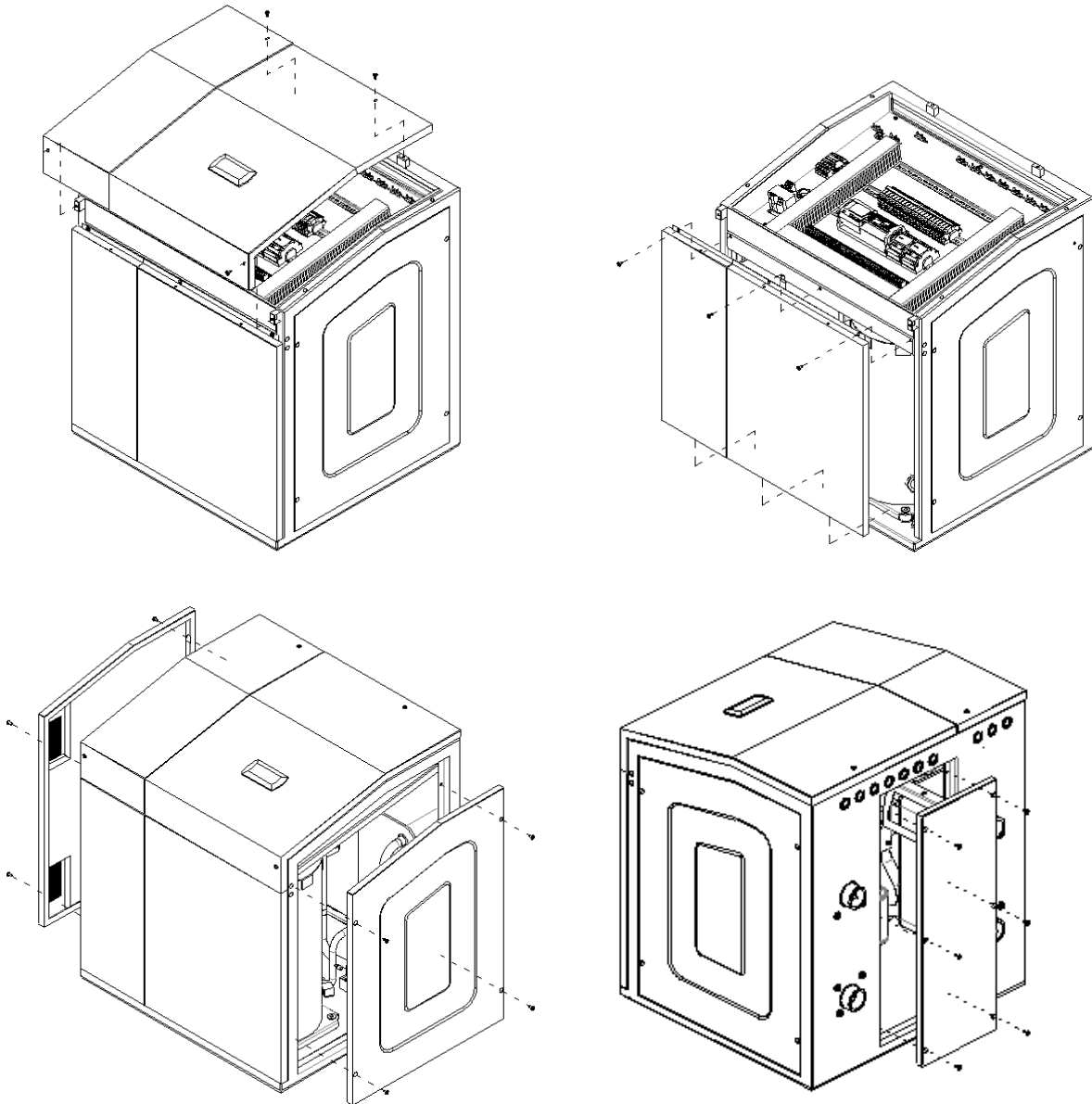

Figure 2.3. Disassembly of the covers of the VOLTA W-H models.



NOTE

- During cover disassembly, take care to remove the control panel cable without damaging it.

2.5. Recommended positioning

Choose a dry place where there is no risk of frost. Avoid installation against bedroom walls or walls of other rooms where noise emissions can be annoying. If possible, install the heat pump with the rear part pointed toward an exterior wall. Avoid installation near a corner, since this can amplify noise emission levels.

The heat pump should be installed on a stable base that can support the total weight of the equipment and the operating fluids in its interior.

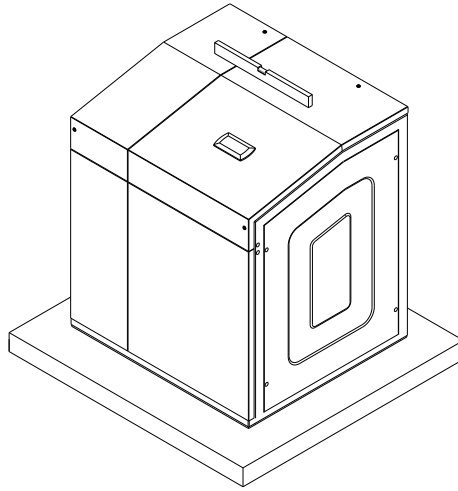

Figure 2.4. Positioning and levelling the heat pump.



NOTA

- Use the eyebolts provided with the heat pump to move the equipment to its final destination.



DANGER!

- **A**dvertising: The VOLTA W-H heat pumps are IP20. This means its installation in high humidity conditions (laundries, saunas, ...) is forbidden.

2.6. Service areas

The minimum recommended distances to be left around the heat pump to facilitate installation, start-up and maintenance work are indicated below.

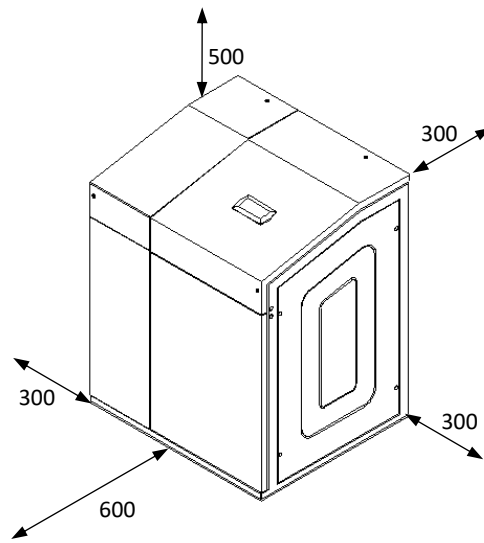

Figure 2.5. Minimum recommended service areas around the heat pump (amounts in mm).

3. Hydraulic installation



NOTE

- The installation schemes included from here on should be considered simply as a guide.
- The design of the hydraulic installation must be performed by qualified personnel and in accordance with applicable local regulations.
- The design of the hydraulic system must ensure at all times the minimum required flow through the heat pump, otherwise, could cause malfunction of the equipment and even rupture.

3.1. General instructions

The following recommendations should be taken into consideration for proper hydraulic installation.

- Avoid excessive strain between the pipes and the heat pump connections to prevent leaks and/or transmission of vibrations. Flexible hoses should be used for heat pump connections.
- Install cut-off valves at all the hydraulic connections to facilitate future maintenance tasks.
- Install traps at all the installation points where air pockets can form.
- Place heat insulation on all circuit pipes to prevent unnecessary heat loss. Pay special attention to the heating insulation on the brine circuit pipes, since these can reach temperatures below 0°C, causing condensation and/or frost.



DANGER!

- During installation work on the hydraulic circuits, take special care to prevent liquid from spilling on the internal electrical heat pump components, which could cause personal injury due to electrocution and/or poor equipment operation.
- Do not install components that might cover the inlet or outlet of the safety valves; this could lead to a risk of some of its components breaking and cause injuries and/or material damage.

3.2. Brine circuit

The VOLTA W-H heat pumps can be used with horizontal or vertical (A) geothermal brine systems or by using groundwater (B).



DANGER!

Carefully check the antifreeze concentration of the working fluid. Do not use automatic fill valves or other items that can change the concentration of the working fluid. Inadequate concentration of the working fluid could cause malfunction of the equipment and even rupture.

Geothermal brine systems

Brine systems with more than one circuit must be connected in parallel, so the flow rate through each one is similar.

Groundwater brine systems

Groundwater brine systems must use a midway exchanger to prevent the heat pump evaporator from corrosion, freezing or getting dirty.

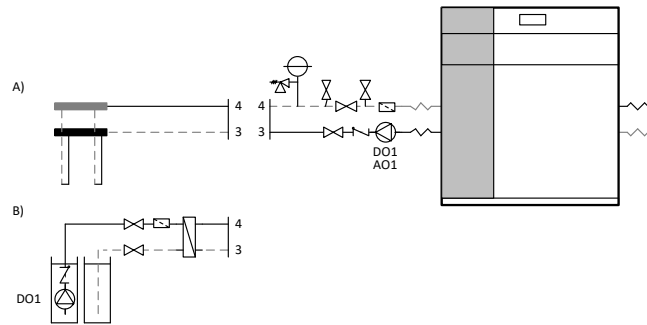

Figure 3.1. Brine circuit connection options.

Installation instructions

Follow the instructions below to wire the brine circuit.

- Install the necessary components to carry out the filling/discharge of the return pipe.
- Install a particulate filter in the return pipe with a mesh size no greater than 1 mm. It is recommended to install shut off valves immediately before and after the filter to make it easier to clean or replace.
- Install a safety unit (expansion vessel + safety valve) in the suction part of the circulator pump to protect the circuit from overpressure.
- Adjust the pressure of the expansion vessel to make sure that the circuit remains pressurised at all points.
- Brine circuit pressure should be between 0,7 and 5 bar (pressure gauge) (70 and 500 kPa).
- Use a working fluid with a freezing point of at least 10°C below the minimum nominal working temperature of the equipment.
- Configure the equipment with a protection of at least 5°C above the freezing temperature of the working fluid.

3.3. Heating / Cooling circuit

The VOLTA W-H heat pumps can be connected to various types of heating / cooling systems, both directly and by separating buffer storage tanks. On the other hand, these enable control over several devices that are external to the heating / cooling system directly from the heat pump's electrical panel.

Heating / cooling system

The VOLTA W-H heat pumps are designed to be used with heating systems with nominal outlet temperatures of up to 55°C; such as underfloor heating systems, low temperature radiators or convectors. They are not recommended for use in heating systems that require higher temperatures.

The VOLTA W-H heat pumps can be used with cooling systems with nominal outlet temperatures of up to 7°C, such as convectors and underfloor cooling systems.

Special care should be taken in the design and control in installations with underfloor cooling, to prevent problems of condensation on floors.

All the models allow control over external passive cooling units.

Direct installation

In simple heating / cooling systems, VOLTA W-H heat pumps can be installed directly into the distribution system, in systems with underfloor heating, low temperature radiators and convectors.

This configuration makes it possible to simplify the hydraulic installation, reduce costs and space, while optimizing the energy efficiency of the equipment. However, the design of the hydraulic installation must guarantee the minimum required flow at all times through the heat pump. For this, the necessary elements must be planned to protect the heat pump in the event of a low flow situation in the emission system. For this, the installation can be planned to operate with at least one of the emission circuits open continuously. If all the emission circuits can be closed, it is recommended to install a differential pressure valve between the outlet

and inlet pipes of the heat pump. Other solutions can also be considered, such as the installation of a hydraulic separator between the heat pump and the emission system, as long as the minimum required flow is guaranteed (see section 10).

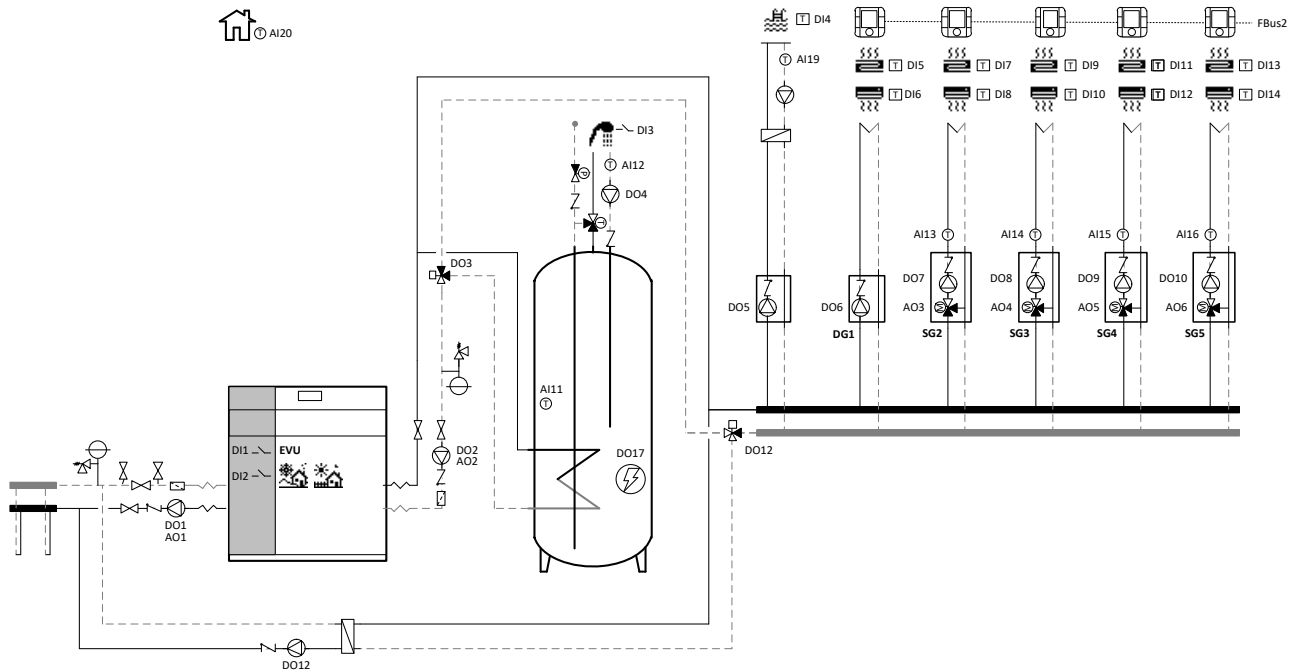

Figure 3.2. Wiring scheme directly to the heating / cooling system (VOLTA W-H-A models).

Installation using buffer storage tanks

If required by the application, the heat pump can also be connected to the heating / cooling system using a buffer separator tank. To do so, it is equipped with two temperature probes that are used to control a buffer storage tank for heating and a buffer storage tank for cooling. In installations where there is only one buffer storage tank for heating and cooling, both probes have to be installed in the storage tank. Install the temperature probes at the points where heating / cooling production begins. Heating / cooling production is stopped by the return temperature probe installed inside the heat pump.

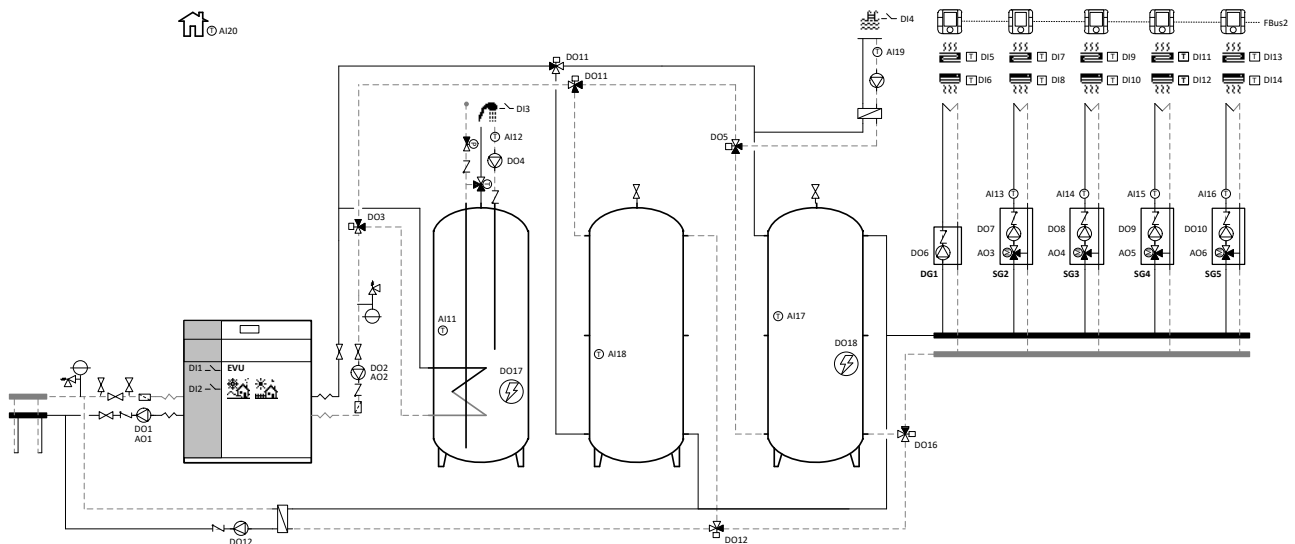

Figure 3.3. Wiring scheme using two buffer storage tanks (VOLTA W-H-A models).

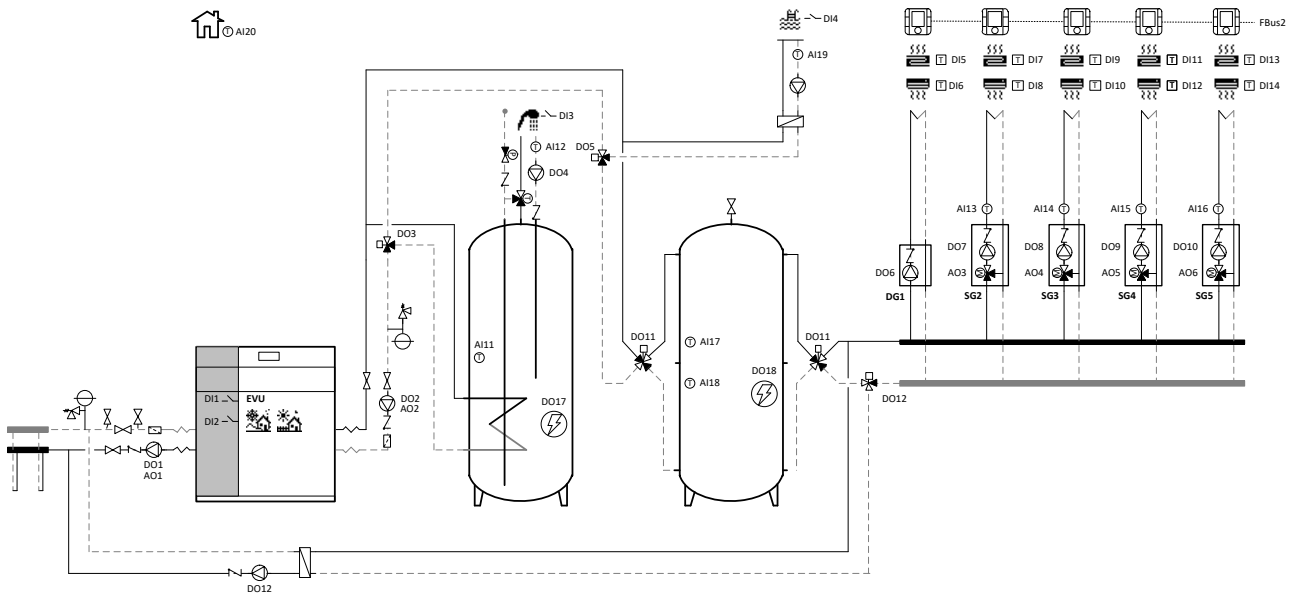

Figure 3.4. Wiring scheme using one buffer storage tanks (VOLTA W-H-A models).

Outlet units

These can manage as many as five different outlet temperatures. This is done by managing one direct outlet unit and four combined outlet units. The combined outlet units have to use modulating 3-way valves with an analogue signal of 0-10Vdc. Each outlet unit has independent terminals for heating and cooling demands. These signals are supplied with 24Vac voltage.

Auxiliary equipment integrated in the heating buffer storage tank

This is used to control an auxiliary unit integrated in the heating buffer storage tank. It can be used for normal heat production or as emergency equipment.

Auxiliary boiler

This is used to control start-up / stop of an auxiliary boiler and regulate final temperature downstream from the boiler by a 0-10 Vdc modulating 3-way valve. The heat pump can use the boiler to assist in normal heat production or as emergency equipment.



NOTE

- The hydraulic installation must ensure that while the boiler is operation, the temperature through the heat pump never exceeds 65°C, since this could cause serious damage to the refrigerant circuit.

Simultaneous production

This is used to control systems that product heat and cold simultaneously. In these types of installations, the heat pump moves energy from the cold production system to the various heat production systems and controls both the hot and cold outlet temperature. On the other hand, it uses modulating valves to detour part of the cold or heat production to the brine system, there by maintaining the energy balance.

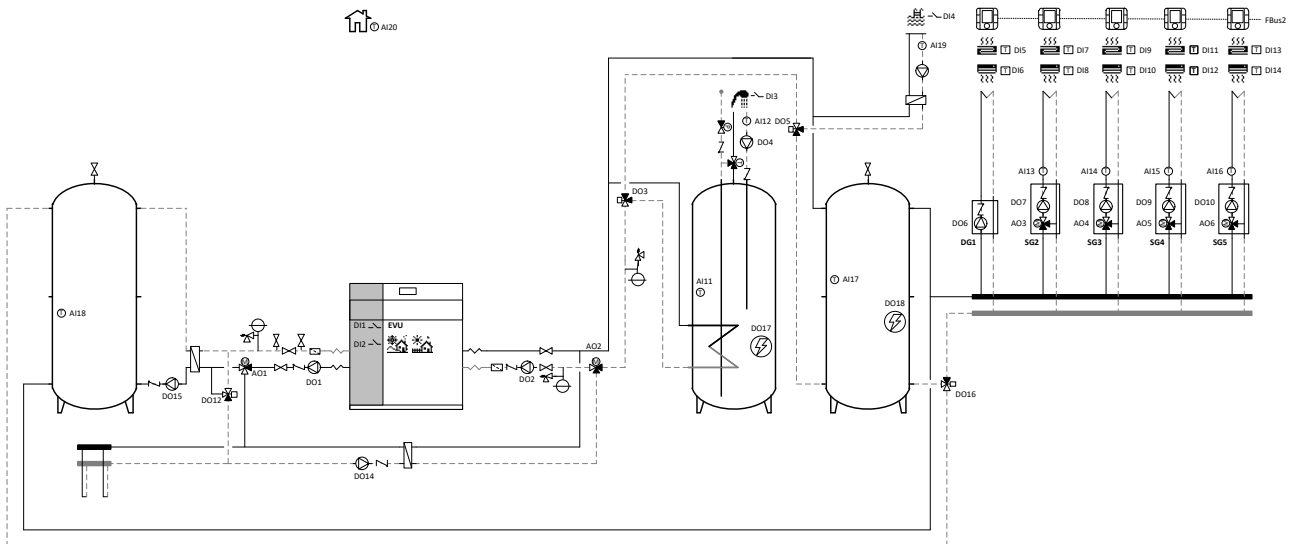

Figure 3.5. Wiring scheme using two buffer storage tanks with simultaneous production (VOLTA W-H-H models).

Installation instructions

Follow the instructions below to connect the heating / cooling circuit.

- Install a particulate filter in the return pipe with a mesh size no greater than 1 mm. It is recommended to install shut off valves immediately before and after the filter to make it easier to clean or replace.
- Check that the volume of the expansion vessel integrated in the heat pump is capable of absorbing any overpressures from the circuit. If this volume is not enough, install a supplementary external expansion vessel.
- If necessary, adjust the pressure of the expansion vessel integrated in the heat pump to guarantee that the circuit remains pressurised at all points.
- If there is an auxiliary system integrated in the heating storage tank, install a safety valve to protect it from any overpressures.
- Heating / cooling circuit pressure should be between 0,7 and 2 bar (pressure gauge) (70 and 200 kPa).

3.4. DHW circuit

The VOLTA W-H heat pumps are designed to be used with external storage systems with a midway heat exchanger that can be either internal or external.

DHW Recirculation

This is used to control a DHW recirculation pump. If an external storage tank without a separate inlet for DHW recirculation is used, it is recommended to connect recirculation to the cold water inlet pipe.

Auxiliary equipment integrated in the DHW storage tank

This is used to control a support system integrated in the DHW storage tank. This can be used as support to reach higher temperatures during normal production, to carry out legionella protection programs or as emergency equipment.

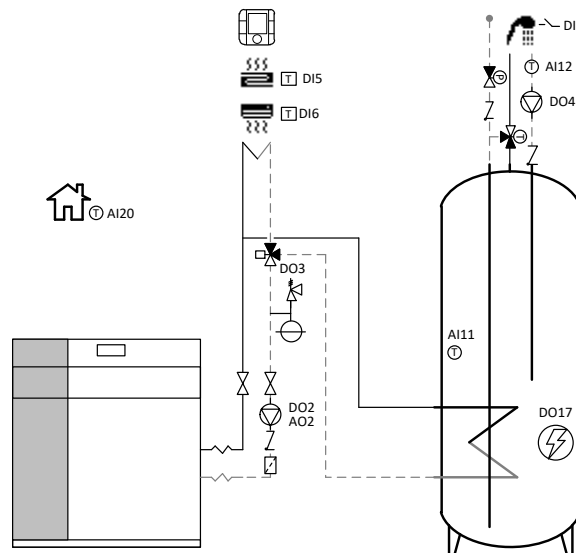

Figure 3.6. Wiring scheme of the DHW circuit

Installation instructions

Follow the instructions below to wire the DHW circuit.

- In the VOLTA W-H models, install a particulate filter in the return pipe to the heat pump with a mesh size no greater than 1 mm. It is recommended to install cut-off valves immediately before and after the filter to make it easier to clean or replace.
- The DHW tank is permanently connected to the tap water supply.
- Install a check valve at the tap water inlet to prevent the possible return of hot water from the mains.
- A safety group (expansion vessel + safety valve) must be installed at the tap water inlet to prevent possible overpressure in the DHW storage tank.
- If there is a risk of scalding, a thermostatic mixing valve should be installed at the DHW outlet.
- If the maximum system pressure can exceed 5 bar, it is recommended to install a pressure reducing valve in the mains inlet to prevent overpressure in the storage tank.
- If there is an auxiliary system integrated in the DHW storage tank, install a safety valve in the production circuit inlet to protect it from any overpressures.

3.5. Pool circuit

The VOLTA W-H heat pumps can be used to send hot water directly to the pool production storage tank through an open / close 3-way valve. The POOL mode must be activated via a voltage-free signal from a thermostat.

Connection to the heating circuit

In models that are not equipped with the HTR system, pool production should be connected to the heating circuit via an open / close 3-way valve. This type of connection allows non-simultaneous production for the pool on the one hand and heating or cooling on the other hand.

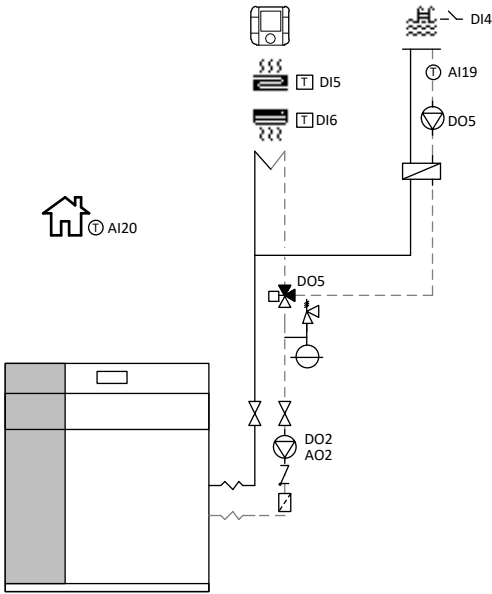

Figure 3.7. Pool production wiring schemes

EN

4. Filling and discharge circuits



DANGER!

- During filling work on the hydraulic circuits, take special care to prevent liquid from spilling on the internal electrical heat pump components, which could cause personal injury due to electrocution and/or poor equipment operation.

4.1. Filling the production circuit (heating, cooling, DHW and pool)

Take the following steps to fill the circuit.

1. Open all the valves of the production circuits.
2. Fill the circuit through the filling valve until the target pressure is reached. Make sure that the pressure does not exceed 3 bar (pressure gauge) under any circumstance.
3. Remove the air from the circuit using the traps installed for that purpose.
4. Check the circuit pressure and repeat the filling process if necessary.

4.2. Filling the brine circuit

The brine system temperature can fall below 0°C, so a mixture of water/antifreeze must be used. It is recommended to use propylene glycol as an antifreeze additive or ethylene glycol with a corrosion inhibitor. Please check local regulations before using any type of antifreeze mixture.

When preparing the mixture, be careful to calculate the volume of antifreeze necessary to reach the desired degree of antifreeze protection. It is recommended to use a mixture with a freezing point at least 10°C below the nominal minimum temperature.

Brine circuit filling should be done with the filling unit installed in the return pipe and an external circulation pump, taking the following steps.

1. Prepare the appropriate proportions of antifreeze mixture in external tank A.
2. Connect the external recirculation pump outlet to valve D.
3. Connect a transparent hose from valve E to antifreeze mixture tank A.
4. Close valve C and open filling valves D and E.
5. Start the external recirculation pump and keep it running until the return is completely free of air and the antifreeze mixture is mixed perfectly.
6. Open valve C and keep the external pump connected to remove the air between valves D and E.
7. Close valve E and pressurise the circuit to target pressure. Make sure that the pressure does not exceed 3 bar (pressure gauge) under any circumstance.
8. Close valve D.

After completing the brine circuit filling process, it is recommended to check the concentration of antifreeze mixture again using a refractometer.

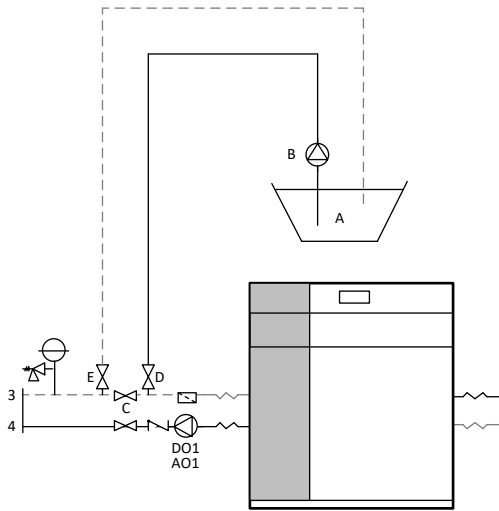

Figure 4.1. Filling the brine circuit.

5. Electrical system



DANGER!

- **B**efore performing any operation on the electrical panel, disconnect the power supply.
- **R**emember that the heat pump has more than one electrical power supply.
- **V**OLTA Heat Pumps recommends that an external switch be installed for each of the electrical power sources (control, internal auxiliary equipment and inverter).
- **A**ny intervention on the electrical system must only be performed by an authorised electrician in accordance with applicable local regulations and the instructions provided in this manual.
- **T**he cables used to connect the heat pump must comply with applicable national regulations.
- **I**nstall cables entering the heat pump in such a way that they have no voltage, cannot become corroded, are not affected by vibration and do not touch sharp edges.
- **I**nstall power cables so that the ground cable is at least 50mm longer than the rest of the cables, to ensure that it is the last cable to be disconnected in case of accidental disconnection.

5.1. General instructions

The locations of the main electrical panel components are shown below.

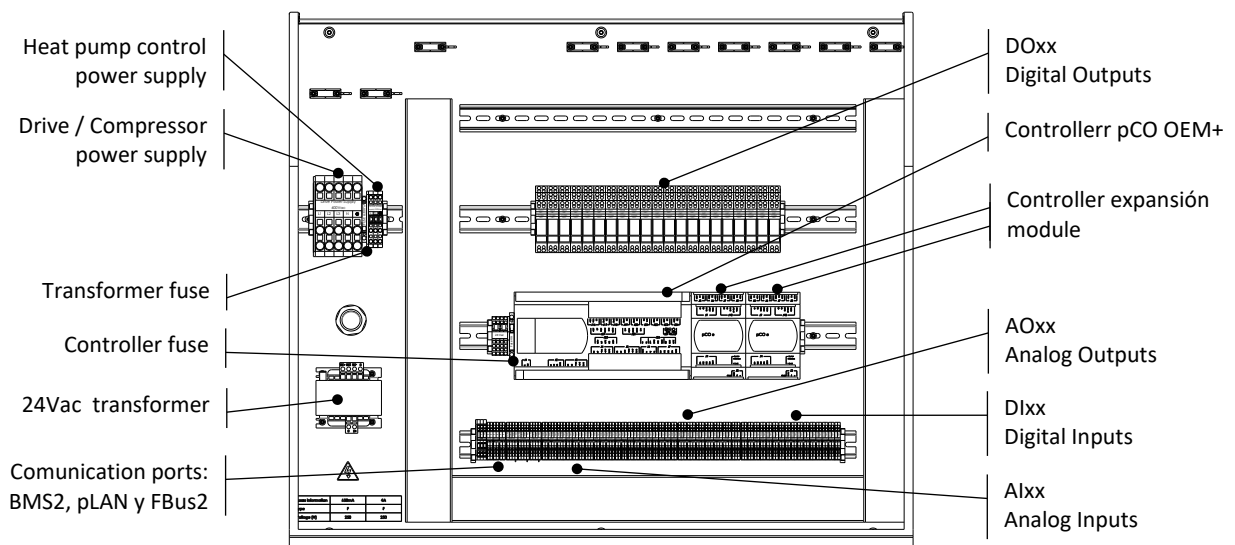

Figure 5.1. Location of the components in the electrical panel.

Several installation devices are controlled from the heat pump electrical panel. Some are internal and other are installed externally. The internal components are connected to the electrical panel in the factory. Depending on the installation that the heat pump is going to be connected to, in addition to the power supply, it may be necessary to connect various temperature probes (analogue inputs AIxx), control signals from thermostats or other external equipment (digital inputs DIxx) on/off switching of pumps and/or valves (digital outputs DOxx) or regulation of pumps and/or valves (analogue outputs AOxx).

The figure below shows a sample installation with the options for connecting external components to the heat pump.

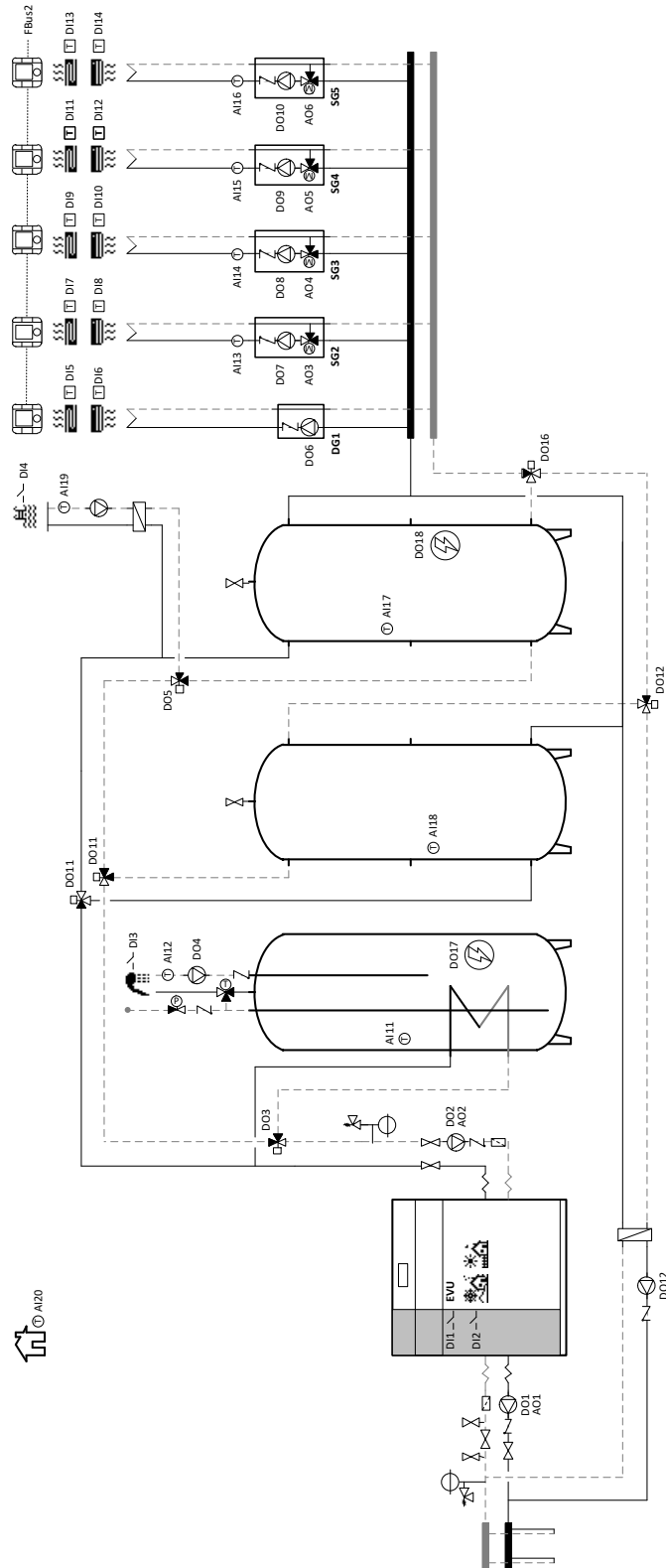

Figure 5.2. General electrical connections scheme of the heat pump.

Analogue inputs (AIxx)

These terminals are used to connect external temperature probes. Only passive NTC temperature probes can be connected, so cable connection polarity is not important.

If necessary, use extension cables with a maximum length of 50 m and a minimum diameter of 0,75 mm². For greater lengths (up to 120 m) it is recommended to use cable with a section of 1.5 mm².

i
NOTE

- Use original temperature probes only; other types of components could cause poor heat pump operation and/or cause heat pump component breakdowns.

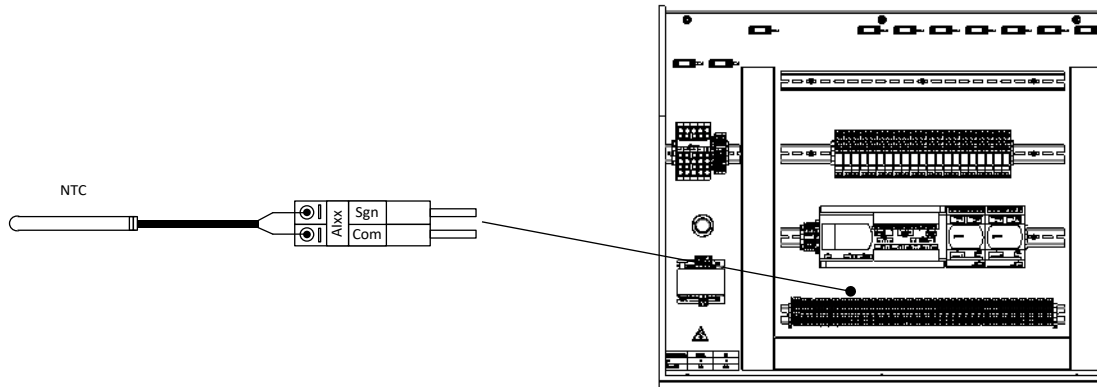

Figure 5.3. Example of temperature probe connections.

Digital control inputs (D1xx)

Digital signals from thermostats or other external devices can be connected to these terminals to control heat pump production functions.

i
NOTE

- Take special care with the working voltage of each digital input; improper handling could cause poor heat pump operation and/or heat pump component breakdowns. Some digital inputs require voltage-free signals, while others require 24Vac signals, 24Vac are powered by the terminal block connection.
- Do not combine free signal with 24Vac signal.

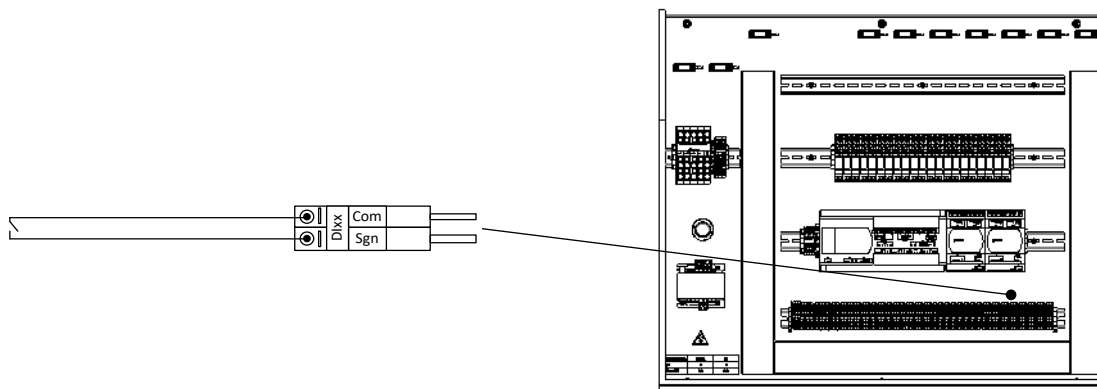

Figure 5.4. Example of voltage-free digital input connections.

i
NOTE

- Heat pump provides 24Vac connection from the electrical panel, all the devices connected to the heat pump cannot exceed 48VA or 2A. Exceed these limits could cause poor heat pump operation and/or heat pump component breakdowns.

EN

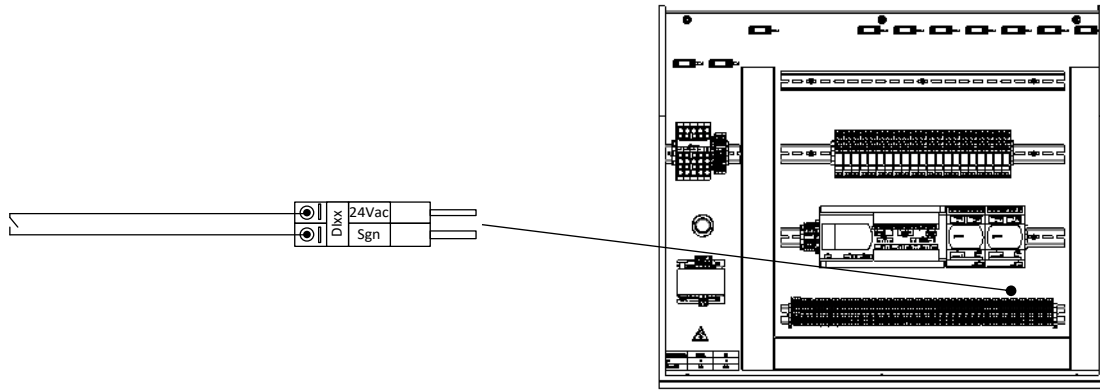

Figure 5.5. Example of digital input connections with 24Vac voltage.

Analogue outputs (AOxx)

These terminals send analogue 0-10Vdc regulation signals to modulate the control of outlet units with mixture, aérothermal brine units with variable speed fan, external auxiliary boilers, etc. On the other hand, these connectors have a 24Vac power supply terminal to supply the modulating valve motor.

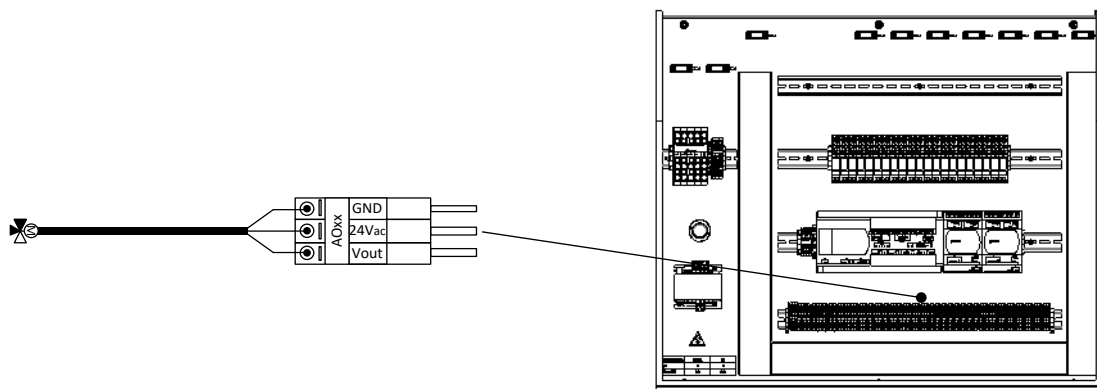

Figure 5.6. Example of 0-10Vdc modulating regulation signal connections.

Digital outputs to relay (DOxx)

The relay terminal block provides digital outputs to control external equipment, such as circulator pumps or open / closed valves. Each relay should be powered externally with the operating voltage of the component to be controlled. Power is supplied to each relay separately, so different operating voltages can be used in each. The following figure shows an example of an installation of a relay power supply.

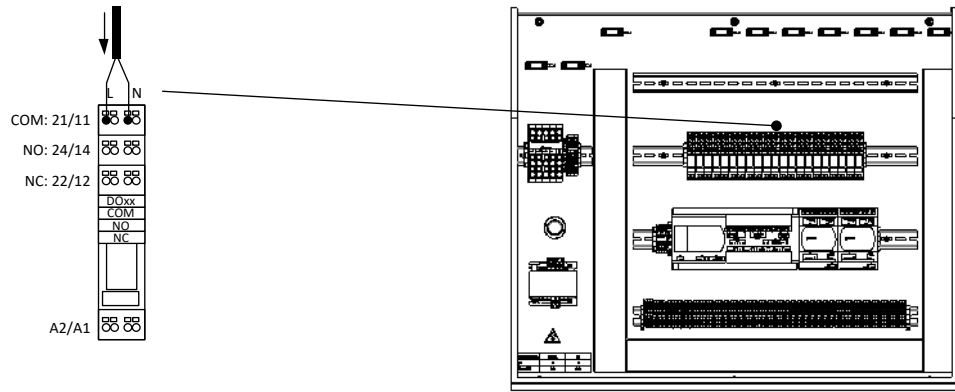

Figure 5.7. Example of digital output relay power supply connections.

Each relay allows independent pole switching; it can thus control the switching on/off of the units, including those powered with a different voltage. The capacity of the relays is 8A/250Vac per pole. If the equipment to be controlled exceeds this capacity, an external relay or contactor must be installed. Shown below are examples of connections between circulator pumps and 3-way valves with controls at 2 or 3 points.



NOTA

- Pay special attention to the maximum consumption allowed by each relay. Use an intermediate relay for the connection, if necessary.

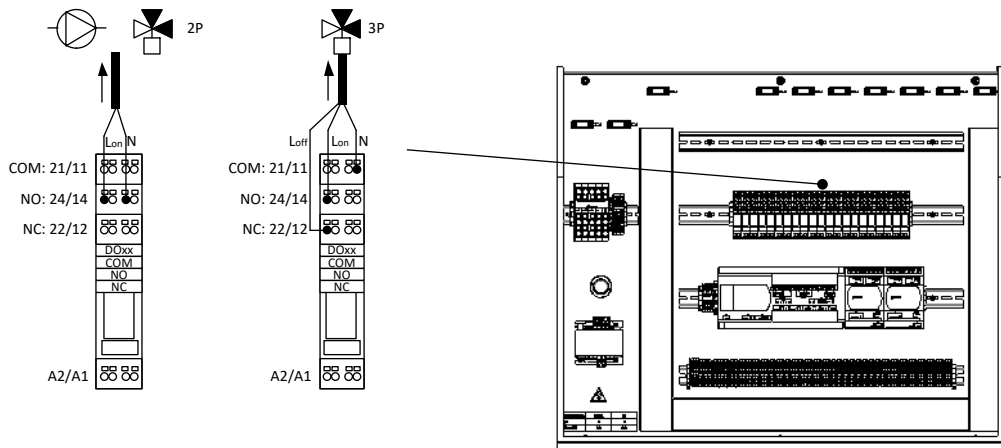

Figure 5.8. Example of digital output connections.

ModBus RS485 (FBus2) Communication Port

Internal terminals with tHT bus communication data can be connected to this terminal.

5.2. Heat pump power supply

VOLTA Heat Pumps VOLTA W-H heat pumps require two power supply points. One for the power supply of the control panel; this unit includes the power supply of the internal and external valves and also that of the regulation signals and the digital and analogue inputs. The other power supply is exclusively dedicated to the compressor. Heat pumps must be powered via an automatic external differential switch which switches off all the circuits and which detects at least alternating or pulsating leakage currents with or without a continuous component, i.e. a type A or A HI component (). In addition to the differential switch mentioned above, the heat pump must be protected by an external thermal-magnetic switch.

To carry out the electrical installation, insert the power cables through the cable grommet holes at the back of the heat pump. Continue by connecting the cables to the power terminal block of the heat pump, as described in figures 5.9 and 5.10.

Power supply of the control panel

The control panel power supply is always single-phase; the following table shows the characteristics of the necessary electrical connection:

Model	Type of power supply	Type of protection	Cut-off current	Recommended cable section
VOLTA W-H-*-40-400	1/N/PE 230 V / 50-60 Hz	Magnetic, thermal and differential protection	1 A	1 mm ²
VOLTA W-H-*-60-400				
VOLTA W-H-*-90-400				

Table 5.1. Characteristics of the control panel's power supply.

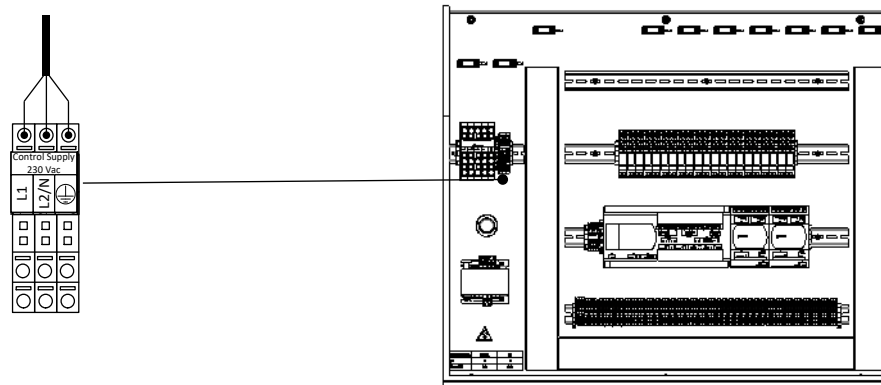

Figure 5.9. Connection scheme of the control panel's power supply.

Power supply of the compressor

The compressor power supply is always three-phase. The following table shows the characteristics of the necessary electrical connection.

Model	Type of power supply	Type of protection	Cut-off current	Recommended cable section
VOLTA W-H-*-40-400	3/PE 400V / 50-60Hz	Magnetic, thermal and differential protection	25 A	6 mm ²
VOLTA W-H-*-60-400			32 A	10 mm ²
VOLTA W-H-*-90-400			50 A	16 mm ²

Table 5.2. Characteristics of the electrical power supply of the compressor.

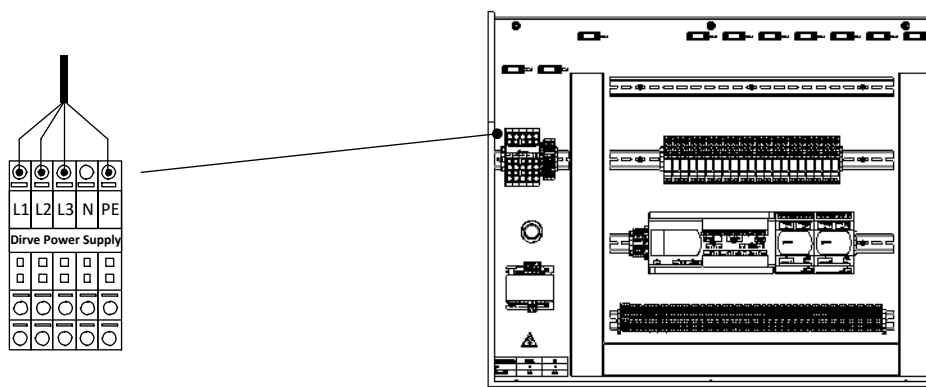

Figure 5.10. Connection scheme of the power supply of the compressor.

5.3. External protections

It is equipped with a connector that can be connected to various types of external mechanical protections, such as flow switches, pressure switches, thermostats, etc.

The ESS connector is used to connect these protections. The external protection devices are powered from the heat pump connector.

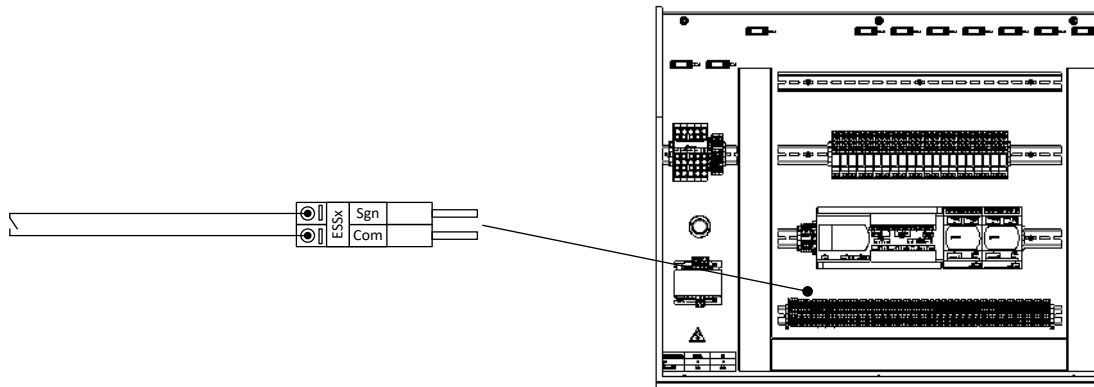

Figure 5.11. Connection scheme of the external protection devices.

5.4. Outside temperature probe

The outside temperature probe, supplied with the heat pump, has to be installed for the heat pump to work properly. Follow the instructions below to install it.

- Install the outside probe in a well ventilated area, but protected from wind and rain.
- Do not install the outside probe at a distance of less than 1 m from windows or doors to avoid the effect of possible currents of warm air.
- Use a shielded 2-pole cable to prevent interferences.

Description	Signal	Type	Connector
Outside temperature probe	Analogue input	NTC 10K 25°C Probe	AI20

Table 5.3. Outside temperature probe connection terminal.

5.5. External storage systems

These can be used to control DHW storage, heating and cooling temperatures using temperature probes.

Description	Signal	Type	Connector
DHW inter-accumulator	Analogue input	NTC 10K 25°C Probe	AI11
Heating buffer storage tank	Analogue input	NTC 10K 25°C Probe	AI17
Cooling buffer storage tank	Analogue input	NTC 10K 25°C Probe	AI18

Table 5.4. Connection terminals for outlet units.

5.6. External production equipment

These are used to control production equipment handling of the various services, such as bypass valves or circulatory pumps.

Description	Signal	Type	Connector
Source pump	Digital output	Activation 230Vac / 8A maximum	DO1
	Analogue output	Valve regulation 0 – 10Vdc	AO1
Production pump	Digital output	Activation 230Vac / 8A maximum	DO2
	Analogue output	Valve regulation 0 – 10Vdc	AO2
DHW production	Digital output	Activation 230Vac / 8A maximum	DO3
DHW Recirculation	Analogue input	NTC 10K 25°C Probe	AI12
	Digital output	Activation 230Vac / 8A maximum	DO4
Pool production	Analogue input	NTC 10K 25°C Probe	AI19
	Digital output	Activation 230Vac / 8A maximum	DO5
Active cooling production	Digital output	Activation 230Vac / 8A maximum	DO11
Passive cooling production	Digital output	Activation 230Vac / 8A maximum	DO12
Auxiliary brine pump	Digital output	Activation 230Vac / 8A maximum	DO14
Auxiliary cooling pump	Digital output	Activation 230Vac / 8A maximum	DO15
Heating / cooling consumption	Digital output	Activation 230Vac / 8A maximum	DO16

Table 5.5. Auxiliary equipment connection terminals.

5.7. Simultaneous production

In installations with simultaneous production, the 0-10Vdc regulation signals of the cooling and heating circuit circulator pumps are used to control the modulating 3-way valves that bypass to the support collector. As a result, only the digital activation signal is used for the circulator pumps.

Description	Signal	Type	Connector
Cooling pump	Digital output	Activation 230Vac / 2A maximum	DO1
Heating pump	Digital output	Activation 230Vac / 2A maximum	DO2
Cooling valve	Analogue output	Regulation 0 – 10Vdc	AO1
Heating valve	Analogue output	Regulation 0 – 10Vdc	AO2

Table 5.6. Connection terminals for installations with simultaneous production.

5.8. DG1 – SG5 Outlet Units

The heat pump can control a direct outlet unit (DG1) and three outlet units with mixture (SG2, SG3, SG4 and SG5). Unit activation can be controlled according to heating or cooling demand. In addition, the units with mixture can measure the unit's outlet temperature and generate a regulation signal for the 3-way modulating valve.

Description	Signal	Type	Connector
DG1 direct unit	Digital output	Activation 230Vac / 2A maximum	DO6
SG2 unit with mixture	Analogue input	NTC 10K 25°C Probe	AI13
	Analogue output	Valve regulation 0 – 10Vdc	AO3
	Digital output	Activation 230Vac / 2A maximum	DO7
SG3 unit with mixture	Analogue input	NTC 10K 25°C Probe	AI14
	Analogue output	Valve regulation 0 – 10Vdc	AO4
	Digital output	Activation 230Vac / 2A maximum	DO8
SG4 unit with mixture	Analogue input	NTC 10K 25°C Probe	AI15
	Analogue output	Valve regulation 0 – 10Vdc	AO5
	Digital output	Activation 230Vac / 2A maximum	DO9
SG5 unit with mixture	Analogue input	NTC 10K 25°C Probe	AI16
	Analogue output	Valve regulation 0 – 10Vdc	AO6
	Digital output	Activation 230Vac / 2A maximum	DO10

Table 5.7. Connection terminals for outlet units.

NOTE

- Heat pump provides 24Vac connection from the electrical panel, remember that all the devices connected to the heat pump cannot exceed 48VA or 2A. Exceed these limits could cause poor heat pump operation and/or heat pump component breakdowns.

5.9. External auxiliary equipment

This is used to control the activation of the auxiliary equipment integrated in the DHW heating buffer storage tanks via outputs to relays. They are also used to control activation of the all / nothing external auxiliary boiler. If modulating boilers are installed, it is also used to control the temperature downstream from the boiler, so the heat pump and the boiler can function simultaneously.

The connection terminals of the SG5 outlet unit are used to manage the auxiliary boilers, so this one cannot be used.

Description	Signal	Type	Connector
Auxiliary heating buffer storage tank equipment	Digital output	Activation 230Vac / 8A maximum	DO18
DHW inter-storage tank auxiliary equipment	Digital output	Activation 230Vac / 8A maximum	DO17
Auxiliary boiler	Analogue input	NTC 10K 25°C Probe	AI16
	Analogue output	Valve regulation 0 – 10Vdc	AO6
	Digital output	Activation 230Vac / 8A maximum	DO10

Table 5.8. Auxiliary equipment connection terminals.

5.10. Alarm signal

If the heat pump cannot start up the compressor because of an active alarm, the heat pump will generate an alarm signal.

Description	Signal	Type	Connector
Alarm signal	Relay digital output	Activation 230Vac / 8A maximum	DO13

Table 5.9. Alarm signal connection terminal.

5.11. Remote services production control

The heat pump is equipped with digital inputs for remote control of production services.

Description	Signal	Type	Connector
Control of electrical consumption (EVU)	Digital input	Voltage-free (0V)	DI1
WINTER / SUMMER program selection	Digital input	Voltage-free (0V)	DI2
Enable / disable DHW production	Digital input	Voltage-free (0V)	DI3
Pool production	Digital input	Voltage-free (0V)	DI4
1 SG signal	Digital input	24Vdc / 24Vac signal	DI15
2 SG signal	Digital input	24Vdc / 24Vac signal	DI16

Table 5.10. Connection terminals for digital inputs that control service production.

Heat pump start-up control (EVU signal)

Enables / disables energy production with both the compressor and the auxiliary equipment. In any event, circulator pumps, valves and other components can be activated to consume energy from the storage systems.

Remote WINTER / SUMMER program selection

Used for remote selection of the heat pump operation program.

DHW production

Enables / disables the DHW production function. If the function is enabled, DHW production is governed by the DHW configuration in the heat pump controller.

Pool production

Activates / deactivates pool production demand. If the signal is requested, pool production is governed by the pool configuration in the heat pump controller.

SMART GRID

Enables / disables the SG states of the heat pump. Depending on the value of the digital inputs, there are four SG operating statuses:

SG1 [0 0] (Normal state): The heat pump is operating normally, as per its configuration.

SG2 [0 1] (Reduced tariff): As we are in a reduced tariff period, we will take advantage of the lower price of electricity to use the pump to produce heat or cold.

SG3 [1 0] (Block status): Signal for compressor blocking to the heat pump.

SG4 [1 1] (Forced state): The heat pump will force the maximum possible consumption in the installation to help balance the network.

These external signals can be sent by the electricity company itself to endeavor to keep the distribution network balanced at all times.

5.12. Inside environment control

The heating and cooling functions can be controlled by digital signals from relay thermostats, by interior terminals with thT bus communication, by a combination of both or not using any interior control terminal.

Relay thermostats

Each outlet unit, from DG1 to SG5, has two 24Vac or 24Vdc digital signals to activate heating or cooling requests from the interior thermostats or other external control devices.

Description	Signal	Type	Connector
DG1 direct unit heating request	Digital input	24Vdc / 24Vac signal	DI5
DG1 direct unit cooling request	Digital input	24Vdc / 24Vac signal	DI6
SG2 mix unit heating request	Digital input	24Vdc / 24Vac signal	DI7
SG2 mix unit cooling request	Digital input	24Vdc / 24Vac signal	DI8
SG3 mix unit heating request	Digital input	24Vdc / 24Vac signal	DI9
SG3 mix unit cooling request	Digital input	24Vdc / 24Vac signal	DI10
SG4 mix unit heating request	Digital input	24Vdc / 24Vac signal	DI11
SG4 mix unit cooling request	Digital input	24Vdc / 24Vac signal	DI12
SG5 mix unit heating request	Digital input	24Vdc / 24Vac signal	DI13
SG5 mix unit cooling request	Digital input	24Vdc / 24Vac signal	DI14

Table 5.11. Connection terminals for digital inputs that control outlet units DG1 - SG4.

A single thermostat or several thermostats connected in parallel can be used for each outlet unit, as shown below.

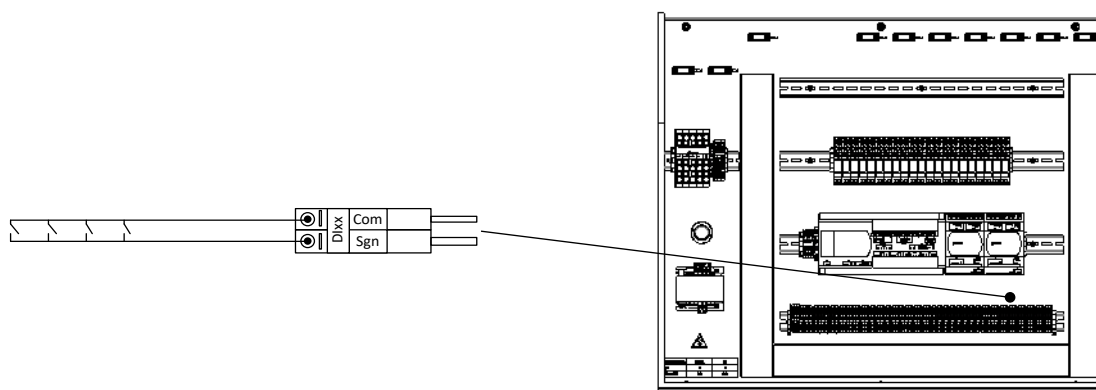

Figure 5.12. Example of connection of several thermostats in parallel.

thT bus terminals

In addition to digital input control (interior thermostats) interior terminals with thT data bus communication can also be used. These terminals capture the inside temperature and humidity of the area associated with each outlet unit, DG1 – SG5, using a serial cable over a Modbus protocol. They also have a digital output to control a valve for the area. A single thT terminal can be connected per outlet unit.

Read the assembly instructions carefully before installing the terminals.

Description	Signal	Connector
thT terminal communication bus	ModBus RS485	FBus2

Table 5.12. Data bus connection terminals for the thT terminals.

Follow the recommendations below to connect the thT terminals to the heat pump.

- Use a three-pole, shielded AWG 20-22 cable for the connection.
- Connect the terminals in series for installations with more than one terminal in the network. The maximum length of the circuit assembly should not exceed 500 metres. For connection networks with more than two thTs, it is necessary to install a 120 Ohm heater between Rx+/Tx+ and Rx-/Tx- in the first and last terminal to prevent possible communication problems.
- Configure the terminal address according to the settings of the controller following the steps described in the thT terminal manual.

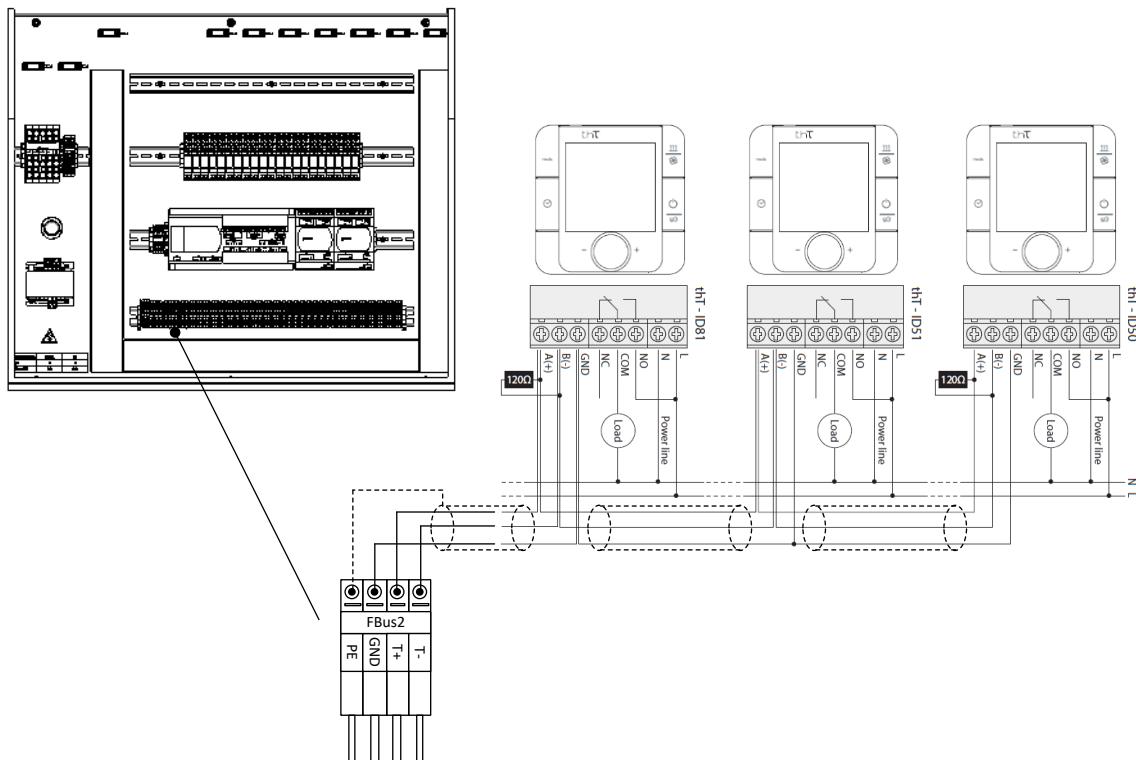

Figure 5.13. Example of connection of thT terminals.

Installation without interior terminals

The VOLTA W-H heat pumps can also be used in installations that do not have any type of interior terminal to generate request signals. In these cases, a continuous request can be imposed at the digital input of the unit to activate by selecting the appropriate control logic in the controller. As a result, the heat pump will run the start / stop cycles according to the temperature control of the circuit and the outside cut-off temperatures of each service.

5.13. Remote control by BUS

The heat pump allows MODBUS communication. Signals can be sent to switch the heat pump on and off, activate the demand for DHW, pool or heating or cooling services for each configured outlet unit and vary the setpoints for DHW, pool and for both heating and cooling in each unit.

Description	Signal	Connector
MODBUS read and write	ModBus RS485	BMS2

Table 5.13. Read and write data bus connection terminals.

Follow the recommendations below for connecting the converters.

- Use a three-pole, shielded AWG 20-22 cable for the connection.
- For installations with more than one heat pump, connect the terminals in series. The maximum length of the circuit assembly should not exceed 500 metres.
- Configure the BMS2 terminal address on the controller following the steps laid out in the technical service manual.

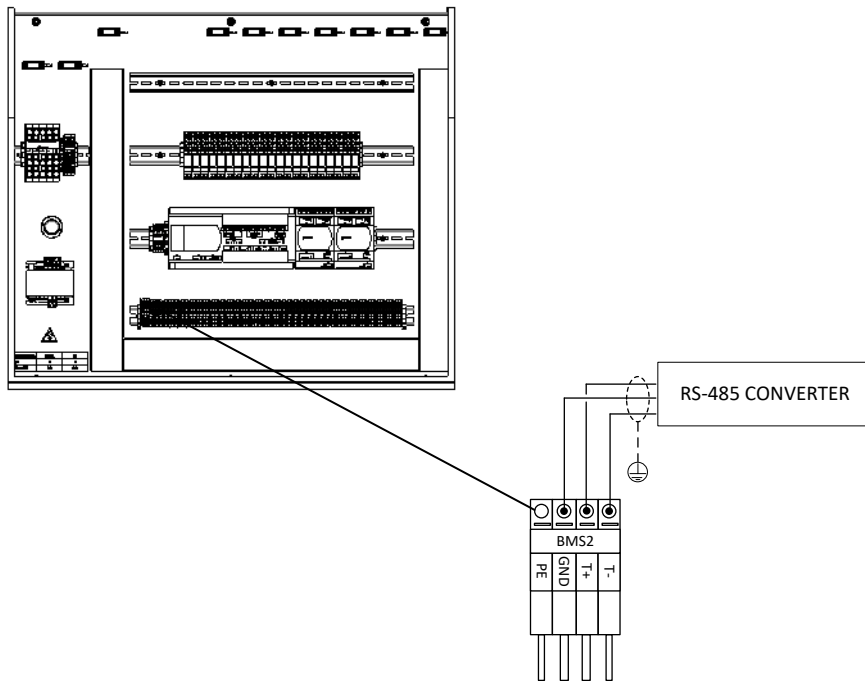

Figure 5.14. Example shown: an RS-485 converter connection for read write data on the heat pump.



NOTE

- For more information about BUS connections, please contact your distributor.

5.14. Energy meter

The heat pump allows MODBUS communication with energy meters supplied by VOLTA Heat Pumps. Before installing the energy meter, carefully read its assembly instructions.

Description	Signal	Connector
Energy meter BUS communication	ModBus RS485	FBus2

Table 5.14. Data bus connection terminals for the energy meter.

Follow the recommendations below to connect the energy meter to the heat pump.

- Use a three-pole, shielded AWG 20-22 cable for the connection.
- Connect the terminals in series for installations with more than one terminal in the network. The maximum length of the circuit assembly should not exceed 500 metres. For connection networks with more than two thTs, it is necessary to install a 120 Ohm heater between Rx+/Tx+ and Rx-/Tx- in the first and last terminal to prevent possible communication problems.
- To install the device supplied by VOLTA Heat Pumps, follow the steps in the manufacturer's installation manual included with the equipment. It is necessary to configure a 100 address on the measurement device for proper communication with your heat pump (See control applications manual).

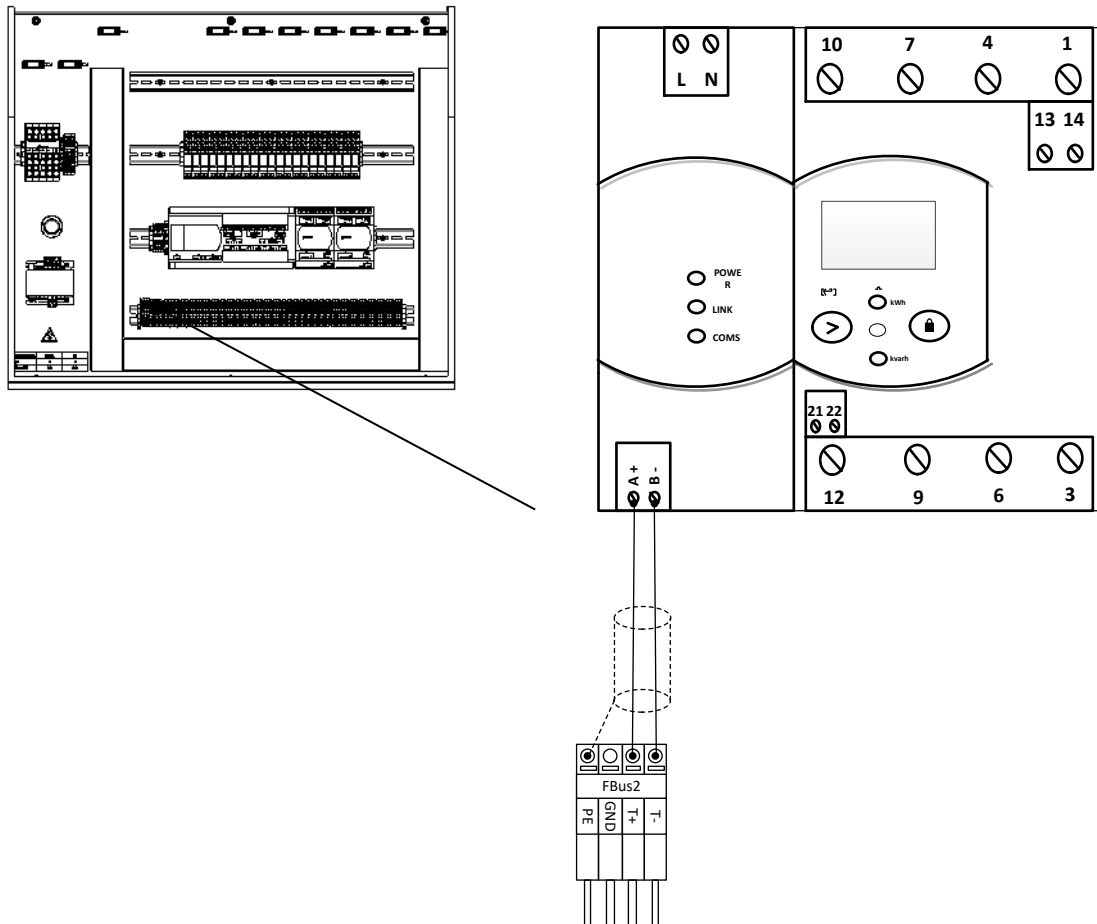

Figure 5.15. Example of connection of energy meter.

6. Start-up

Check the following items before starting up the heat pump. Not doing so could result in poor heat pump operation and/or serious heat pump damage.

1. All the hydraulic circuits of the installation have been properly filled and bled.
2. The cut-off valves of the hydraulic brine and production circuits are open.
3. An external switch has been installed to cut off all the power supply circuits of the heat pump.
4. The heat pump power supply has the proper voltage and allows sufficient consumption to start up the compressor.
5. The inside room temperature of the home is at least 18°C. Otherwise, the temperature has to be increased by auxiliary equipment.

7. Technical specifications

7.1. Component location

No.	Description	No.	Description
1	Production outlet	14	Brine inlet temp. probe
2	Production return	15	Production outlet temp. probe
3	Brine outlet	16	Production inlet temp. probe
4	Brine return	17	Suction pressure transducer
5	Evaporator (direct cycle)	18	Discharge pressure transducer
6	Condenser (direct cycle)	19	Brine pressure transducer
7	Compressor	20	Production pressure transducer
8	Electronic expansion valve	22	Discharge mini-pressure switch
9	Filter dryer	23	Electrical panel
10	Cycle inversion valve	24	Service outlet
11	Compressor suction temp. probe	25	Liquid level glass
12	Compressor discharge temp. probe	26	Compressor oil display
13	Brine outlet temp. probe	27	Oil solenoid valve

VOLTA W-H-H-40-400 / VOLTA W-H-H-60-400 / VOLTA W-H-H-90-400

EN

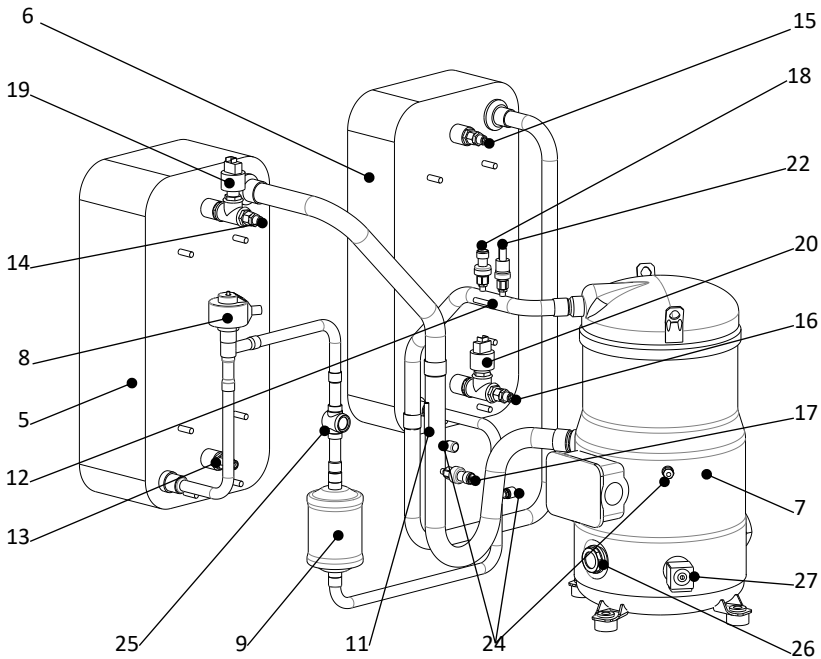
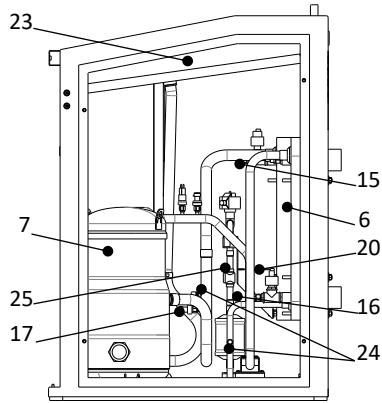
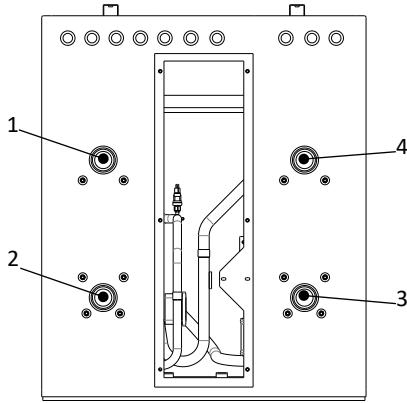
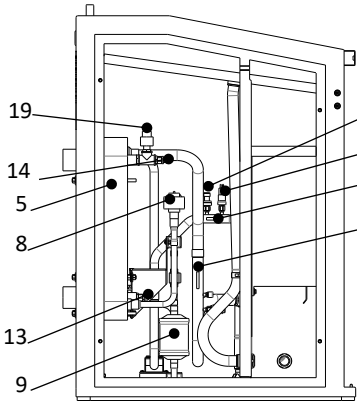
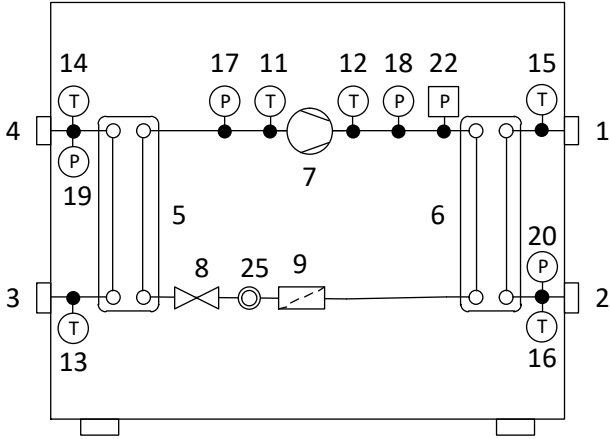

VOLTA W-H-A-40-400 / VOLTA W-H-A-60-400 / VOLTA W-H-A-90-400

EN

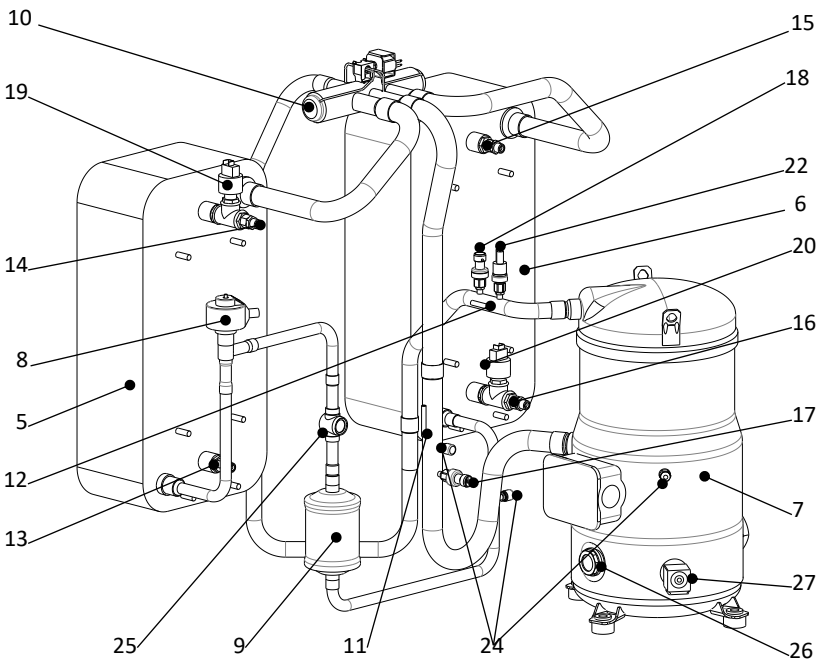
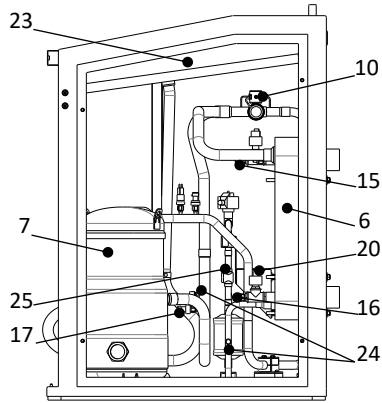
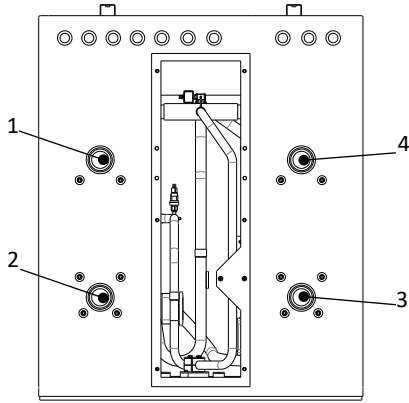
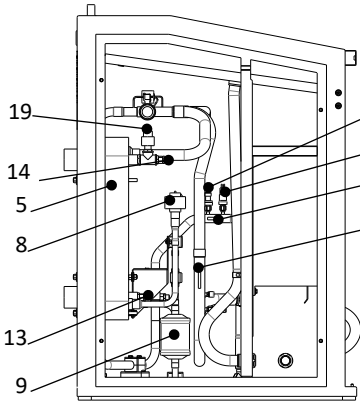
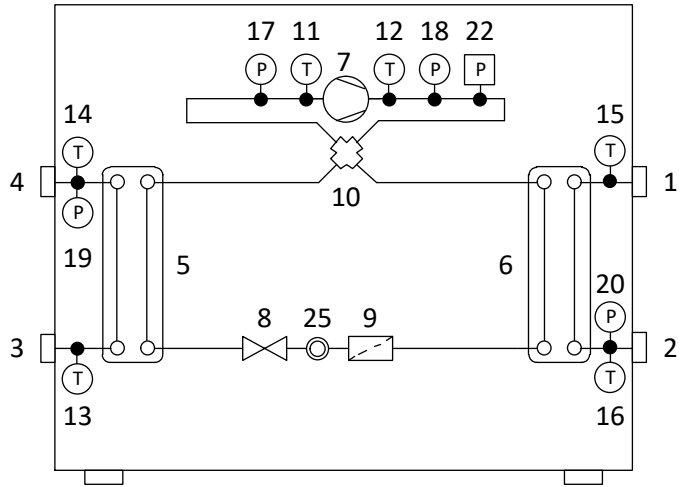

7.2. Powercircuit diagram

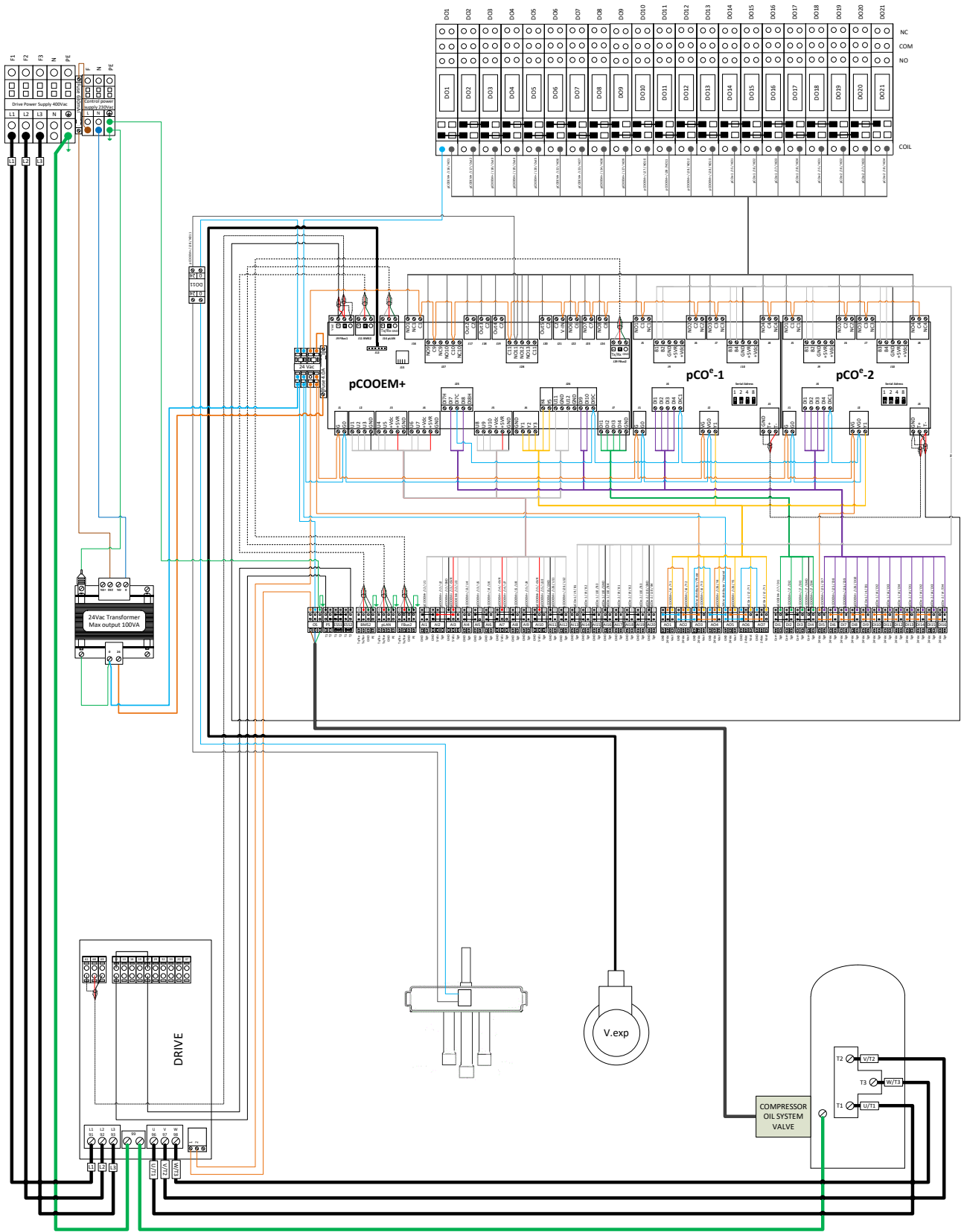

7.3. Electrical connection tables

DIGITAL OUTPUTS			
CONNECTIONS		DESCRIPTION	
Connection terminal	Controller terminal	Type	Signal
Block I / DO1	pCOOEM+ / J16 / NO1	Activation 230Vac / 8A max	Brine circulation pump
Block I / DO2	pCOOEM+ / J17 / Out2	Activation 230Vac / 8A max	Production circulation pump
Block I / DO3	pCOOEM+ / J18 / Out3	Activation 230Vac / 8A max	DHW production
Block I / DO4	pCOOEM+ / J19 / Out4	Activation 230Vac / 8A max	DHW Recirculation
Block I / DO5	pCOOEM+ / J20 / Out5	Activation 230Vac / 8A max	Pool production
Block I / DO6	pCOOEM+ / J22 / NO6	Activation 230Vac / 8A max	DG1 group production
Block I / DO7	pCOOEM+ / J23 / NO7	Activation 230Vac / 8A max	SG2 group production
Block I / DO8	pCOOEM+ / J24 / NO8	Activation 230Vac / 8A max	SG3 group production
Block I / DO9	pCOOEM+ / J27 / NO9	Activation 230Vac / 8A max	SG4 group production / Auxiliary cooling
Block I / DO10	pCOOEM+ / J27 / NO10	Activation 230Vac / 8A max	SG5 group production / Auxiliary boiler
Block I / DO11	pCOOEM+ / J28 / NO11	Activation 230Vac / 8A max	Active cooling production
Block I / DO12	pCOOEM+ / J28 / NO12	Activation 230Vac / 8A max	Passive cooling production
Block I / DO13	pCOOEM+ / J28 / NO13	Activation 230Vac / 8A max	Alarm signal
Block I / DO14	pCOe-1 / J5 / NO1	Activation 230Vac / 8A max	Auxiliary brine circulation pump
Block I / DO15	pCOe-1 / J6 / NO2	Activation 230Vac / 8A max	Cooling auxiliary circulator pump
Block I / DO16	pCOe-1 / J7 / NO3	Activation 230Vac / 8A max	Heating / cooling consumption
Block I / DO17	pCOe-1 / J8 / NO4	Activation 230Vac / 8A max	DHW inter-accumulator resistor
Block I / DO18	pCOe-2 / J5 / NO1	Activation 230Vac / 8A max	Buffer storage tank resistor
Block I / DO19	pCOe-2 / J6 / NO2	Activation 230Vac / 8A max	Not used
Block I / DO20	pCOe-2 / J7 / NO3	Activation 230Vac / 8A max	Not used
Block I / DO21	pCOe-2 / J8 / NO4	Activation 230Vac / 8A max	Not used

PROTECTIONS		
CONNECTIONS	DESCRIPTION	
Connection terminal	Type	Signal
Block II / PS1	Safety switch	High pressure switch
Block II / ESS1	Safety switch	External safety switch
Block II / ESS2	Safety switch	External safety switch

COMMUNICATIONS			
CONNECTIONS		CONNECTIONS	
Connection terminal	Serial port	Serial port	Serial port
Block II / BMS2	pCOOEM+ / J11 BMS2	RS485 ModBus RTU	Remote access through bus
--	pCOOEM+ / BMS card	Card communication connector	
Block II / pLAN	pCOOEM+ / J14 pLAN	RS485 ModBus RTU	Controller network connector
Block II / FBus2	pCOOEM+ / J29 FBus2	RS485 ModBus RTU	Indoor terminals thT y th-Tune

ANALOGUE INPUTS			
CONNECTIONS		DESCRIPTION	
Connection terminal	Controller terminal	Type	Signal
Block II / AI1	pCOOEM+ / J2 / U1	NTC 10K 25°C	Compressor suction temperature
Block II / AI2	pCOOEM+ / J2 / U2	Radiometer 0-5Vdc	Compressor suction pressure
Block II / AI3	pCOOEM+ / J2 / U3	Radiometer 0-5Vdc	Compressor discharge pressure
Block II / AI4	pCOOEM+ / J3 / U4	NTC 50K 25°C	Compressor discharge temperature
Block II / AI5	pCOOEM+ / J3 / U5	NTC 10K 25°C	Brine outlet temperature
Block II / AI6	pCOOEM+ / J4 / U6	NTC 10K 25°C	Brine inlet temperature
Block II / AI7	pCOOEM+ / J4 / U7	Radiometer 0-5Vdc	Brine circuit pressure
Block II / AI8	pCOOEM+ / J5 / U8	NTC 10K 25°C	Production outlet temperature
Block II / AI9	pCOOEM+ / J5 / U9	NTC 10K 25°C	Production inlet temperature
Block II / AI10	pCOOEM+ / J5 / U10	Radiometer 0-5Vdc	Production circuit pressure
Block II / AI11	pCOOEM+ / J26 / U11	NTC 10K 25°C	DHW inter-accumulatortemperature
Block II / AI12	pCOOEM+ / J26 / U12	NTC 10K 25°C	DHW recirculation temperature
Block II / AI13	pCOe-1 / J9 / B1	NTC 10K 25°C	Mixture group 2 temperature
Block II / AI14	pCOe-1 / J9 / B2	NTC 10K 25°C	Mixture group 3 temperature
Block II / AI15	pCOe-1 / J10 / B3	NTC 10K 25°C	Mixture group 4 temperature / Auxiliary cooling
Block II / AI16	pCOe-1 / J10 / B4	NTC 10K 25°C	Mixture group 5 temperature / Auxiliary boiler
Block II / AI17	pCOe-2 / J9 / B1	NTC 10K 25°C	Heating buffer temperature
Block II / AI18	pCOe-2 / J9 / B2	NTC 10K 25°C	Cooling buffer temperature
Block II / AI19	pCOe-2 / J10 / B3	NTC 10K 25°C	Pool temperature
Block II / AI20	pCOe-2 / J10 / B4	NTC 10K 25°C	Outside temperature

ANALOGUE OUTPUTS			
CONNECTIONS		DESCRIPTION	
Connection terminal	Controller terminal	Type	Signal
Block II / AO1	pCOOEM+ / J6 / Y1	0-10Vdc	Brinepumpadjustment
Block II / AO2	pCOOEM+ / J6 / Y2	0-10Vdc	Production pump adjustment
Block II / AO3	pCOOEM+ / J6 / Y3	0-10Vdc	Regulation of mixture group 2
Block II / AO4	pCOOEM+ / J26 / Y4	0-10Vdc	Regulation of mixture group 3
Block II / AO5	pCOOEM+ / J26 / Y5	0-10Vdc	Regulation of mixture group 4 / Regulation of auxiliary cooling
Block II / AO6	pCOe-1 / J2 / Y1	0-10Vdc	Regulation of mixture group 5 / Regulation of auxiliary boiler
Block II / AO7	pCOe-2 / J2 / Y1	0-10Vdc	Not used

DIGITAL INPUTS			
CONNECTIONS		DESCRIPTION	
Connection terminal	Controller terminal	Type	Signal
Block II / DI1	pCOOEM+ / J7 / DI1	Voltage free (0V)	Electrical consumption control (EVU)
Block II / DI2	pCOOEM+ / J7 / DI2	Voltage free (0V)	WINTER / SUMMER selection
Block II / DI3	pCOOEM+ / J7 / DI3	Voltage free (0V)	DHW production
Block II / DI4	pCOOEM+ / J7 / DI4	Voltage free (0V)	Pool production
Block II / DI5	pCOOEM+ / J25 / DI7	24Vdc / 24Vac	DG1 heating request
Block II / DI6	pCOOEM+ / J25 / DI8	24Vdc / 24Vac	DG1 cooling request
Block II / DI7	pCOOEM+ / J26 / DI9	24Vdc / 24Vac	SG2 heating request
Block II / DI8	pCOOEM+ / J26 / DI10	24Vdc / 24Vac	SG2 cooling request
Block II / DI9	pCOe-1 / J4 / DI1	24Vdc / 24Vac	SG3 heating request
Block II / DI10	pCOe-1 / J4 / DI2	24Vdc / 24Vac	SG3 cooling request
Block II / DI11	pCOe-1 / J4 / DI3	24Vdc / 24Vac	SG4 heating request
Block II / DI12	pCOe-1 / J4 / DI4	24Vdc / 24Vac	SG4 cooling request
Block II / DI13	pCOe-2 / J4 / DI1	24Vdc / 24Vac	SG5 heating request
Block II / DI14	pCOe-2 / J4 / DI2	24Vdc / 24Vac	SG5 cooling request
Block II / DI15	pCOe-2 / J4 / DI3	24Vdc / 24Vac	Smart Grid 1
Block II / DI16	pCOe-2 / J4 / DI4	24Vdc / 24Vac	Smart Grid 1

7.4. Load losses

VOLTA W-H-H-40-400

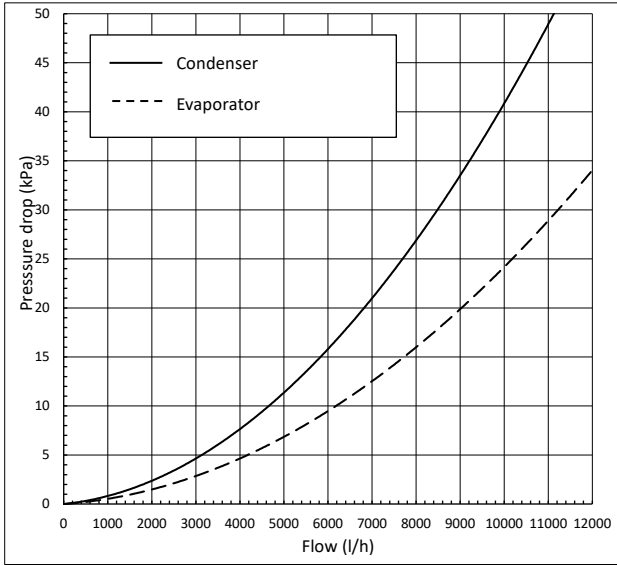

VOLTA W-H-A-40-400

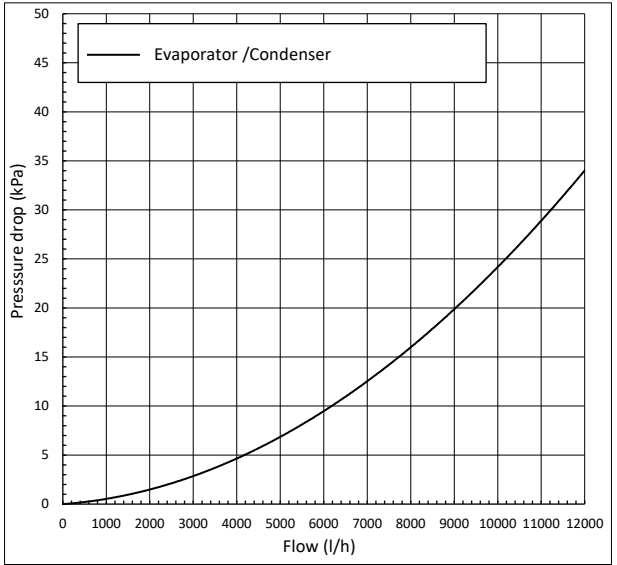

VOLTA W-H-H-60-400

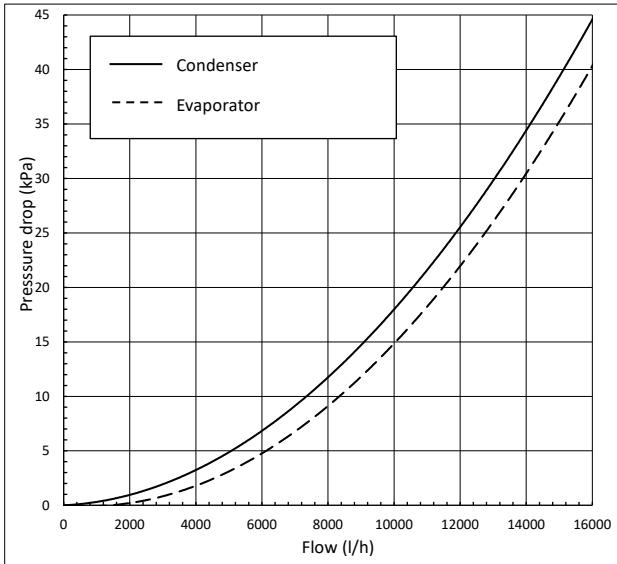

VOLTA W-H-A-60-400

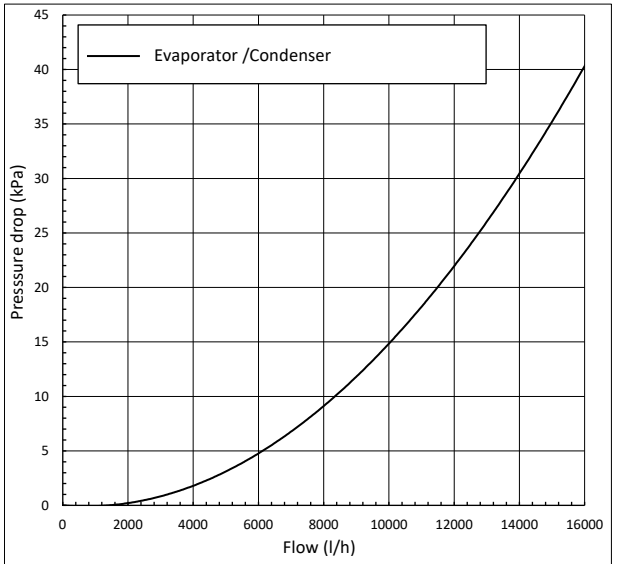

EN

VOLTA W-H-H-90-400

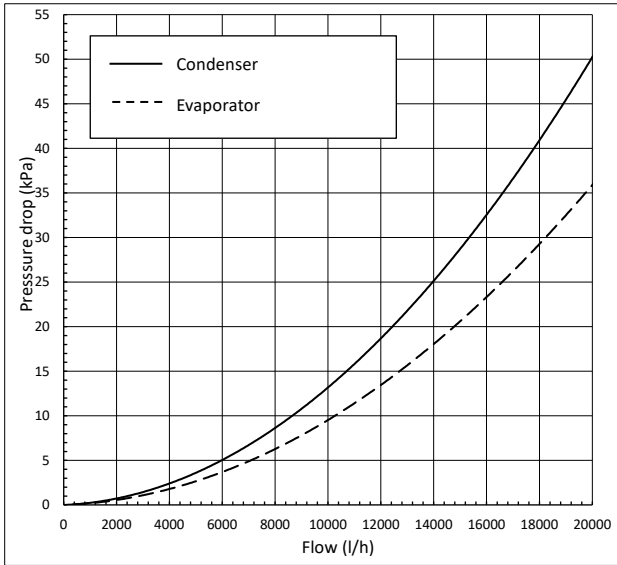

VOLTA W-H-A-90-400

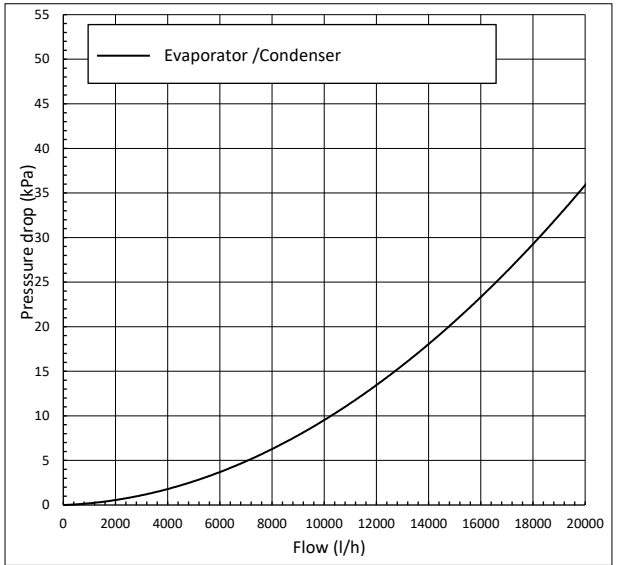

8. Operation map

VOLTA W-H-H / VOLTA W-H-A

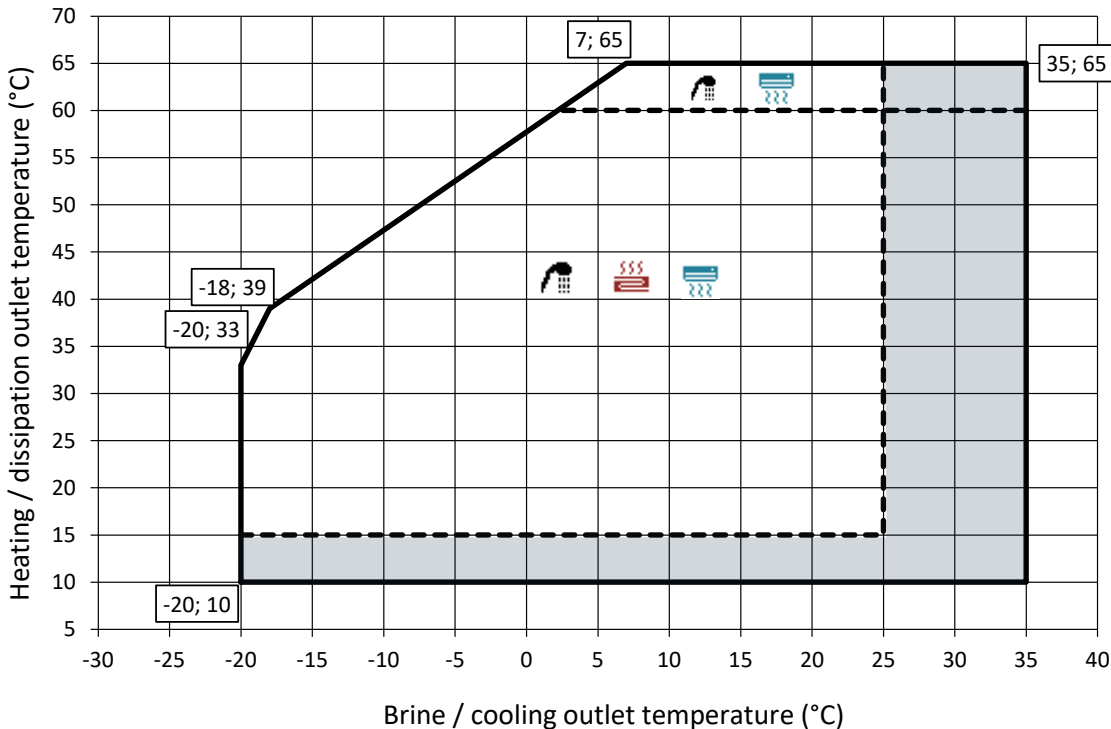

■ Map area for use with variable speed circulating pumps, managed by the VOLTA W-H heat pump.

i ■ Maximum speed of compressor is not able in all the areas of the operation map.

NOTE

9. Operation curves

VOLTA W-H-H-40-400 / VOLTA W-H-A-40-400

EN

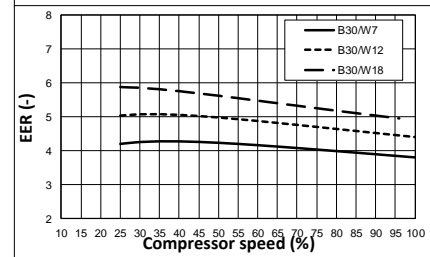
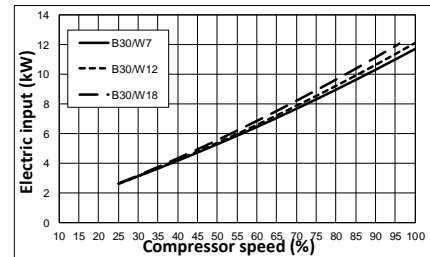
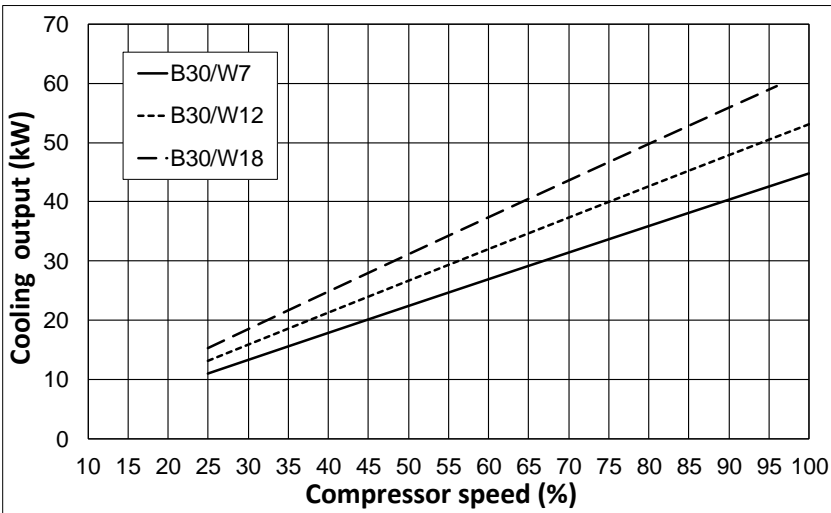
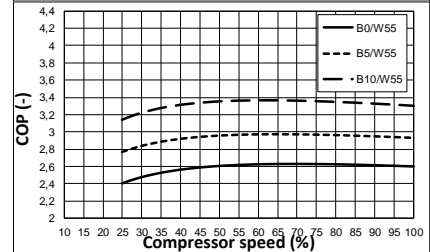
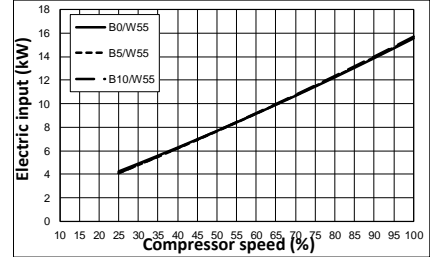
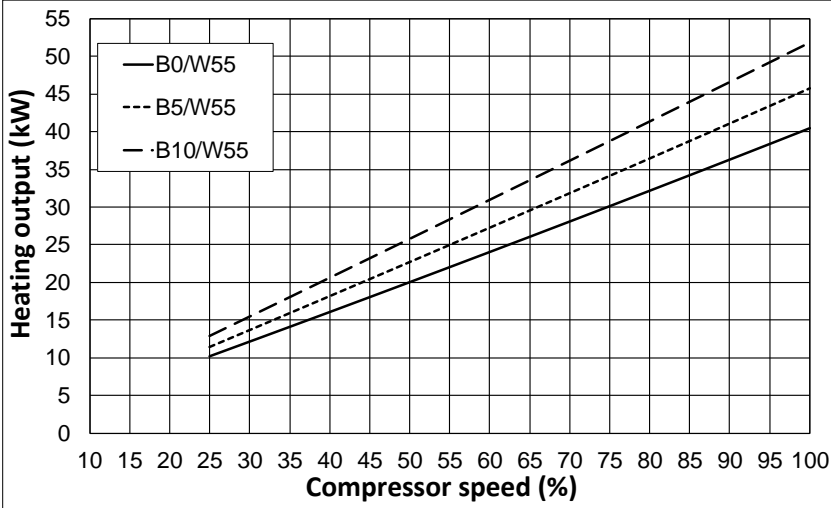
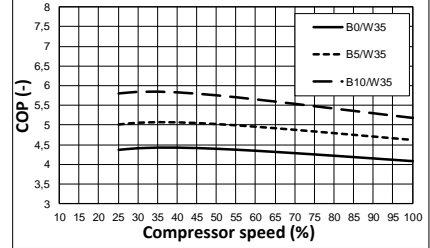
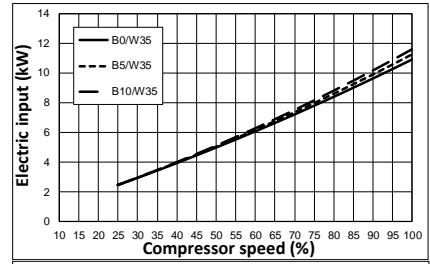
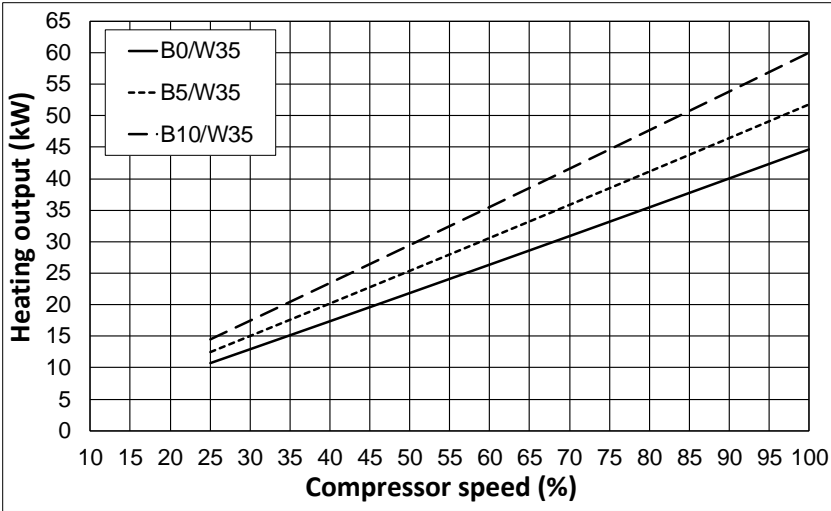

VOLTA W-H-H-60-400 / VOLTA W-H-A-60-400

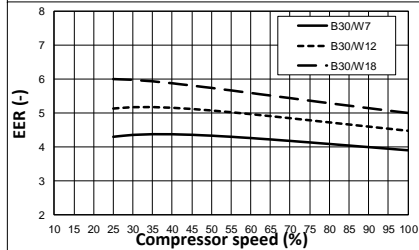
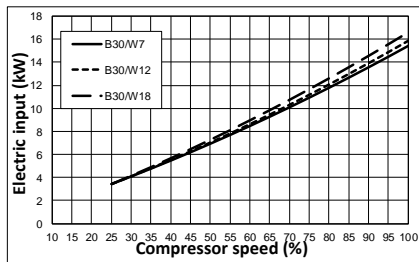
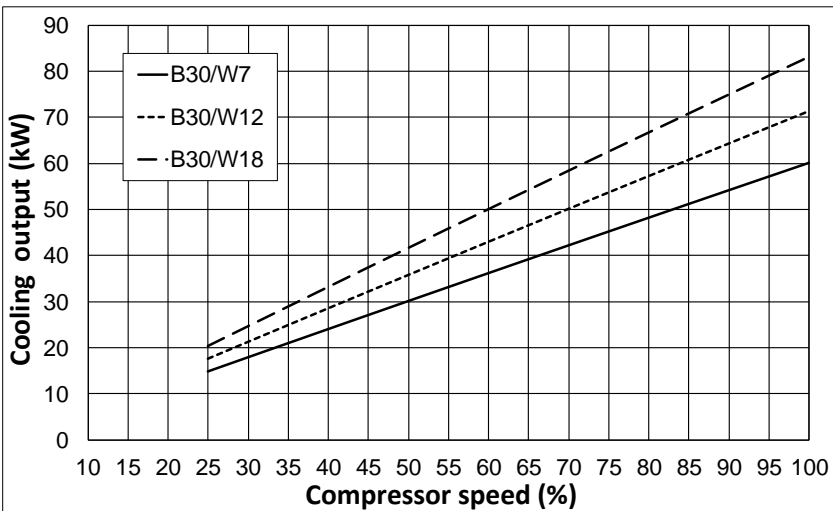
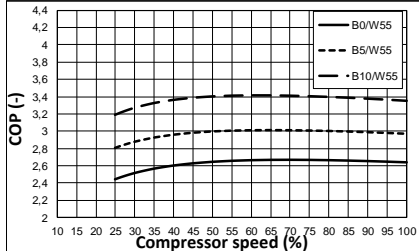
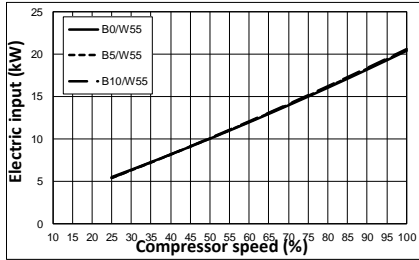
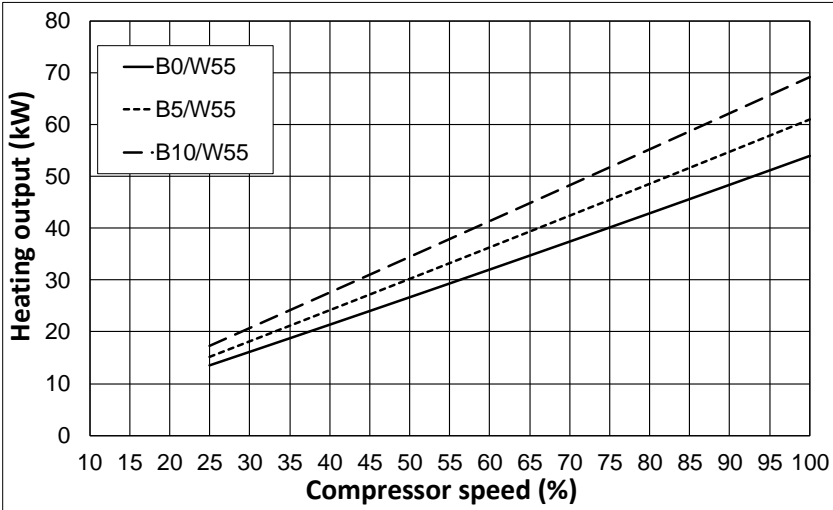
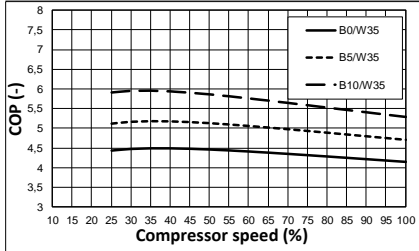
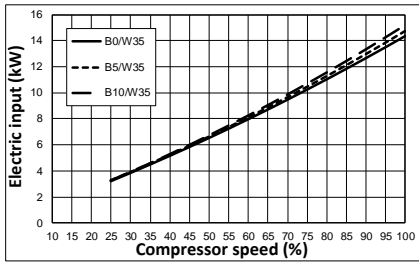
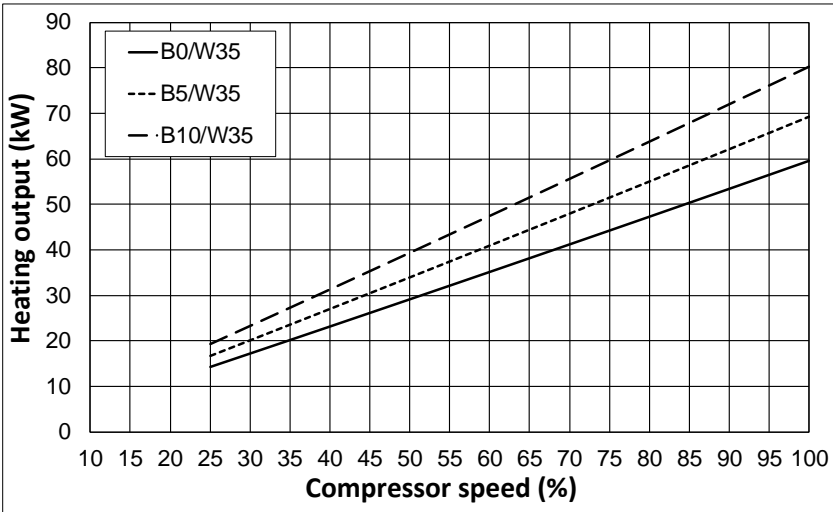

VOLTA W-H-H-90-400 / VOLTA W-H-A-90-400

EN

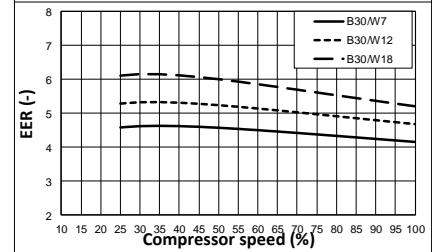
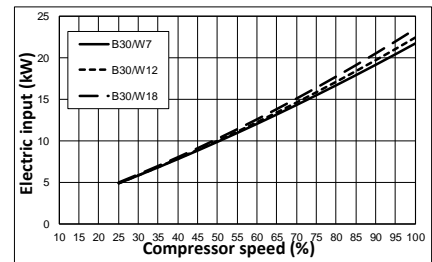
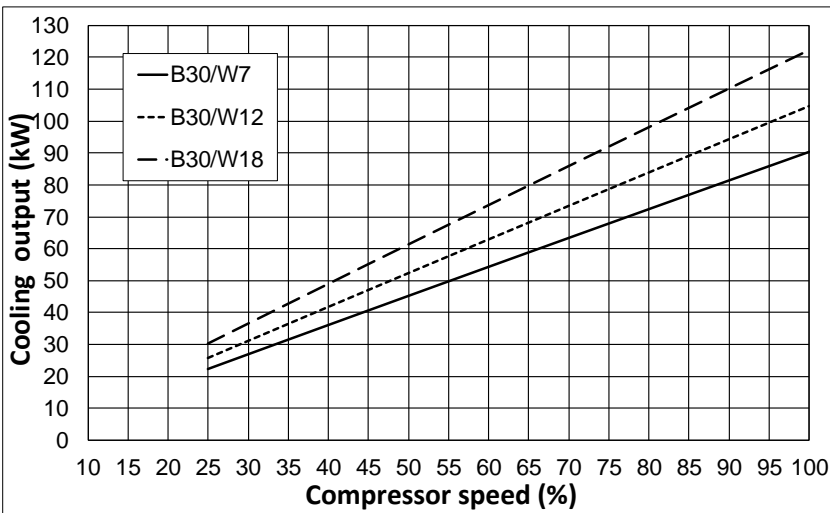
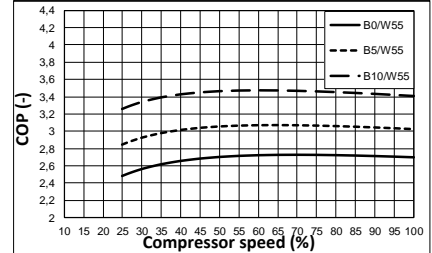
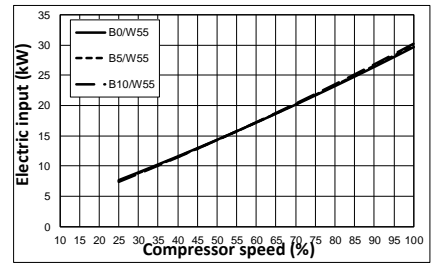
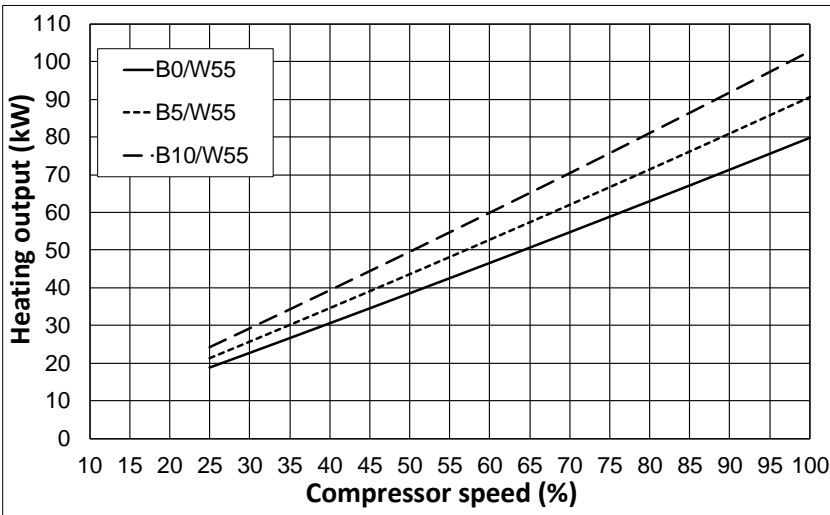
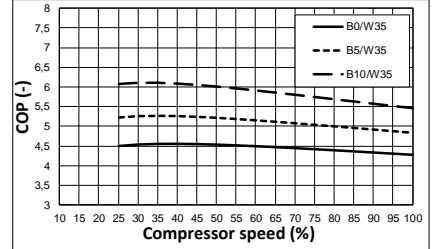
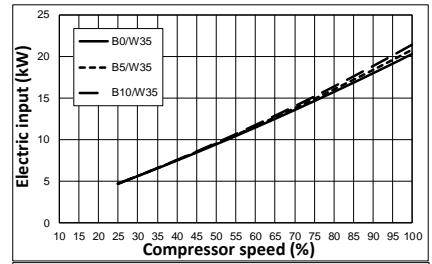
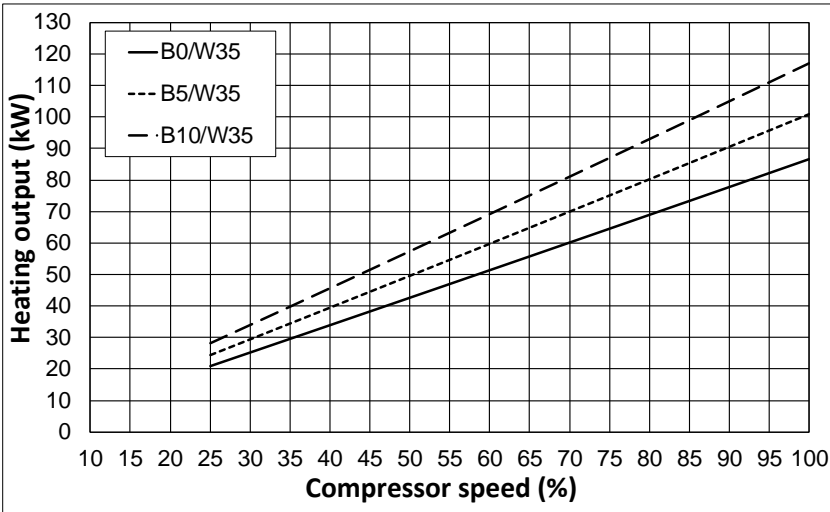

10. Technical data table



NOTE

























- In the technical data tables you will find a series of numbers in superscript format, the meaning of which is explained below:
 1. In compliance with EN 14511, this includes the consumption of the circulation pumps and the compressor driver.
 2. With variable speed circulating pumps, managed by the VOLTA W-H heat pump.
 3. In compliance with EN 12102.
 4. Starting current depends on working condition of the hydraulic circuits.
 5. Maximum consumption can vary significantly according to working conditions, or if the compressor's range of operation is restricted.
 6. The installation must be carried out in the way that guarantees the nominal flows, which will be calculated for the maximum powers with a temperature differential of 5°C. on the other hand, for the correct start-up of the compressor the installation must guarantee a higher flow rate than that resulting from the formula:
 $Q \geq 1.2 \times \text{Pref}$, where:
 - Q= Flow rate in liters per minute.
 - Pref = Colling capacity at 25% of compressor speed, see operation curves.

Specification VOLTA W-H-H-40-400 / VOLTA W-H-A-40-400		Units	VOLTA W-H-H-40-400	VOLTA W-H-A-40-400
Application	Place of installation		Indoors	
	Type of brine system		Geothermal	
	Heating, DHW with external storage tank and pool		✓	
	Integrated active cooling		--	✓
	Passive cooling control (External installation)		✓	
Performance	Compressor range of modulation	%	25 - 100	
	Heating power, B0W35 ^{1,6}	kW	10,7 - 44,6	
	COP, B0W35 ^{1,6} maximum	--	4,6	
	Active cooling power, B35W7 ^{1,6}	kW	--	11,3 - 45,8
	EER, B35W7 ^{1,6} maximum	--	--	4,4
	Maximum DHW temperature (without external heater)	°C	60	
	Sound power level ³	dB(A)	53 - 71	
	Energy label / η_s with average temperature control	--	A+++ / 193%	
Operation limits	Heating temperatures / Maximum setpoint	°C	10 - 60 / 60	
	Cooling temperatures / Min. setpoint	°C	-20 - 35 / -15	5 - 35 / 7
	Brine heating temperatures	°C	-20 - +35	
	Dissipation cooling temperatures	°C	10 - 60	
	Cooling circuit pressure min / max	bar	2 / 45	
	Heating/cooling circuit pressure	bar	0,5 to 5	
	Brine circuit pressure	bar	0,5 to 5	
Working fluids	Refrigerant type / GWP	--	R410A / 2088	
	Charge / T CO ₂ eq	Kg/ton	4,1 / 8,56	4,4 / 9,19
	Compressor oil type / amount	l	POE 160SZ / 3,3-3,8	
	Brine nominal flow, B0W35 ¹ ($\Delta T = 3 \text{ }^\circ\text{C}$) ⁶	l/h	2405 - 9830	
	Production nominal flow, B0W35 ¹ ($\Delta T = 5 \text{ }^\circ\text{C}$) ⁶	l/h	1845 - 7685	
Electrical data: Controller	1/N/PE 220-240V / 50-60 Hz	-	✓	
	Maximum recommended external protection	A	C1A	
	Transformer primary circuit fuse	A	0,630	
	Transformer secondary circuit fuse	A	4	
Electrical data: Compressor	3/PE 380-415V / 50-60Hz	--	✓	
	Maximum recommended external recommended ⁵	A	C40A	
	Maximum consumption, B0W35 ¹	kW/A	10,9/17,7	
	Maximum consumption, B0W55 ¹	kW/A	15,5/24,6	
	Maximum consumption	kW/A	18,1/28,6	
	Starting current min/max ⁴	A	5,6/9	
	Correction of cosine ϕ	--	0,96-1	
Dimensions and weight	Height x width x depth	mm	1063x870x785	
	Empty weight (without assembly)	kg	295	307

Specification VOLTA W-H-H-60-400 / VOLTA W-H-A-60-400		Units	VOLTA W-H-H-60-400	VOLTA W-H-A-60-400
Application	Place of installation		Indoors	
	Type of brine system		Geothermal	
	Heating, DHW with external storage tank and pool		✓	
	Integrated active cooling		--	✓
	Passive cooling control (External installation)		✓	
Performance	Compressor range of modulation	%	25 to 100	
	Heating power, B0W35 ^{1,6}	kW	17,1 to 59,6	
	COP, B0W35 ^{1,6} maximum	--	4,5	
	Active cooling power, B35W7 ^{1,6}	kW	--	15,1 a 61,5
	EER, B35W7 ^{1,6} maximum	--	--	4,5
	Maximum DHW temperature (without external heater)	°C	60	
	Sound power level ³	dB(A)	53 to 71	
	Energy label / η_s with average temperature control	--	A++ / 200%	
Operation limits	Heating temperatures / Maximum setpoint	°C	10 - 60 / 60	
	Cooling temperatures / Min. setpoint	°C	-20 – 35 / -15	5 – 35 / 7
	Brine heating temperatures	°C	-20 - +35	
	Dissipation cooling temperatures	°C	10 - 60	
	Cooling circuit pressure min / max	bar	2 / 45	
	Heating/cooling circuit pressure	bar	0,5 to 5	
	Brine circuit pressure	bar	0,5 to 5	
Working fluids	Refrigerant type / GWP	--	R410A / 2088	
	Charge / T CO ₂ eq	Kg/ton	4,7 / 9,81	5,5 / 11,48
	Compressor oil type / amount	l	POE 160SZ / 3,6-4,1	
	Brine nominal flow, B0W35 ¹ ($\Delta T = 3 \text{ }^\circ\text{C}$) ⁶	l/h	3230 - 13195	
	Production nominal flow, B0W35 ¹ ($\Delta T = 5 \text{ }^\circ\text{C}$) ⁶	l/h	2465 - 10265	
Electrical data: Controller	1/N/PE 220-240V / 50-60 Hz	-	✓	
	Maximum recommended external protection	A	C1A	
	Transformer primary circuit fuse	A	0,630	
	Transformer secondary circuit fuse	A	4	
Electrical data: Compressor	3/PE 380-415V / 50-60Hz	--	✓	
	Maximum recommended external recommended ⁵	A	C50A	
	Maximum consumption, B0W35 ¹	kW/A	14,3/23,2	
	Maximum consumption, B0W55 ¹	kW/A	20,4/32,3	
	Maximum consumption	kW/A	23,7/37,0	
	Starting current min/max ⁴	A	7,5/11,8	
Dimensions and weight	Correction of cosine ϕ	--	0,96-1	
	Height x width x depth	mm	1063x870x785	
	Empty weight (without assembly)	kg	322	336

Specification VOLTA W-H-H-90-400 / VOLTA W-H-A-90-400		Units	VOLTA W-H-H-90-400	VOLTA W-H-A-90-400
Application	Place of installation		Indoors	
	Type of brine system		Geothermal	
	Heating, DHW with external storage tank and pool		✓	
	Integrated active cooling		--	✓
	Passive cooling control (External installation)		✓	
Performance	Compressor range of modulation	%	25 to 100	
	Heating power, B0W35 ^{1,6}	kW	21,1 to 86,7	
	COP, B0W35 ^{1,6} maximum	--	4,5	
	Active cooling power, B35W7 ^{1,6}	kW	--	22,3 a 90,3
	EER, B35W7 ^{1,6} maximum	--	--	4,6
	Maximum DHW temperature (without external heater)	°C	60	
	Sound power level ³	dB(A)	59 to 72	
	Energy label / η_s with average temperature control	--	A+++ / 199%	
Operation limits	Heating temperatures / Maximum setpoint	°C	10 - 60 / 60	
	Cooling temperatures / Min. setpoint	°C	-20 - 35 / -15	5 - 35 / 7
	Brine heating temperatures	°C	-20 - +35	
	Dissipation cooling temperatures	°C	10 - 60	
	Cooling circuit pressure min / max	bar	2 / 45	
	Heating/cooling circuit pressure	bar	0,5 to 5	
	Brine circuit pressure	bar	0,5 to 5	
Working fluids	Refrigerant type / GWP	--	R410A / 2088	
	Charge / T CO ₂ eq	Kg/ton	7,5 / 15,66	9,1 / 19
	Compressor oil type / amount	l	POE 160SZ / 6,7-7,7	
	Brine nominal flow, B0W35 ¹ ($\Delta T = 3 \text{ }^\circ\text{C}$) ⁶	l/h	4765 - 19360	
	Production nominal flow, B0W35 ¹ ($\Delta T = 5 \text{ }^\circ\text{C}$) ⁶	l/h	3625 - 14935	
Electrical data: Controller	1/N/PE 220-240V / 50-60 Hz	-	✓	
	Maximum recommended external protection	A	C1A	
	Transformer primary circuit fuse	A	0,630	
	Transformer secondary circuit fuse	A	4	
Electrical data: Compressor	3/PE 380-415V / 50-60Hz	--	✓	
	Maximum recommended external recommended ⁵	A	C63A	
	Maximum consumption, B0W35 ¹	kW/A	20,3/31,8	
	Maximum consumption, B0W55 ¹	kW/A	29,6/45,1	
	Maximum consumption	kW/A	33,7/52,9	
	Starting current min/max ⁴	A	10,8/16,7	
	Correction of cosine ϕ	--	0,96-1	
Dimensions and weight	Height x width x depth	mm	1063x950x886	
	Empty weight (without assembly)	kg	450	465

11. Symbols

	DHW circuit		3-way valve open/closed
	Pool		3-way thermostatic valve
	Heating system		3-way modulating valve 0-10Vdc
	Cooling system		Check valve
	NTC temperature probe		Cut-off valve
	Relay thermostat		Safety valve
	Data bus communication terminal		Differential pressure valve
	Circulator pump		Particulate filter
	Direct outlet unit		Heat exchanger
	Outlet unit with mixture		Outlet pipe
	Electrical resistance		Return pipe
	Drain defrost heater		Flexible hose
	Expansion vessel		Drain

CE



VOLTA Heat Pumps

www.voltaheatpumps.com

Rúa das Pontes 25, 36350 Nigrán (Pontevedra) Spain

contact@voltaheatpumps.com

+34 986 262 184

TECHNICAL manual VOLTA W-H Gen3 Version 03.0X/2024

The manufacturer reserves the right to make any necessary changes to the contents of this manual without prior notice.