

# Air conditioner

---

## Installation manual

MCU-S6NEK2N / MCU-S4NEK3N / MCU-S2NEK2N / MCU-S1NEK1N /  
MCU-S12NEK1N / MCU-S8NEK1N

---

- Thank you for purchasing this Samsung air conditioner.
- Before operating this unit, please read this installation manual carefully and retain it for future reference.



**SAMSUNG**

# Contents

Safety precautions.....	3
Mesures de sécurité .....	5
Preparing the installation .....	7
Space requirements.....	10
Refrigerant piping.....	17
Wiring .....	20
MCU Installation Checklist .....	31



## *Correct Disposal of This Product (Waste Electrical & Electronic Equipment)*

### *(Applicable in countries with separate collection systems)*

This marking on the product, accessories or literature indicates that the product and its electronic accessories (e.g. charger, headset, USB cable) should not be disposed of with other household waste at the end of their working life. To prevent possible harm to the environment or human health from uncontrolled waste disposal, please separate these items from other types of waste and recycle them responsibly to promote the sustainable reuse of material resources.

Household users should contact either the retailer where they purchased this product, or their local government office, for details of where and how they can take these items for environmentally safe recycling.

Business users should contact their supplier and check the terms and conditions of the purchase contract. This product and its electronic accessories should not be mixed with other commercial wastes for disposal.

*(For India only)*

For more information on safe disposal and recycling, visit our website [www.samsung.com/in/support](http://www.samsung.com/in/support) or contact our Helpline numbers - 1800 40 SAMSUNG (1800 40 7267864)  
1800 5 SAMSUNG (1800 5 7267864).

For correct disposal of this product, please visit <http://www.samsung.com/weee.pdf>



FR

Cet appareil,  
ses accessoires,  
piles et cordons  
se recyclent

REPRISE  
À LA LIVRAISON



OU

À DÉPOSER  
EN MAGASIN



OU

À DÉPOSER  
EN DÉCHÈTERIE



Points de collecte sur [www.quefairedemesdechets.fr](http://www.quefairedemesdechets.fr)  
Privilégiez la réparation ou le don de votre appareil !

# Safety precautions

The safety information and precautions below must be kept for the safety of users and installers.

Before installing an air conditioner, please read this manual thoroughly to ensure that you know how to safely and efficiently install a new appliance.

\* This product uses R-410A refrigerant.

- When using R-410A, moisture or foreign substances may affect the capacity and reliability of the product. Safety precautions must be taken when installing the refrigerant pipe.
- The designing pressure of the system is 4.1 MPa. Select appropriate material and thickness according to the regulations.
- R-410A is a quasi-azeotrope of two refrigerants. Make sure to charge with liquid phase when filling refrigerant.

If you charge gaseous refrigerant, it may affect the capacity and reliability of the product as a result of change formation of the refrigerant.

\* Connect the indoor units for R-410A refrigerant. Check whether the indoor units can be connected with the product's catalogue. (When incorrect indoor units are connected, they cannot operate normally.)

- \* After installation and trial operation, explain to the customer how to use the air conditioner and give the installation manual to the user.
- \* The manufacturer is not responsible for accidents due to incorrect installation. Any claims caused by failing to keep the safety precautions are installer's responsibility. (The installer is responsible for the service cost.)
- \* This appliance is not intended for use by persons (including children) with reduced physical, sensory or mental capabilities, or lack of experience and knowledge, unless they have been given supervision or instruction concerning use of the appliance by a person responsible for their safety. Children should be supervised to ensure that they do not play with the appliance.
- \* If the supply cord is damaged, it must be replaced by the manufacturer, its service agent or similarly qualified persons in order to avoid a hazard.



## WARNING

In case of not following the safety precautions, the service agent or the user may get the risk of serious wound or death.



## CAUTION

In case of not following the safety precautions, the service agent or the user may get the risk of injury or loss of property.

## FOR INSTALLATION



## WARNING

**Installation must be done by the installer or its service agent.**

▶ Installation by an unqualified person may cause a water leakage, electric shock or fire and so on.

**Install the unit correctly according to the installation manual.**

▶ An incorrect installation may cause a water leakage, electric shock or fire.

**When installing the unit in a small place, take measures in order to keep the refrigerant concentration from exceeding allowable safety limits in the event of a refrigerant leak.**

▶ Excessive refrigerant concentration can lead to suffocation.

**If any gas or impurities except R-410A refrigerant get into the refrigerant pipe, serious problems may occur and this may cause injury.**

**When installing the unit, only use the components and tools which are specified for the installation.**

▶ Using the uncertified components and tools may cause a unit fall, water leakage, electric shock, and a fire.

(Never use the components and pipe for R-22 refrigerant)

**Install the unit safely on a place that can support its weight.**

▶ If the place cannot support its weight, the unit may fall down and cause injury.

**Check out the safety precautions below before installing or fixing the unit.**

▶ Before welding the unit, you must remove all the hazardous materials around the unit that may cause an explosion and a fire.

▶ When refrigerant is in the product or the pipe before welding the unit, you must remove the refrigerant.

- If you weld the unit when there is refrigerant inside, the increased pressure of refrigerant may explode or break the leaking spot so that causes serious injuries.

▶ When welding the unit, please use nitrogen gas to prevent oxide from generating in the pipe

**Make sure to cut off all the power supply before installing, fixing, and cleaning the unit.**

**When the electric wire is damaged, you must exchange it by the manufacturer or its service agent, or a person who has the equivalent qualification.**

**When turning on the power, make sure to connect the power supply to the circuit breaker designated for indoor units. (ELCB, ELB, MCCB)**

▶ If you do not install the circuit breaker for MCU(ELCB, ELB, MCCB), excessive current or failure to blocking the power supply may cause electric shock, a fire.

# Safety precautions

---

## FOR INSTALLATION



## WARNING

**Make sure to connect wires thoroughly and fix them firmly so that no outer pressure of the wires would put on the terminal block.**

- ▶ If the terminal is loose, it may generate heat and cause a fire.

**Supplied power should be more or less than 2% of the rated power.**

- ▶ If the power is supplied unevenly, a life span of the storage battery shortens. If the supplied power is more than 4 % of the rated power, the unit terminates and indicates errors to protect it.

**Make sure the interior power supply shouldn't be over the maximum voltage or under the minimum voltage.**

- ▶ Otherwise, it could result in malfunction of the unit due to damaged electrical components or decreased function of components.

**Only use copper wire as the power cable and all wiring, components and materials should comply with the applicable local and national codes.**

**Make sure that all wiring is properly installed.**

- ▶ Otherwise, the unit can be heated and cause a fire.

**Never use the pipe and flare parts for R-22 refrigerant.**

**In case of a refrigerant gas leakage during installation, please ventilate the area.**

- ▶ If refrigerant gas combines with inflammable materials, toxic gases can be generated.

**The electric work must be done by service agent or qualified persons according to national wiring regulations and use only rated cable.**

- ▶ Voltage drop, shortage of power supply, improper electric work and using unapproved wires can cause an electric shock or a fire.

## FOR INSTALLATION



## CAUTION

**Make sure to earth.**

- ▶ Do not connect the earth wire to the gas pipe, lighting rod or telephone wire.
- ▶ If earthing is incomplete, electric shock or fire may occur.

**Make sure that the condensed water from the drain hose runs out properly based on this installation manual and insulate the drain pipe so that frost does not generate.**

- ▶ If the draining work is done incompletely, property damage may occur due to a leakage.

**Install the power cable and communication cable of MCU at least 1m away from the electric appliances and at least 2m away from the lightning rod.**

- ▶ However, you may hear a noise 1 meter away from the unit depending on the condition of the electric wave.

**Install MCU away from lighting apparatus using the ballast.**

- ▶ If you use the wireless remote control, it may not operate normally.

**Do not install the unit in following places.**

- ▶ The place packed with mineral oil and the place where there are lots of moisture, or arsenic acid:  
The resin parts may burn and cause the fall of the components or a refrigerant leakage.
- ▶ The place where corrosive gas such as sulfurous acid gas generates from the vent pipe or air outlet:  
The copper pipe or connection pipe may corrode and refrigerant may leak.
- ▶ The place where there is a machine that generates electromagnetic waves:  
The unit may not operate normally due to malfunction in the control system.
- ▶ The place where there is a possibility of combustible gas leakage, and where inflammable materials like thinner or gasoline is handled. The place where a carbon fiber or inflammable dust is floating in the air:  
If the gas leaks and stays around the main valve, it may result in a fire.
- ▶ The places where have a possibility of the MCU corrosion like a spa and a shore.

**When there is a possibility that the place in which MCU is installed could be the shelter of small animals, take proper measures to prevent this situation in advance.**

- ▶ If small animals contact the unit, this may result in malfunction of the unit or cause a fire and smoke. Please remind users of cleaning the place around MCU.

\* Any claims caused by failing to keep the safety precautions are installer's responsibility.  
(The installer is responsible for the service cost.)

# Mesures de sécurité

Les renseignements sur la sécurité et les précautions ci-dessous doivent être conservés pour garantir la sécurité des utilisateurs et des installateurs.

Avant d'installer un climatiseur, veuillez lire attentivement ce manuel pour vous assurer que vous savez comment installer efficacement et en toute sécurité un nouvel appareil.

\* Ce produit utilise du fluide frigorigène R-410A.

- Lors de l'utilisation de R-410A, l'humidité ou les substances étrangères risquent d'affecter les capacités et la fiabilité du produit. Des précautions de sécurité doivent être respectées lors de l'installation du conduit de fluide frigorigène.
- La pression de conception du système est de 4,1 MPa. Sélectionnez les matériaux et les épaisseurs conformément aux réglementations en vigueur.
- Le R-410A est un quasi-azéotrope de deux fluides frigorigènes. Assurez-vous de charger le fluide frigorigène en phase liquide.

Si vous chargez un réfrigérant gazeux, cela risque d'affecter la capacité et la fiabilité du produit suite à un changement dans la formation du fluide frigorigène.

\* Connecter des unités intérieures adaptées au fluide frigorigène R-410A. Vérifiez si les unités intérieures peuvent être raccordées au produit. (Si des unités intérieures incompatibles sont raccordées, elles ne pourront pas fonctionner normalement.)

\* Après l'installation et les tests, expliquez au client comment utiliser le climatiseur et donnez-lui le manuel d'installation.

\* Le fabricant n'est pas responsable des incidents dus à une installation incorrecte. Toute réclamation consécutive à l'inobservation des précautions de sécurité est à la responsabilité de l'installateur. (L'installateur est responsable du coût du service.)

\* Cet appareil n'est pas conçu pour les personnes (notamment les enfants) ayant une capacité physique, sensorielle ou mentale réduite ou un manque d'expérience et de connaissance, à moins qu'elles ne soient supervisées ou qu'elles n'aient reçu les instructions d'une personne responsable concernant l'utilisation de l'appareil en toute sécurité. Les enfants doivent être supervisés pour s'assurer qu'ils ne jouent pas avec l'appareil.

\* Si le cordon d'alimentation est endommagé, il doit être remplacé par le fabricant, son agent de service ou des personnes qualifiées afin d'éviter tout danger.



## AVERTISSEMENT

En cas de non-respect des précautions de sécurité suivantes, l'agent de service ou l'utilisateur a des risques de blessure grave ou mortelle.



## MISE EN GARDE

En cas de non-respect des précautions de sécurité suivantes, l'agent de service ou l'utilisateur courent des risques de blessure ou de dommages matériels.

## MONTAGE



## AVERTISSEMENT

L'installation doit être faite par l'installateur ou son agent de service.

► Une installation faite par une personne non qualifiée risque de provoquer une fuite d'eau, une décharge électrique, un incendie et ainsi de suite.

**Installez l'appareil conformément au manuel d'installation.**

► Toute installation incorrecte peut entraîner une fuite d'eau, une décharge électrique ou un incendie.

**Lors de l'installation de l'appareil dans un espace restreint, prenez les mesures appropriées pour éviter que la concentration en fluide frigorigène ne dépasse les limites de sécurité autorisées en cas de fuite de fluide.**

► Une concentration excessive de fluide frigorigène peut provoquer une suffocation.

**Si des gaz ou des impuretés pénètrent avec le fluide frigorigène R-410A dans le tuyau réfrigérant, des problèmes graves peuvent survenir et provoquer des blessures.**

**Pour l'installation de l'appareil, utilisez uniquement les composants et les outils qui ont été spécifiés pour l'installation.**

► L'utilisation de composants et d'outils non certifiés peut entraîner la chute de l'appareil, des fuites d'eau, un choc électrique ou un incendie. (N'utilisez jamais des composants et des tuyaux conçus pour le fluide frigorigène R-22)

**Installez l'appareil en toute sécurité à un emplacement qui peut supporter son poids.**

► Si l'emplacement prévu ne peut pas supporter le poids de l'appareil, celui-ci peut tomber et provoquer des blessures.

**Consultez les précautions de sécurité ci-dessous avant d'installer et de fixer l'appareil.**

► Avant de souder l'appareil, vous devez retirer tous les matériaux dangereux qui se trouvent autour, car ceux-ci pourraient provoquer une explosion et un incendie.

► Si du fluide frigorigène se trouve dans l'appareil ou dans les tuyaux avant le soudage, vous devez retirer le réfrigérant avant toute opération.  
- Si vous soudez l'appareil alors que du fluide frigorigène se trouve à l'intérieur, la pression accrue du réfrigérant pourrait provoquer une explosion et entraîner des blessures graves.

► Lors du soudage de l'appareil, veuillez utiliser de l'azote gazeux pour empêcher la génération d'oxyde dans le tuyau.

**Assurez-vous de couper toutes les alimentations électriques avant l'installation, la fixation et le nettoyage de l'appareil.**

**En cas de détérioration d'un fil électrique, vous devez faire procéder à son remplacement par le fabricant ou son agent de service, ou une personne ayant les qualifications équivalentes.**

**Lorsque vous mettez l'appareil sous tension, veillez à effectuer le raccordement à un disjoncteur conçu pour les unités intérieures. (ELCB, ELB, MCCB)**

► Si vous n'installez pas de disjoncteur pour la MCU (ELCB, ELB, MCCB), une surintensité ou l'incapacité de couper l'alimentation électrique pourrait provoquer un choc électrique ou un incendie.

# Mesures de sécurité

## MONTAGE

## AVERTISSEMENT

**Veillez à bien serrer les fils et à les fixer fermement afin qu'aucune pression extérieure sur les câbles ne puisse provoquer une traction sur le bornier.**

► Si une cosse est mal serrée, cela peut générer de la chaleur et provoquer un incendie.

**L'alimentation électrique fournie peut être supérieure ou inférieure de 2 % par rapport à la tension nominale.**

► Si l'alimentation électrique fournie n'est pas stable, cela raccourcit la longévité des batteries de stockage. Si l'alimentation électrique fournie dépasse de plus de 4 % la tension nominale, l'appareil s'arrête et affiche les erreurs qui ont entraîné sa mise en protection.

**Veillez à ce que l'alimentation électrique de l'unité intérieure ne soit ni supérieure ni inférieure à la tension nominale.**

► Faute de quoi, l'appareil risque de connaître des dysfonctionnements causés par des composants électriques endommagés ou une baisse de rendement de ses composants.

**Utilisez uniquement des fils en cuivre pour le câble d'alimentation. Tous les câblages, composants et matériels doivent être conformes aux réglementations locales et nationales en vigueur.**

**Veillez à ce que tous les câblages soient installés correctement.**

► Faute de quoi, l'appareil pourrait surchauffer et provoquer un incendie.

**N'utilisez jamais des tuyaux et des pièces évasées conçus pour le fluide frigorigène R-22.**

**En cas de fuite de gaz réfrigérant pendant l'installation, veuillez ventiler la zone.**

► Si du gaz réfrigérant se combine avec des matériaux inflammables, des gaz toxiques pourraient se former.

**Les travaux d'électricité doivent être réalisés par un agent de service ou des personnes qualifiées conformément aux réglementations nationales sur le câblage, et seul du câble conforme doit être utilisé.**

► Une baisse de tension, une coupure d'alimentation électrique, des travaux d'électricité incorrects et l'utilisation de fils non approuvés peuvent provoquer un choc électrique ou un incendie.

## MONTAGE

## MISE EN GARDE

**Veillez à effectuer une mise à la terre conforme.**

► Ne connectez pas le fil de mise à la terre au tuyau de gaz, au paratonnerre ou au fil de téléphone.

► L'absence de mise à la terre est susceptible de provoquer un choc électrique ou un incendie.

**Veillez à ce que les condensats s'évacuent correctement par le tuyau de vidange conformément aux recommandations du présent manuel d'installation, et isolez le tuyau de vidange afin d'éviter la formation de givre.**

► Si l'installation de la vidange est faite de façon incomplète, des dommages matériels provoqués par des fuites d'eau peuvent survenir.

**Installez le câble d'alimentation et le câble de communication de la MCU à une distance d'au moins 1 m des appareils électriques et à au moins 2 m du paratonnerre.**

► Cependant, vous pourrez entendre un bruit à 1 m à l'écart de l'appareil en fonction des conditions de l'onde électrique.

**Installez la MCU loin de tout dispositif d'éclairage utilisant un ballast.**

► Si vous utilisez la télécommande sans fil, son fonctionnement peut être altéré.

**N'installez pas l'appareil dans les lieux suivants.**

► Tout endroit contenant une grande quantité d'huile minérale, de moisissures ou d'acide arsénique :

Les parties en résine pourraient brûler et provoquer la chute des composants ou une fuite de fluide frigorigène.

► Les zones où des gaz corrosifs, comme de l'acide sulfurique, s'échappent du tuyau de ventilation ou de la sortie d'air :

Le tuyau de cuivre ou de connexion risque de se corroder et le liquide réfrigérant pourrait fuir.

► Les emplacements dans lesquels un appareil génère des ondes électromagnétiques :

Des problèmes dans le système de commande peuvent entraîner un mauvais fonctionnement de l'appareil.

► Lieu où il y a un danger de fuite de gaz combustible, et où des matières inflammables, telles que du diluant et de l'essence, sont manipulés.

Lieu où de la fibre de carbone ou de la poussière inflammable est en suspension dans l'air :

Si le gaz fuit et reste autour de la vanne principale, cela peut déclencher un feu.

► Lieu où il y a une possibilité de corrosion de la MCU, tel un spa ou un bord de mer.

**Lorsqu'il y a la possibilité que le lieu où la MCU va être installée soit utilisé comme un abri par de petits animaux, prenez les mesures nécessaires pour éviter toute intrusion.**





► Si de petits animaux entrent en contact avec l'appareil, cela peut entraîner son dysfonctionnement, voire un incendie et de la fumée. Veuillez rappeler aux utilisateurs de nettoyer les lieux aux alentours de la MCU.

\* Toute réclamation consécutive à l'observation des précautions de sécurité est la responsabilité de l'installateur.  
(L'installateur est responsable du coût du service.)

# Preparing the installation

## Accessories

Please check if items below are included in installation accessories.

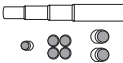
Name	Insulation (for pipe)	Insulation (for base)	Installation manual	Pattern sheet	Cable tie	Pipe socket	
						MCU-S1* MCU-S2*	MCU-S4* MCU-S6* MCU-S8* MCU-S12*
Shape						-	

\* Soundproof and soundproofing materials

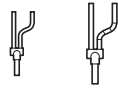
Name	MXJ-YM1509M
Shape	

## Selecting the refrigerant pipe for installation

The design pressure of MCU for R-410A is about 4.1 MPa (594.6psi). For safe use of the product, please refer to the table below in selecting the installation pipe.

Outer diameter		Minimum thickness		Temper grade
mm	inch	mm	inch	
6.35	1/4	0.70	0.028	Annealed
9.52	3/8	0.70	0.028	
12.70	1/2	0.80	0.031	
15.88	5/8	1.00	0.039	
19.05	3/4	0.90	0.035	
22.22	7/8	0.90	0.035	Drawn
25.40	1	1.00	0.039	
28.58	1 1/8	1.10	0.043	
31.75	1 1/4	1.10	0.043	
34.92	1 3/8	1.21	0.048	
38.10	1 1/2	1.35	0.053	
41.28	1 5/8	1.43	0.056	
44.45	1 3/4	1.60	0.063	
50.80	2	2.00	0.079	
53.98	2 1/8	2.10	0.083	



• For pipes larger than Ø 19.05mm(3/4"), drawn type (C1220T-1/2H or C1220T-H) type copper pipe must be used. If an annealed type (C1220T-O) copper pipe is used, pipe may break due to its low pressure resistance and cause personal injury.



• Pour les tuyaux de diamètre supérieur à Ø 19,05 mm (3/4"), du cuivre étiré (C1220T-1/2H ou C1220T-H) doit être utilisé. Si du tuyau en cuivre recuit (C1220T-O) est utilisé, une rupture est possible compte tenu de sa faible résistance à la pression, ce qui peut provoquer des blessures.

# Preparing the installation

## MCU indoor/outdoor unit compatible table

Before installing MCU, refer to the compatible table below and find the model before installation.

Outdoor unit	MCU	Indoor unit
AM*****X*****	MCU-S6NEK2N MCU-S4NEK3N MCU-S2NEK2N MCU-S1NEK1N MCU-S12NEK1N MCU-S8NEK1N	AM*****N*****

	Model	Description
MCU Kit	MCU-S6NEK2N	below 61.6 kW (216MBH)
	MCU-S4NEK3N	below 61.6 kW (216MBH)
	MCU-S2NEK2N	below 32 kW (108MBH)
	MCU-S1NEK1N	below 16 kW (54MBH)
	MCU-S12NEK1N	85.0 kW (290MBH)
	MCU-S8NEK1N	85.0 kW (290MBH)

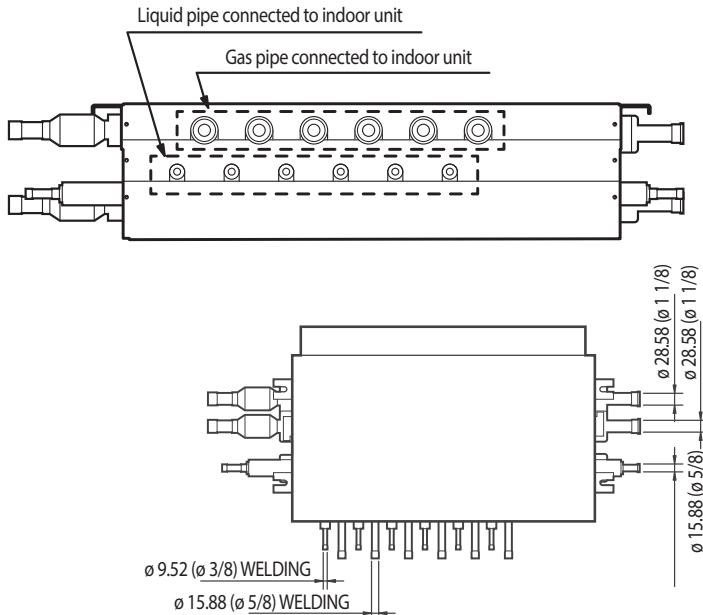

[Unit : mm(inch)]

<MCU-S6NEK2N, MCU-S4NEK3N, MCU-S2NEK2N>



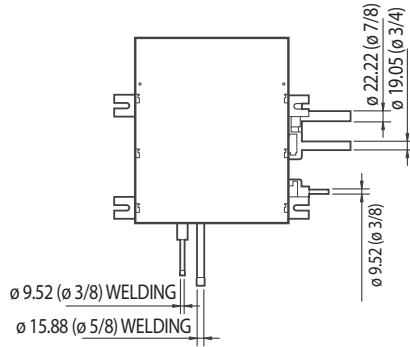
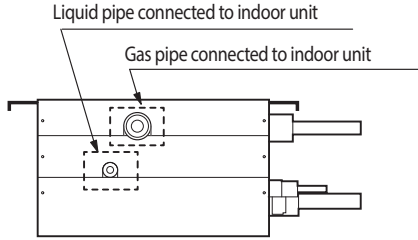

<MCU-S1NEK1N>

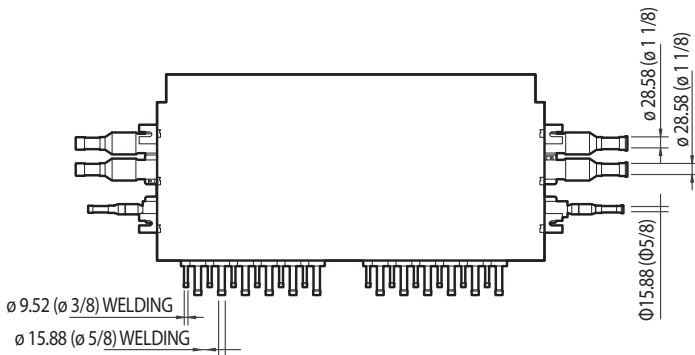
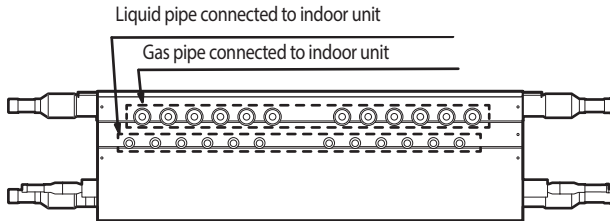

<MCU-S12NEK1N, MCU-S8NEK1N>

# Space requirements

1. Refrigerant noise can be generated during MCU operation. Do not install the unit in spaces that require silence, such as bedrooms, libraries, hospitals, offices etc.
2. Do not install the MCU in the ceiling of living spaces. Noise generated from the MCU may disrupt occupant comfort.

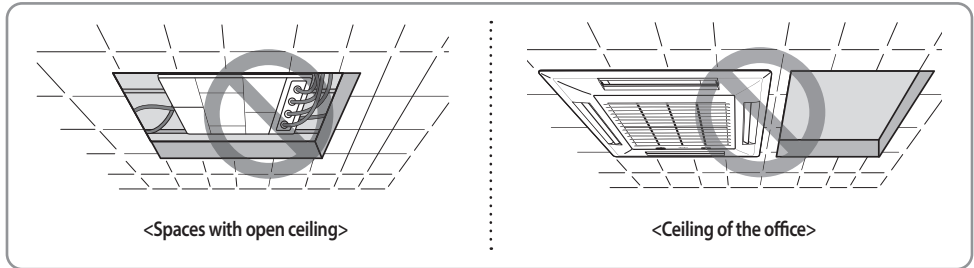

3. It is normally recommended to install MCU in a hallway but a bulkhead should be installed to minimize the noise from being transferred to living area. (Refer to the below figure)

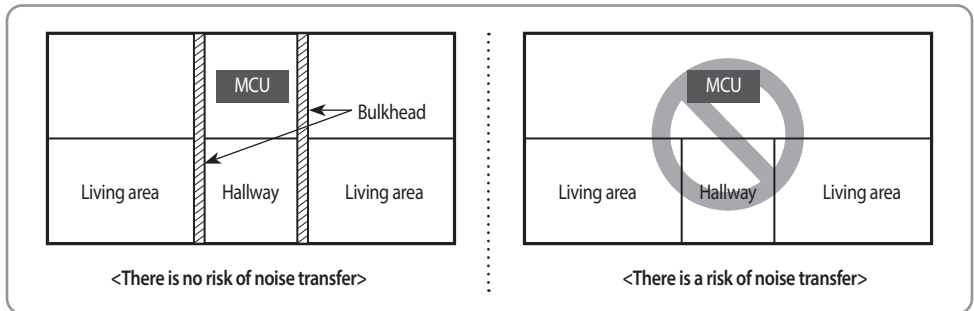

## \* Soundproof and soundproofing materials

- ▶ The place where MCU is installed and the interior walls should have a high soundproof ability. (Bricks, Concretes, Cement)
  - ▶ The ceiling where MCU is installed should be coated with quality textile that has a good soundproof function.
  - ▶ Minimize the size of the hole between the walls and the pipe connection. After the installation, block the gap to prevent noise from leaking.
4. Secure over 0.25m(0.82') of space when MCU is being fixed to the concrete of the ceiling.
  5. MCU may generate noise so don't install it too close to the ceiling textile.
  6. Each pipe hanger should be placed at 1.5m(4.92') interval to support its weight firmly. If the pipe or the hanger isn't fixed firmly, the unit may fall and cause a property damage or loss of life.
  7. When 'Low temperature cooling range expansion' option is set for constant cooling operation throughout the year, noise of the MCU may get louder during wintertime. Therefore, above installation requirements must be followed.

8. Select a place where the structure can support the weight of the MCU and indoor units that also have strong vibration resistance without any slope.  
If the structure is not strong enough, MCU may fall down and cause injury.

\*Height (mm)

MCU-S6*	199
MCU-S4*	
MCU-S2*	
MCU-S1*	
MCU-S12*	298
MCU-S8*	

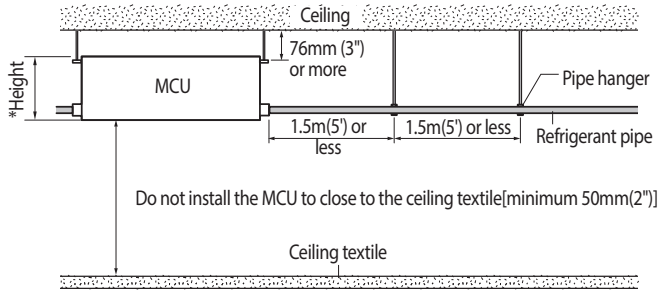

9. Select an installation location with enough space for service and repair.  
Leave enough space between adjacent walls and structures. Refer to the examples below.

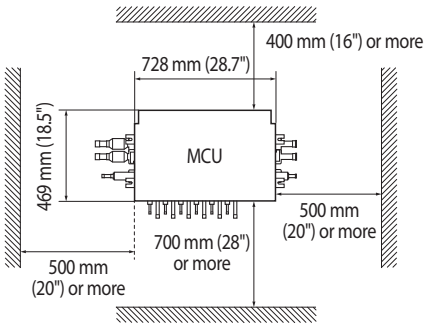

<MCU-S6NEK2N, MCU-S4NEK3N, MCU-S2NEK2N>

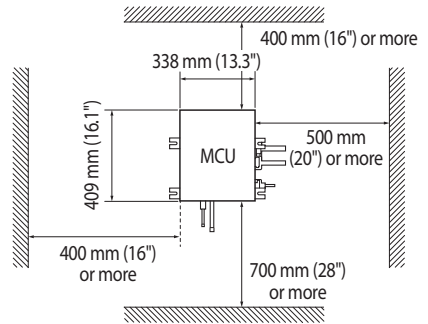

<MCU-S1NEK1N>

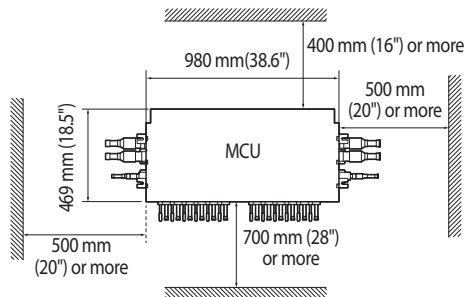



<MCU-S12NEK1N, MCU-S8NEK1N>

# Space requirements

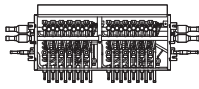
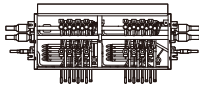
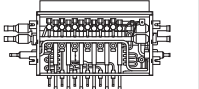
## 1. MCU specification

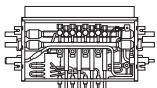
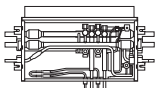
Model	MCU-S12NEK1N	MCU-S8NEK1N	MCU-S6NEK2N
Exterior of MCU			
Number of connectable indoor units at one port	Up to 8 units	Up to 8 units	Up to 8 units
Maximum number of indoor units (Total)	64	64	32
The maximum capacity of the connectable indoor units at one port	16 kW (54MBH)	16 kW (54MBH)	16 kW (54MBH)
The maximum capacity of the connectable indoor units at one port (with Y-JOINT)	32.0 kW (108 MBH)	32.0 kW (108 MBH)	32.0 kW (108 MBH)
The maximum capacity of the connectable indoor units	85.0 kW (290MBH)	85.0 kW (290MBH)	61.6 kW (216MBH)
Internal EEV	Not included Cannot connect indoor unit without internal EEV		

Model	MCU-S4NEK3N	MCU-S2NEK2N	MCU-S1NEK1N
Exterior of MCU			
Number of connectable indoor units at one port	Up to 8 units	Up to 8 units	Up to 8 units
Maximum number of indoor units (Total)	32	16	8
The maximum capacity of the connectable indoor units at one port	16 kW (54MBH)	16 kW (54MBH)	16 kW (54MBH)
The maximum capacity of the connectable indoor units at one port (with Y-JOINT)	32.0 kW (108 MBH)	32.0 kW (108 MBH)	-
The maximum capacity of the connectable indoor units	61.6 kW (216MBH)	32.0 kW (108MBH)	16 kW (54MBH)
Internal EEV	Not included Cannot connect indoor unit without internal EEV		











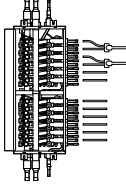
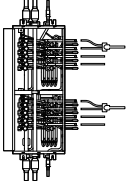
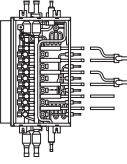
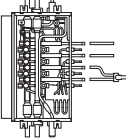
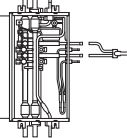
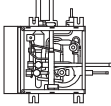
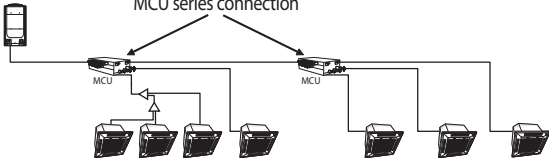



- If the sum of the connected indoor unit capacity connected to the MCU is greater than 67.2kW (228 MBH), performance may vary depending on operating conditions.
- The incoming pipe diameters supplying refrigerant to the MCU are determined based on the sum of the connected indoor units. If these pipe diameters are different than the MCU pipe diameters, use the provided reducers to connect to the MCU. If the provided reducers are not the correct size, field supplied reducers must be used.



- Si la somme de la capacité des unités intérieures connectées au MCU est supérieure à 67,2 kW (228 MBH), les performances peuvent varier en fonction des conditions de fonctionnement.
- Les diamètres des tuyaux entrants alimentant en fluide frigorigène le MCU sont déterminés en fonction de la somme des unités intérieures connectées. Si ces diamètres de tuyaux sont différents de ceux du MCU, utilisez les réducteurs fournis pour connecter le MCU. Si les réducteurs fournis ne sont pas de la taille correcte, il faut utiliser des réducteurs fournis sur place.

2. MCU specification

Model	MCU-S12NEK1N	MCU-S8NEK1N	MCU-S6NEK2N												
Example installing (Each port connection)															
															
Example installing (MCU series connection)															
Installing indoor units	<p>Indoor units under 16.0 kW (54 kBTu/h): Y-connector is not required                      Indoor units 16.0 kW ~ 32.0 kW (54 ~ 108 kBTu/h): Y-connectors at the gas and liquid lines are required                      If continuous cooling operation is required when outside temperature is below -5 °C (23°F), set outdoor option setting "Expand operational temperature range for cooling operation (HR only)", and use Y-connector on the liquid and gas pipes for indoor units 5.0 ~ 16 kW (18 ~ 54 kBTu/h).                      When MCUs are connected in series, the maximum capacity of all indoor units in MCU series connection is the larger value of MCU which are connected in series.                      Example: MCU-S12NEK1N + MCU-S6NEK2N → 85.0 kW (290MBH)</p>														
Using Y-connector	<p>[MCU-S6*, MCU-S4*, MCU-S2*, MCU-S1*]                      When twinning 2 adjacent ports, Y-connectors can only be connected to the port combinations noted below.                      Allowed Y-connector port combinations: A + B, C + D, E + F ports                      Y-connector port combinations that are NOT allowed: B + C port, D + E port, any non-continuous port (example: A+C)                      Set Dip Switch Settings when using Y-connector</p> <table border="0" data-bbox="207 1157 644 1284"> <tr> <td>S/W Option</td> <td>S/W Option</td> <td>S/W Option</td> <td>S/W Option</td> </tr> <tr> <td></td> <td></td> <td></td> <td></td> </tr> <tr> <td>Default</td> <td>Combination of A+B port</td> <td>Combination of C+D port</td> <td>Combination of E+F port</td> </tr> </table>			S/W Option	S/W Option	S/W Option	S/W Option					Default	Combination of A+B port	Combination of C+D port	Combination of E+F port
S/W Option	S/W Option	S/W Option	S/W Option												
															
Default	Combination of A+B port	Combination of C+D port	Combination of E+F port												

# Space requirements

Using Y-connector

[MCU-S12\*, MCU-S8\*]  
 When twinning 2 adjacent ports, Y-connectors can only be connected to the port combinations noted below:  
 [#1-A] + [#1-B] port, [#1-C] + [#1-D] port, [#1-E] + [#1-F] port  
 [#2-A] + [#2-B] port, [#2-C] + [#2-D] port, [#2-E] + [#2-F] port  
 Y-connector port combinations that are NOT allowed: #1 Ports: B + C port, D + E port, any non-continuous port (example: A+C)  
 #2 Ports: B + C port, D + E port, any non-continuous port (example: A+C)

Set Dip Switch Settings when using Y-connector

Dip Switch Settings when using Y-connector

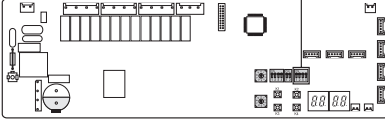

S/W Option      S/W Option      S/W Option      S/W Option

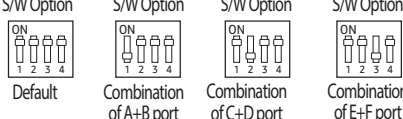

Default      Combination of A+B port      Combination of C+D port      Combination of E+F port

<Section #1>

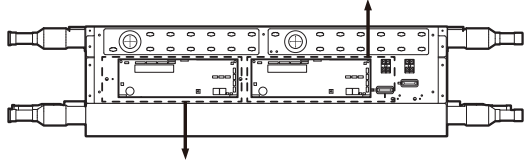

Dip Switch Settings when using Y-connector

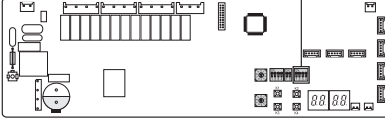

S/W Option      S/W Option      S/W Option      S/W Option

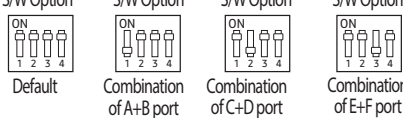

Default      Combination of A+B port      Combination of C+D port      Combination of E+F port

<Section #2>

### 3. Preparation before installation.

- 1) Place the pattern sheet on the ceiling at the spot where you want to install the indoor unit.



• Since the diagram is made of paper, it may shrink or stretch slightly due to temperature or humidity. For this reason, before drilling the holes maintain the correct dimensions between the markings.

- 2) Insert bolt anchors, use existing ceiling supports or construct a suitable support as shown in figure.
- 3) Install the suspension bolts depending on the ceiling type.



• Ensure that the ceiling is strong enough to support the weight of the unit. Before hanging the unit, test the strength of each attached suspension bolt.

• If the length of suspension bolt is more than 1.5m(4.92'), it is required to prevent vibration.

• If this is not possible, create an opening on the false ceiling in order to be able to use it to perform the required operations on the indoor unit.



• Assurez-vous que le plafond est suffisamment résistant pour supporter le poids de l'unité. Avant d'accrocher l'unité, vérifiez la résistance de chaque boulon de suspension fixé.

• Si la longueur du boulon de suspension est supérieure à 1,5 m (4,92 pi), vous devez faire le nécessaire pour éviter les vibrations.

• Si ce n'est pas possible, créez une ouverture dans le faux plafond pour pouvoir effectuer les opérations requises sur l'unité intérieure.

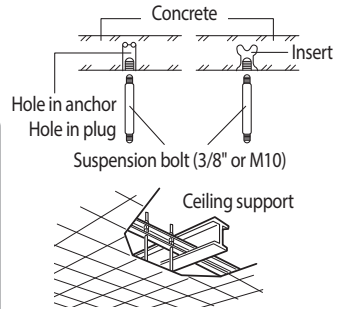
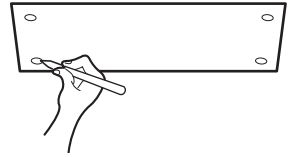

### 4. Cautions about MCU installation.

- ▶ When fixing the unit at the upper place using suspension bolts, use a nut and washer to vertically fasten the unit.
- ▶ The MCU has four suspension points to secure the MCU. All four suspension points must be used.
- ▶ Take care to ensure that the unit is installed in the correct orientation. If the MCU is installed upside down, noise will be generated and the unit may be damaged.

\*Length (Between the locations of suspension bolts)

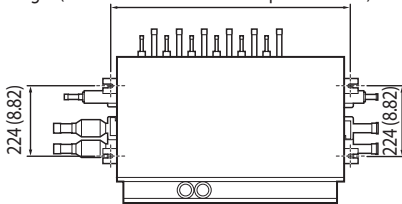

\*Length

MCU-S6*	
MCU-S4*	764(30.08)
MCU-S2*	
MCU-S1*	374(14.74)
MCU-S12*	1016(40.00)
MCU-S8*	

Unit : mm (inch)

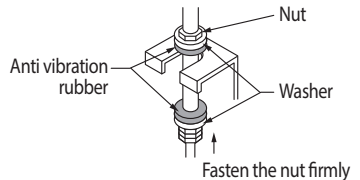

<Location and intervals of fixed suspension bolts>

<Fixing the bolt>

# Space requirements

## 5. How to connect the pipe line.

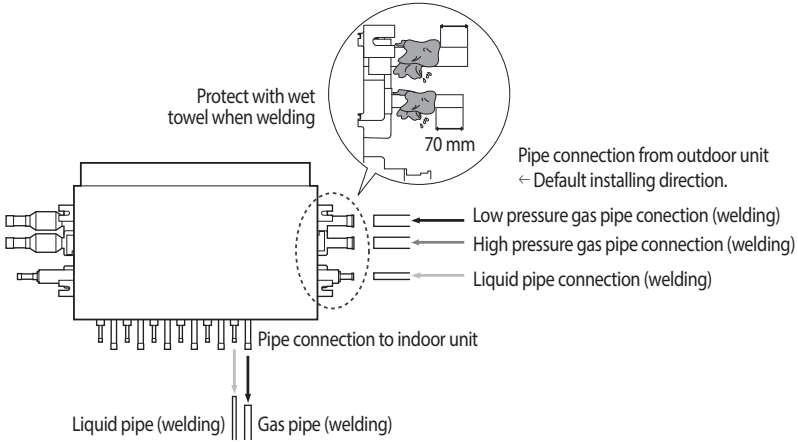

- \* When installing MCU, use the pattern sheet for installation that is provided with the product.
- \* When welding the pipes, protect the product with the flame-proof sheet.
- \* When connecting the MCU with outdoor units, default direction is set in the MCU.  
If installing opposite direction, weld the enclosed copper cap to each high pressure, low pressure and liquid pipes.

## 6. How to connect Y-connector

- ▶ In case of connecting one indoor with Y-Connector to MCU, Y-Connector must be connected in series.

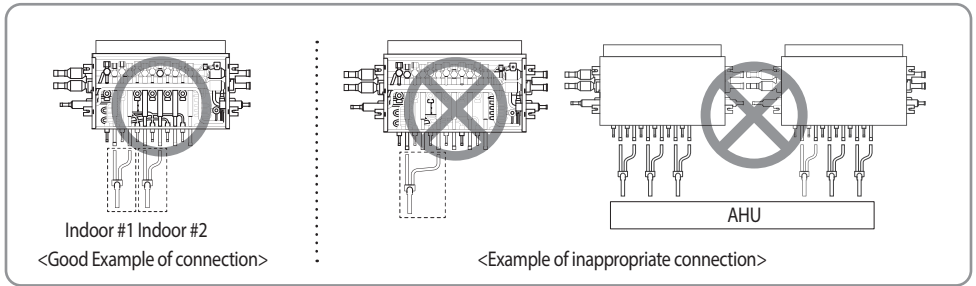



# Refrigerant piping

## Pipe brazing instructions and cautions

### Keeping refrigerant pipe clean and dry

- ▶ To prevent foreign materials or water from entering the pipe, it is important to keep the refrigerant pipe clean, dry and sealed during installation.

Exposure place	Exposure time	Sealing type
Outside exposure	Longer than one month	Pipe pinch
	Shorter than one month	Taping
Inside exposure	-	Taping

### Brazing the pipe

- ▶ Make sure that there is no moisture inside the pipe.
- ▶ Make sure that there are no foreign materials and impurities in the pipe.
- ▶ Make sure that there is no leak.
- ▶ Make sure to follow the instruction when brazing the pipe.

#### *The use of Nitrogen gas*

1. Use Nitrogen gas when brazing the pipes as shown in the picture.
2. If you don't use Nitrogen gas when brazing the pipes, oxide may form inside the pipe. It can cause the damage of the compressor and valves.
3. Adjust the flow rate of the nitrogen gas with a pressure regulator to maintain  $0.05\text{m}^3/\text{h}$  ( $1.77\text{ft}^3/\text{h}$ ) or less.

#### *Direction of the pipe when brazing*

- Performing the brazing of the pipe should be headed downwards or horizontally.

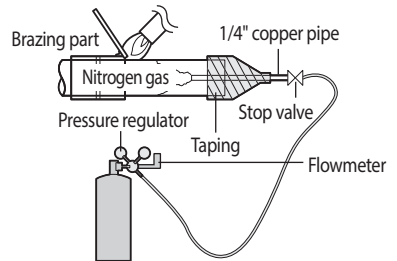

# Refrigerant piping

## Pipe insulating instructions and cautions

Make sure to check for gas leakage before completing the installation (hose and pipe insulation) and insulate hoses and pipes when there is no sign of leakage.

- To avoid condensation problems, place T13.0 (1/2") or thicker Acrylonitrile Butadien Rubber separately around each refrigerant pipe.



- When installing pipe insulation, make sure that the insulation seam is on the top of the pipes.

- Wrap insulating tape around the pipes. Avoid compressing the pipe insulation while wrapping.
- Finish wrapping insulating tape around the rest of the pipes leading to the outdoor unit.
- Pipes and electrical cables connecting the unit with the outdoor unit must be secured to the structure with appropriate straps/hangers.



- All refrigerant connection must be accessible, in order to permit either unit maintenance or removing it completely.



- Tous les raccords des tuyaux de réfrigérant doivent être accessibles afin de permettre l'entretien de l'appareil ou son retrait complet.

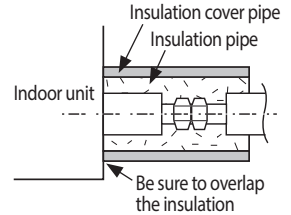
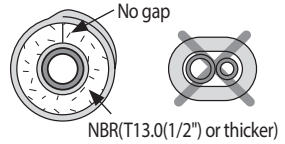

- Must fit tightly against body without any gap.



- L'ajustement doit être effectué fermement contre le corps, sans aucun espace.

- Select the insulation of the refrigerant pipe.

- Insulate the gas side and liquid side pipe referring to the thickness according to the pipe size.
- Indoor temperature of 30°C(86°F) and humidity of 85% is the standard condition. If install in a high humidity condition, use one grade thicker insulator by referring to the table below. If installing in an unfavorable conditions,use thicker one.
- Insulator's heat-resistance temperature should be more than 120°C(248°F).

Pipe	Outer diameter		Insulator (Cooling, Heating)				Remarks
			General [30°C (86°F), 85%]		High humidity [30°C (86°F), over 85%]		
			EPDM, NBR				
mm	inch	mm	inch	mm	inch		
Liquid pipe	6.35~9.52	1/4~3/8	9	3/8	9	3/8	Heating resisting temperature over 120°C (248°F)
	12.70~50.80	1/2~2	13	1/2	13	1/2	
Gas Pipe	6.35	1/4	13	1/2	19	3/4	
	9.52~25.4	3/8~1	19	3/4	25	1	
	28.58~44.45	1 1/8~1 3/4	19	3/4	32	1 1/4	
	50.80	2	25	1	38	1 1/2	

*Refrigerant pipe before EEV kit and MCU or without EEV kit and MCU*

- ▶ You can contact the gas side and liquid side pipes but the pipes should not be pressed.
- ▶ When contacting the gas side and gas side pipe, use 1 grade thicker insulator.

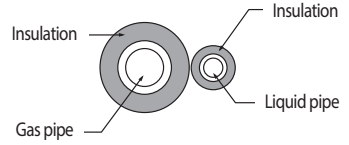

*Refrigerant pipe after EEV kit and MCU*

- ▶ Install the gas side and liquid side pipes, leave 10mm(3/8") of space.
- ▶ When contacting the gas side and liquid side pipe, use 1 grade thicker insulation.

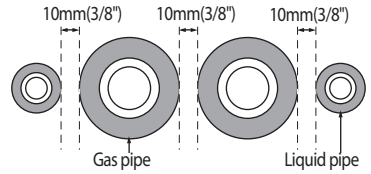

*Insulation for non-serial connection of MCU*

- ▶ Exposed pipes should be insulated.

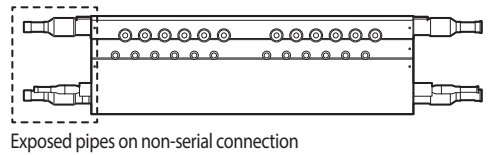

- Prevent insulation thickness from getting thinner at the pipe hanger. Use adhesives on the seams to prevent moisture from entering.
- Wrap the refrigerant pipe with insulation tape if it is exposed to outside sunlight.
- Install the refrigerant pipe ensuring that the insulation does not get thinner on the bent part or hanger of pipe.
- Add the additional insulation if the insulation plate gets thinner.

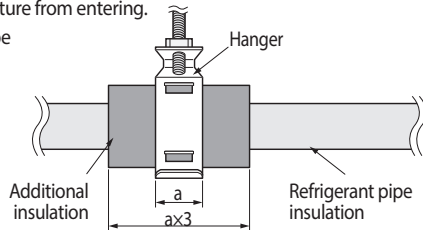

- Empêchez l'épaisseur de l'isolant de diminuer au niveau de la fixation du tube. Utilisez des adhésifs sur les coutures pour empêcher l'humidité de pénétrer.
- Entourez le tube réfrigérant avec du ruban isolant s'il est exposé à la lumière extérieure.
- Installez le tube réfrigérant de façon à ce que l'isolant ne soit pas plus mince sur la partie coudée ou la fixation du tube.
- Ajoutez du matériau isolant si la plaque d'isolation devient plus fine.

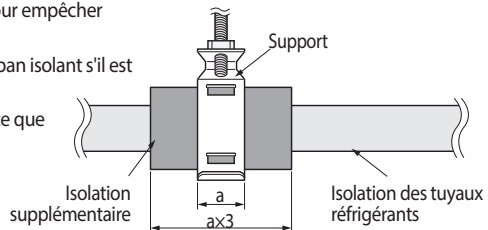

# Wiring

## Installing the circuit breaker and wires

Power supply	MCCB	ELB	Power cable	Earth cable	Communication cable
Max: 242V Min: 198V	x [A]	x [A], 30mmA 0.1 sec	0.0039inch <sup>2</sup> (2.5mm <sup>2</sup> )	0.0039inch <sup>2</sup> (2.5mm <sup>2</sup> )	0.0012~0.0023inch <sup>2</sup> (0.75~1.5mm <sup>2</sup> )

\*  $x [A] \geq 1.25 \times 1.1 \times \sum A_i$

(x [A] : MCCB/ELB amperes,  $\sum A_i$  : Sum of the rated current amperes of indoors)

## Installing the wire

- ▶ Supply the 220-240V/208-230V power to L1, L2 (L, N) of MCU separately
- ▶ Connect the communication cable from the outdoor unit to F1, F2 of MCU.
- ▶ Power Line and communication line must be connected as shown in drawing.

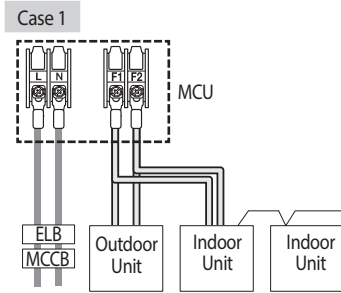

220-240V/208-230V / Single Phase  
(Supply separately)

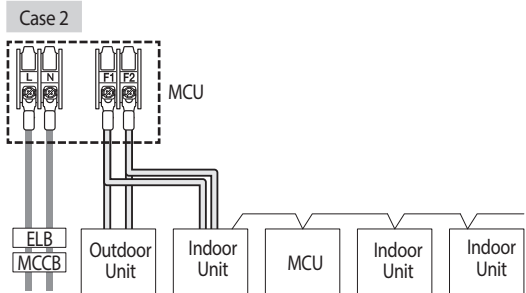

220-240V/208-230V / Single Phase  
(Supply separately)

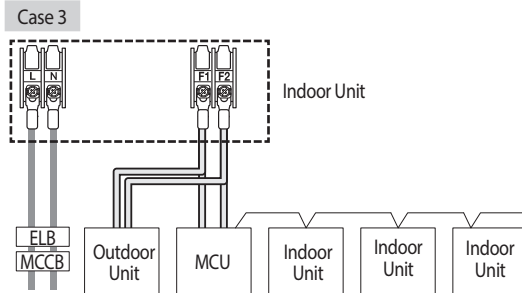

220-240V/208-230V / Single Phase  
(Supply separately)

► Power line and communication line must be installed as shown in drawing

\* Hole size is  $\Phi$  43.7 mm (1.72 inches)

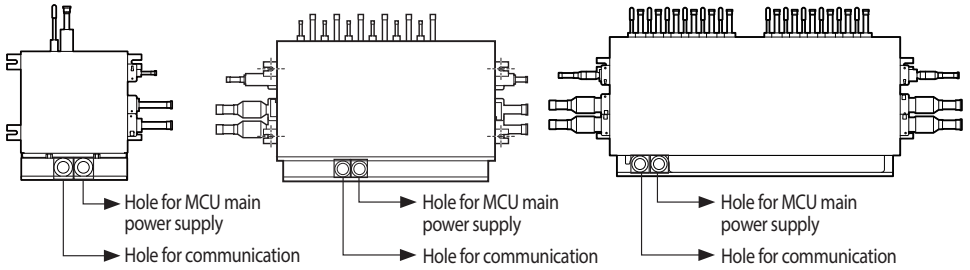



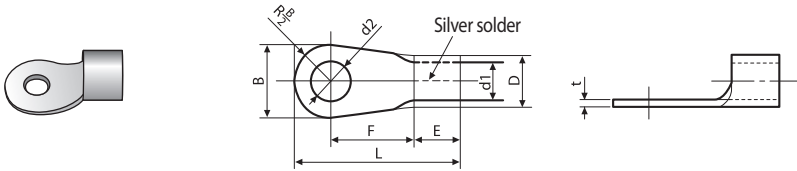



► Choose the compressed socket based on the cross-section of the connecting wire.



Nominal dimensions for cable [mm <sup>2</sup> (inch <sup>2</sup> )]		1.5 (0.002)		2.5 (0.003)		4 (0.006)	
Nominal dimensions for screw [mm (inch)]		4 (0.157)		4 (0.157)		4 (0.157)	
B	Standard dimension [mm (inch)]	6.6 (0.259)		8 (0.314)		6.6 (0.259)	
	Allowance [mm (inch)]	±0.2 (0.007)		±0.2 (0.007)		±0.2 (0.007)	
D	Standard dimension [mm (inch)]	3.4 (0.134)		4.2 (0.165)		5.6 (0.220)	
	Allowance [mm (inch)]	+0.3 (0.011) -0.2 (-0.007)		+0.3 (0.011) -0.2 (-0.007)		+0.3 (0.011) -0.2 (-0.007)	
d1	Standard dimension [mm (inch)]	1.7 (0.066)		2.3 (0.090)		3.4 (0.133)	
	Allowance [mm (inch)]	+0.2 (±0.007) 0		+0.2 (±0.007) 0		+0.2 (±0.007) 0	
E	Min. [mm (inch)]	4.1 (0.161)		6 (0.236)		6 (0.236)	
F	Min. [mm (inch)]	6 (0.236)		6 (0.236)		5 (0.196)	
L	Max. [mm (inch)]	16 (0.629)		17.5 (0.6888)		20 (0.787)	
d2	Standard dimension [mm (inch)]	4.3 (0.169)		4.3 (0.169)		4.3 (0.169)	
	Allowance [mm (inch)]	+0.2 (±0.007) 0		+0.2 (±0.007) 0		+0.2 (±0.007) 0	
t	Min. [mm (inch)]	0.7 (0.027)		0.8 (0.031)		0.9 (0.035)	

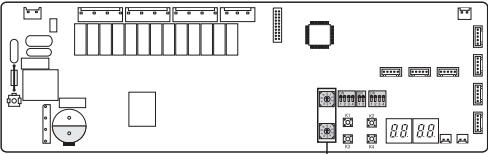
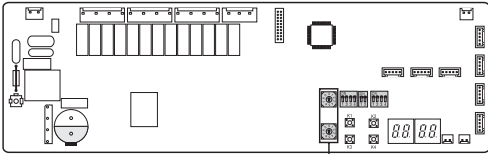

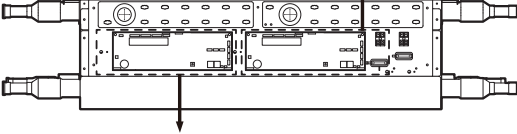
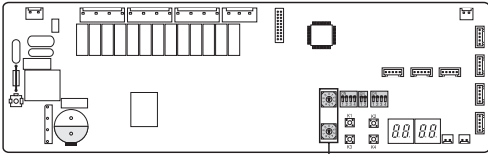



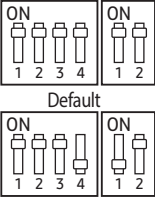
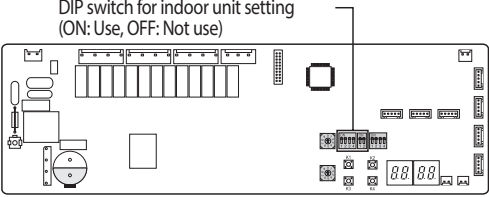
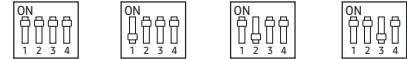



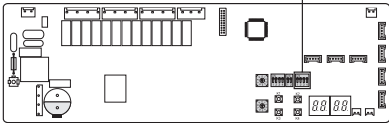



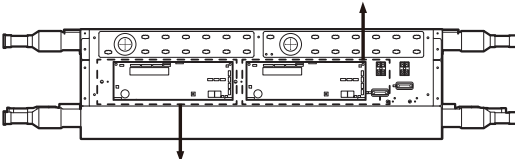
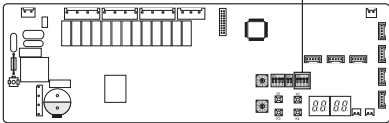









## Setting MCU address and port

- \* When counting the quantity of MCUs while outdoor unit installation, one MCU is one.  
However, in the case of MCU-S12NEK1N and MCU-S8NEK1N, one MCU must be counted as two MCUs.

Process	
<p>1. MCU address setting</p>	<p>Set MCU address by rotary switch.</p> <p>Example&gt; If you want to set MCU address to 12, set upper rotary switch to 1 and set bottom rotary switch to 2</p> <div style="display: flex; justify-content: space-around; align-items: flex-start;"> <div style="text-align: center;"> <p>MCU Address</p>  <p>Default</p> </div> <div style="text-align: center;"> <p>MCU Address</p>  <p>Setting MCU address to 12</p> </div> <div style="text-align: center;">  <p>Rotary switch for MCU ADDRESS</p> </div> </div>
	<p>* MCU-S12NEK1N &amp; MCU-S8NEK1N models have two PBAs in the control box. The MCU addresses of the two PBAs must be set differently.</p> <p>Example&gt; If you set MCU address of the section #1 PBA to 11, then set the section #2 PBA address to 12.</p> <div style="display: flex; justify-content: space-around; align-items: flex-start;"> <div style="text-align: center;">  <p>Rotary switch for MCU ADDRESS</p> <p>&lt;Section #1&gt;</p> </div> <div style="text-align: center;"> <p>MCU Address</p>  <p>Setting MCU address to 11</p> </div> </div> <div style="display: flex; justify-content: center; align-items: center; margin: 10px 0;">  </div> <div style="display: flex; justify-content: space-around; align-items: flex-start;"> <div style="text-align: center;">  <p>Rotary switch for MCU ADDRESS</p> <p>&lt;Section #2&gt;</p> </div> <div style="text-align: center;"> <p>MCU Address</p>  <p>Setting MCU address to 12</p> </div> </div>

Process	
<p>2. <b>DIP switch setting for using each port</b></p>	<p>Set using each port (connected to indoor unit) by DIP switch            Example&gt; If you want to connect indoor units at A,B,C,F port, set DIP switch 1,2,3,2 to 'ON'</p> <p>DIP S/W</p>  <p>Using A, B, C, F port</p> 
<p>3. <b>DIP switch setting for using Y-connector</b></p>	<p>[MCU-S6*, MCU-S4*, MCU-S2*, MCU-S1*]            When twinning 2 adjacent ports, Y-connectors can only be connected to the port combinations noted below.            Allowed Y-connector port combinations: A + B, C + D, E + F ports            Y-connector port combinations that are NOT allowed: B + C port, D + E port, any non-continuous port (example: A+C)            Set Dip Switch Settings when using Y-connector</p> <p>S/W Option    S/W Option    S/W Option    S/W Option</p>  <p>Default    Combination of A+B port    Combination of C+D port    Combination of E+F port</p>

# Wiring

Process									
<p><b>3. DIP switch setting for using Y-connector</b></p>	<p>[MCU-S12*, MCU-S8*]</p> <p>When twinning 2 adjacent ports, Y-connectors can only be connected to the port combinations noted below:            [#1-A] + [#1-B] port, [#1-C] + [#1-D] port, [#1-E] + [#1-F] port            [#2-A] + [#2-B] port, [#2-C] + [#2-D] port, [#2-E] + [#2-F] port</p> <p>Y-connector port combinations that are NOT allowed: #1 Ports: B + C port, D + E port, any non-continuous port (example: A+C)            #2 Ports: B + C port, D + E port, any non-continuous port (example: A+C)</p> <p>Set Dip Switch Settings when using Y-connector</p> <div style="display: flex; align-items: center; justify-content: center;"> <div style="text-align: center;"> <p>Dip Switch Settings when using Y-connector</p>  </div> <div style="margin-left: 20px;"> <table border="0"> <tr> <td style="text-align: center;">S/W Option ON  Default</td> <td style="text-align: center;">S/W Option ON  Combination of A+B port</td> <td style="text-align: center;">S/W Option ON  Combination of C+D port</td> <td style="text-align: center;">S/W Option ON  Combination of E+F port</td> </tr> </table> </div> </div> <p style="text-align: center;">&lt;Section #1&gt;</p> <div style="text-align: center; margin: 20px 0;">  </div> <div style="display: flex; align-items: center; justify-content: center;"> <div style="text-align: center;"> <p>Dip Switch Settings when using Y-connector</p>  </div> <div style="margin-left: 20px;"> <table border="0"> <tr> <td style="text-align: center;">S/W Option ON  Default</td> <td style="text-align: center;">S/W Option ON  Combination of A+B port</td> <td style="text-align: center;">S/W Option ON  Combination of C+D port</td> <td style="text-align: center;">S/W Option ON  Combination of E+F port</td> </tr> </table> </div> </div> <p style="text-align: center;">&lt;Section #2&gt;</p>	S/W Option ON  Default	S/W Option ON  Combination of A+B port	S/W Option ON  Combination of C+D port	S/W Option ON  Combination of E+F port	S/W Option ON  Default	S/W Option ON  Combination of A+B port	S/W Option ON  Combination of C+D port	S/W Option ON  Combination of E+F port
S/W Option ON  Default	S/W Option ON  Combination of A+B port	S/W Option ON  Combination of C+D port	S/W Option ON  Combination of E+F port						
S/W Option ON  Default	S/W Option ON  Combination of A+B port	S/W Option ON  Combination of C+D port	S/W Option ON  Combination of E+F port						



Process													
4. MCU address and port setting for indoor unit (for wireless remote controller)	Auto setting: refer to 'auto pipe pairing' in outdoor installation manual.												
	Manual setting :												
	1. Wireless remote controller												
	1) Enter mode to set option												
	2) Assign an indoor unit MCU port address by wireless remote controller												
	- The initial setting status of indoor unit ADDRESS(MAIN/RMC/MCU port) is "0A0000-100000-200000-300000"												
	Option	SEG1		SEG2		SEG3		SEG4		SEG5		SEG6	
	Explanation	PAGE		Mode		Setting Main address		100-digit of indoor unit address		10-digit of indoor unit		The unit digit of an indoor unit	
	Remote Controller Display												
	Indication and Details	Indication	Details	Indication	Details	Indication	Details	Indication	Details	Indication	Details	Indication	Details
0			A	Address setting mode	0	No Main address							
					1	Main address setting mode	0~9	100-digit	0~9	10-digit	0~9	A unit digit	
Option	SEG7		SEG8		SEG9		SEG10		SEG11		SEG12		
Explanation	PAGE				Setting RMC address				Group channel(*16)		Group address		
Remote Controller Display													
Indication and Details	Indication	Details	-		Indication	Details	-		Indication	Details	Indication	Details	
	1				0	No RMC address							
					1	RMC address setting mode			RMC1	0~F	RMC2	0~F	
Option	SEG13		SEG14		SEG15		SEG16		SEG17		SEG18		
Explanation	PAGE				Setting MCU PORT address		10-digit of MCU		The unit digit of MCU		PORT address		
Remote Controller Display													
Indication and Details	Indication	Details	-		Indication	Details	Indication	Details	Indication	Details	Indication	Details	
					0	No MCU port address							
					1	MCU port address setting mode	0~1	10-digit	0~9	A unit digit	A~F	PORT Location	
Example> If you want to set the indoor unit to 'A' port of MCU #1. 0A0000 – 100000 – 20101A -30000													

# Wiring

**4. MCU address and port setting for indoor unit (for wired remote controller)**

2. Wired remote controller

- Setting for MWR-WE1\*N
  - 1) Press the Delete and Set buttons at the same time for more than three seconds. Then you will enter the additional function settings, and the [main menu] will be displayed.
  - 2) Assign an indoor unit MCU port address with main menu 4, sub menu 7 (MCU address is assigned to SEG 12, Port address is assigned to SEG 4). If you want to know the detailed operation of MWR-WE1\*N, refer to installation manual for MWR-WE1\*N.

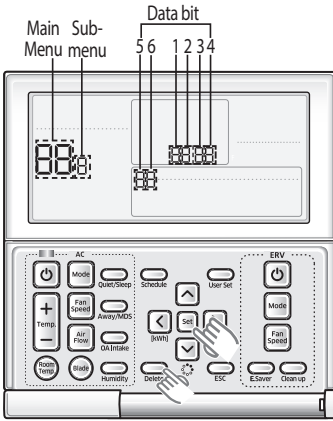





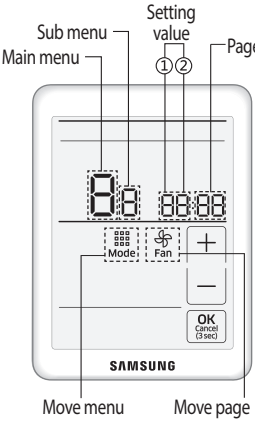

Main menu	Sub menu	Function	Setting value	
			Description	Factory default
4	1	Setting/Checking the address	MAIN address (00H~4FH)	None
	2	Setting/Checking the product option	MAIN address (00H~4FH)	None
	3	Indoor unit/Ventilator(ERV) option setting	Refer to the installation manual of the connected indoor unit/ventilator (ERV)	None
	4		Setting/Checking the installation option 2	None
	7	MCU address setting/ checking Port address setting/ checking	MCU address (00~15) Port address (A~F)	None

- Setting for MWR-SH1\*N
  - 1) Press the top right corner (hidden button) of the display for more than 3 seconds then release it. Then you can press [ + ]/[ - ] buttons and select No.3 and press [ OK ] button.
  - 2) Assign an indoor unit MCU port address with main menu 4, sub menu 7 (MCU address is assigned to SEG 12, Port address is assigned to SEG 4). If you want to know the detailed operation of MWR-SH1\*N, refer to installation manual for MWR-SH1\*N.

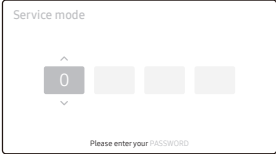

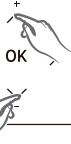
Main menu	Sub menu	Function	Setting value		
			value	Factory default	
4	1	Target address setting	Target address of indoor unit (Example: 20 02 1F)	None	
	2	Main address setting/Checking	0~4F (in hexadecimal digits)		
	3	RMC address setting/Checking	0x00~0xFE	None	
	4	Setting address/option	Basic option setting/Checking		Option code
	5		Install option setting/Checking		Option code
	6	Install(2) option setting/Checking	Option code	None	
	7	MCU address setting/checking Port address setting/checking	MCU address (00~15) Port address (A~F)	None	

Process													
<b>4. MCU address and port setting for indoor unit (for wired remote controller)</b>	<p>– Setting for MWR-WG0**</p> <ol style="list-style-type: none"> <li>1) Press the  and  buttons at the same time for more than 3 seconds. Then you can enter the password(0202) and press the OK button.</li> <li>2) Assign an indoor unit MCU port address with [Major] General → [Step1] Indoor unit/Ventilator option → [Step2] MCU port → [Step3] MCU address &amp; MCU port.</li> </ol> <p>* For more information, please refer to the installation manual of MWR-WG0**</p> <table border="1" data-bbox="288 363 1031 440"> <thead> <tr> <th>Major</th> <th>Step1</th> <th>Step2</th> <th>Step3</th> <th>Description</th> </tr> </thead> <tbody> <tr> <td rowspan="2">General</td> <td rowspan="2">Indoor unit/ Ventilator option</td> <td rowspan="2">MCU port</td> <td>MCU address</td> <td>00 to 15</td> </tr> <tr> <td>MCU port</td> <td>A to F</td> </tr> </tbody> </table> <div data-bbox="288 459 631 807" style="border: 1px solid black; padding: 10px; margin: 10px 0;"> <p style="text-align: center;">Service mode</p> <div style="text-align: center;">  </div> <div style="display: flex; justify-content: space-around; align-items: center; margin-top: 10px;">      </div> </div> <ol style="list-style-type: none"> <li>3. Setting by using S-NET Pro 2 Set the pipe addresses by using Add-on &gt; Change address on S-NET Pro 2. (For more information, see the S-NET Pro 2 Help.)</li> </ol>	Major	Step1	Step2	Step3	Description	General	Indoor unit/ Ventilator option	MCU port	MCU address	00 to 15	MCU port	A to F
Major	Step1	Step2	Step3	Description									
General	Indoor unit/ Ventilator option	MCU port	MCU address	00 to 15									
			MCU port	A to F									

# Wiring



- The Direct-connected indoor unit without MCU like below picture, be sure to set their options to "Cooling only unit setting" and then connect them to a low pressure gas pipe and a liquid pipe. This indoor unit only operate to cooling mode.
- If two or more indoor units are connected to a single port, switching between cooling and heating mode does not work while in auto mode. It is recommended to select the cooling or heating mode.

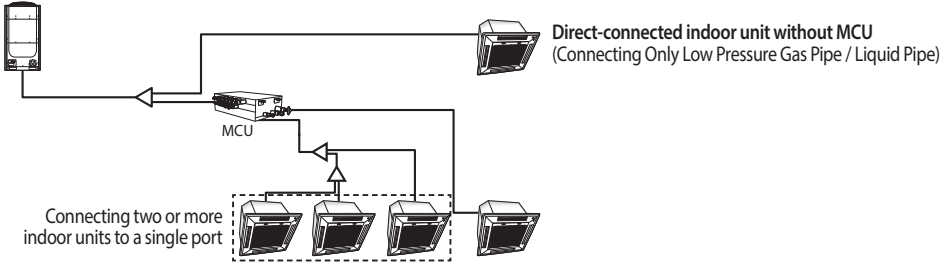

## Set to Cooling Only Unit

1. Check whether power is supplied or not.
  - When the indoor unit is not plugged in, there should be additional power supply in the indoor unit.
2. The panel(display) should be connected to an indoor unit to receive option.
3. Enter mode to set option (\* Detail method of entering option mode refer to indoor unit installation manual)
4. Set the 05 series installation option at SEG3 to '2' like this '052000 - 100000 - 20000 - 30000'.  
(The default setting of an indoor unit 05 series installation is '050000 - 100000 - 20000 - 30000')





- When setting the "Cooling only unit" option, be sure to set the SEG 9 (Hot water heater) of 02 Series installation to "0".
- When "Cooling only unit" option is set, heating operation is not performed when the controller (wireless remote controller, central controller) is set to the heating mode.



- En cas de réglage de l'unité sur le mode refroidissement exclusif, veuillez à régler le SEG 9 (chauffe-eau) de la série 02 sur 0 lors de l'installation.
- Lorsque l'option de refroidissement uniquement est sélectionnée pour l'unité, aucun fonctionnement en mode chauffage n'est possible lorsque le contrôleur (de la télécommande sans fil ou central) est réglé sur le mode chauffage.

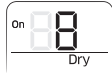

## Option No. : 05XXXX-1XXXXX-2XXXXX-3XXXXX



Option	SEG1	SEG2	SEG3	SEG4	SEG5	SEG6				
Explanation	PAGE	MODE	Use of Auto Change Over for HR only in Auto mode / Cooling only unit setting	(When setting SEG3) Standard heating temp. Offset	(When setting SEG3) Standard cooling temp. Offset	(When setting SEG3) Standard for mode change Heating → Cooling				
Remote Controller Display										
Indication and Details	0	5	0	Follow product option	0	0	0	0	0	1
			1	Use Auto Change Over for HR only	1	0.5	1	0.5	1	1.5
					2	1	2	1	2	2
					3	1.5	3	1.5	3	2.5
			2	Cooling only unit setting	4	2	4	2	4	3
					5	2.5	5	2.5	5	3.5
					6	3	6	3	6	4
			7	3.5	7	3.5	7	4.5		

Option	SEG7		SEG8		SEG9		SEG10	
Explanation	PAGE		(When setting SEG3) Standard for mode changing Cooling → Heating mode		(When setting SEG3) Time required for mode change		Compensation option for Long pipe or height difference between indoor units	
Remote Controller Display								
Indication and Details	Indication	Details	Indication	Details	Indication	Details	Indication	Details
	1		0	1	0	5 min.	0	Use default value
		1	1.5	1	7 min.	1	1) Height difference <sup>1)</sup> is more than 30m or 2) Distance <sup>2)</sup> is longer than 110m	
		2	2	2	9 min.			
		3	2.5	3	11 min.			
		4	3	4	13 min.			
		5	3.5	5	15 min.			
		6	4	6	20 min.			
7	4.5	7	30 min.	2	1) Height difference <sup>1)</sup> is 15~30m or 2) Distance <sup>2)</sup> is 50~110m			

### Key operation

※ MCU-S12NEK1N & MCU-S8NEK1N models have two PBA in the control box.  
There are two sections in the MCU. So, key operation must be set differently for each section.

Display MCU status   Display indoor unit's address

  Solenoid valve manual control

K1 (Pushed time)	Display Contents	Display segment				Remarks
		1	2	3	4	
1	MCU address	0	Blank	0	0	MCU address 0
			Blank	0	1	MCU address 1
			Blank	0	2	MCU address 2
			Blank	1	1	MCU address 11
			Blank	1	5	MCU address 15
2	Mode switching EEV1 step	1	4	8	0	Ex) 480 steps
3	Mode switching EEV2 step	2	4	8	0	Ex) 480 steps
4	Mode switching EEV3 step	3	4	8	0	Ex) 480 steps
5	Mode switching EEV4 step	4	4	8	0	Ex) 480 steps
6	Mode switching EEV5 step	5	4	8	0	Ex) 480 steps
7	Mode switching EEV6 step	6	4	8	0	Ex) 480 steps
8	Subcooler EEV step	7	4	8	0	Ex) 480 steps
9	Subcooler-in sensor temperature	8	-	0	1	Ex) -1°C
			Blank	1	0	Ex) 10°C
10	Subcooler-out sensor temperature	9	-	0	1	Ex) -1°C
			Blank	1	0	Ex) 10°C
11	On/Off for solenoid valve A_C, A_H	A	-	<ul style="list-style-type: none"> <li>*_C: Cooling solenoid valve of port *</li> <li>*_H: Heating solenoid valve of port *</li> <li>• 3rd segment: Cooling solenoid valve On: 1 / Off: 0</li> <li>• 4th segment: Heating solenoid valve On: 1 / Off: 0</li> </ul>		
12	On/Off for solenoid valve B_C, B_H	B				
13	On/Off for solenoid valve C_C, C_H	C				
14	On/Off for solenoid valve D_C, D_H	D				
15	On/Off for solenoid valve E_C, E_H	E				
16	On/Off for solenoid valve F_C, F_H	F				
17	On/Off for liquid by pass solenoid valve	G				
			o	F	F	Ex) Off
18	Version	8	A	2	0	Ex) October 20, 2008 → 8A 20
19	End of K1 display					

# Wiring

K2 (Pushed time)	Display Contents	Display segment				Remarks
		1	2	3	4	
1	Indoor unit main address for matching with port A	A	-	0	0	Indoor unit main address of port A : 0
2	Indoor unit main address for matching with port B	B	-	0	3	Indoor unit main address of port B : 3
3	Indoor unit main address for matching with port C	C	-	0	6	Indoor unit main address of port C : 6
4	Indoor unit main address for matching with port D	D	-	0	9	Indoor unit main address of port D : 9
5	Indoor unit main address for matching with port E	E	-	1	1	Indoor unit main address of port E : 11
6	Indoor unit main address for matching with port F	F	-	1	5	Indoor unit main address of port F : 15
7	End of K2 display					

※ When two or more indoor units are connected to one port, Indoor unit addresses are sequentially displayed at 2-second intervals from the lowest address indoor unit. (After displaying all, display the first indoor unit again)

## K4 Switch (Solenoid Valve Manual Control)

- ▶ According to the push time of K4 Switch, A\_C, A\_H, ..., F\_C, F\_H, Liquid bypass solenoid valve opens in order.
- ▶ In Solenoid Valve Manual Control mode, valve operates by K4 Push time irrespective of indoor operation mode.
- ▶ In Solenoid Valve Manual Control mode, push K1 Switch makes DATA DISPLAY MODE to start and valves will operate following indoor operation mode.

K4 (Push time)	Display Contents	Display segment			
		1	2	3	4
1	A_C sol valve ON, other sol valve Off	P	A	1	0
2	A_H sol valve ON, other sol valve Off	P	A	0	1
3	B_C sol valve ON, other sol valve Off	P	B	1	0
4	B_H sol valve ON, other sol valve Off	P	B	0	1
5	C_C sol valve ON, other sol valve Off	P	C	1	0
6	C_H sol valve ON, other sol valve Off	P	C	0	1
7	D_C sol valve ON, other sol valve Off	P	D	1	0
8	D_H sol valve ON, other sol valve Off	P	D	0	1
9	E_C sol valve ON, other sol valve Off	P	E	1	0
10	E_H sol valve ON, other sol valve Off	P	E	0	1
11	F_C sol valve ON, other sol valve Off	P	F	1	0
12	F_H sol valve ON, other sol valve Off	P	F	0	1
13	Liquid b/p sol valve ON, other sol valve Off	P	S	1	0
14	sol valve Manual Control MODE end	P	Communication DATA Display		

# MCU Installation Checklist

Item	Check
1. If the gas leaking test has been completed or not.	
2. If MCU has been fixed securely enough to avoid the danger of vibration and falling or not.	
3. The Insulation condition of the pipe. (Refrigerant pipe, Pipe connection.)	
4. If the R-410A refrigerant has been charged or not. If the subsidiary unit for R-410A has been used or not.	
5. Checking malfunction of the wire and the communication line.	
6. If the MCU frame has been installed upside-down or not.	
7. If the wire earthing work has been done or not.	
8. If the space between sidewalls, ceiling concrete, and the ceiling Tex has been secured enough or not to install the MCU frame.	
9. If the supporting tool of the MCU pipe has been safely placed in 1.5m intervals or not.	
10. If the prescribed wire has been used or not.	
11. If the supplied power is proper or not.	
12. If the additional refrigerant is proper or not. (Refer to the installation manual of the HR outdoor unit.)	

# SAMSUNG

This product is India RoHS compliant

