

# Outdoor Units

---

1. Summary Table	273
2. Dimensional Drawing	274
3. Center of Gravity	279
4. Electrical Wiring Diagram	282
5. Sound Data	286
6. Capacity Correction	290
7. Operation Range	294
8. Piping Diagram	295

# 1. Summary Table

## Outdoor Units

### Performance Characteristics

Capacity kW	Model Code	Net Size (WxHxD mm)	Net Weight (kg)	Airflow (CMM)	Sound Pressure Level (dBA)		Sound Power Level (dBA)
					Cooling	Heating	
2.6	AC026RXADKG/EU	790 x 548 x 285	32.5	29	46	47	59
3.5	AC035RXADKG/EU	790 x 548 x 285	32.5	30	48	48	61
5.2	AC052RXADKG/EU	880 x 638 x 310	43.0	40	48	48	62
7.1	AC071RXADKG/EU	880 x 798 x 310	51.0	51	49	51	65
10.0	AC100RXAD*G/EU	940 x 998 x 330	72.0	72	52	54	69
12.0	AC120RXAD*G/EU	940 x 998 x 330	77.0	72	54	56	70
13.4	AC140RXAD*G/EU	940 x 1,210 x 330	87.0	110	53	54	69

### NOTE

- Sound power level is based on cooling operation.

# 2. Dimensional Drawing

## Outdoor Units

AC026/035RXADKG/EU

Units : mm [inches]

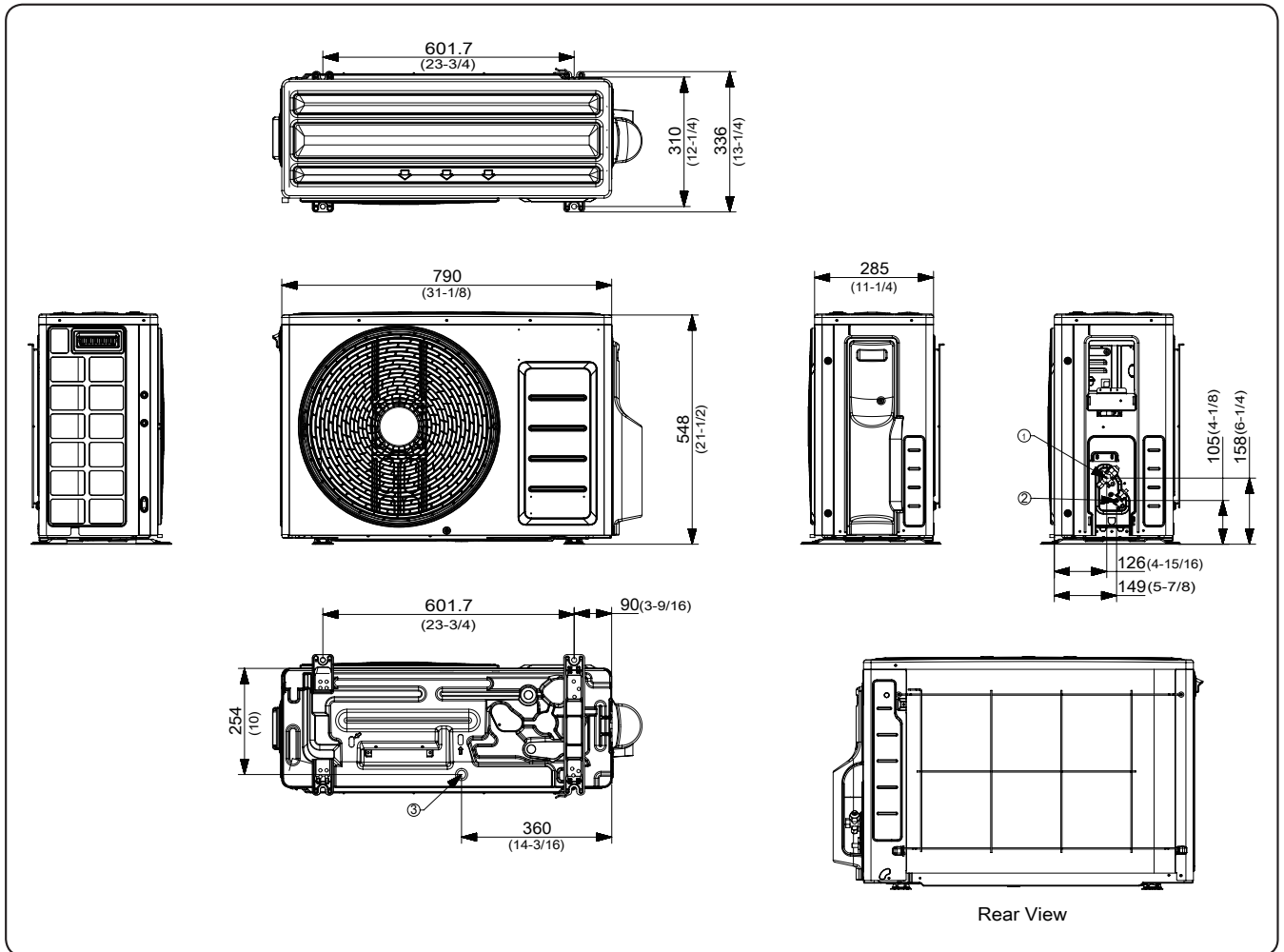

No.	Name	Description
1	Refrigerant gas pipe	Φ9.52(3/8)
2	Refrigerant liquid pipe	Φ6.35(1/4)
3	Drain Hole	Connection with the provided drain plug.

# 2. Dimensional Drawing

## Outdoor Units

AC052RXADKG/EU

Units : mm [inches]

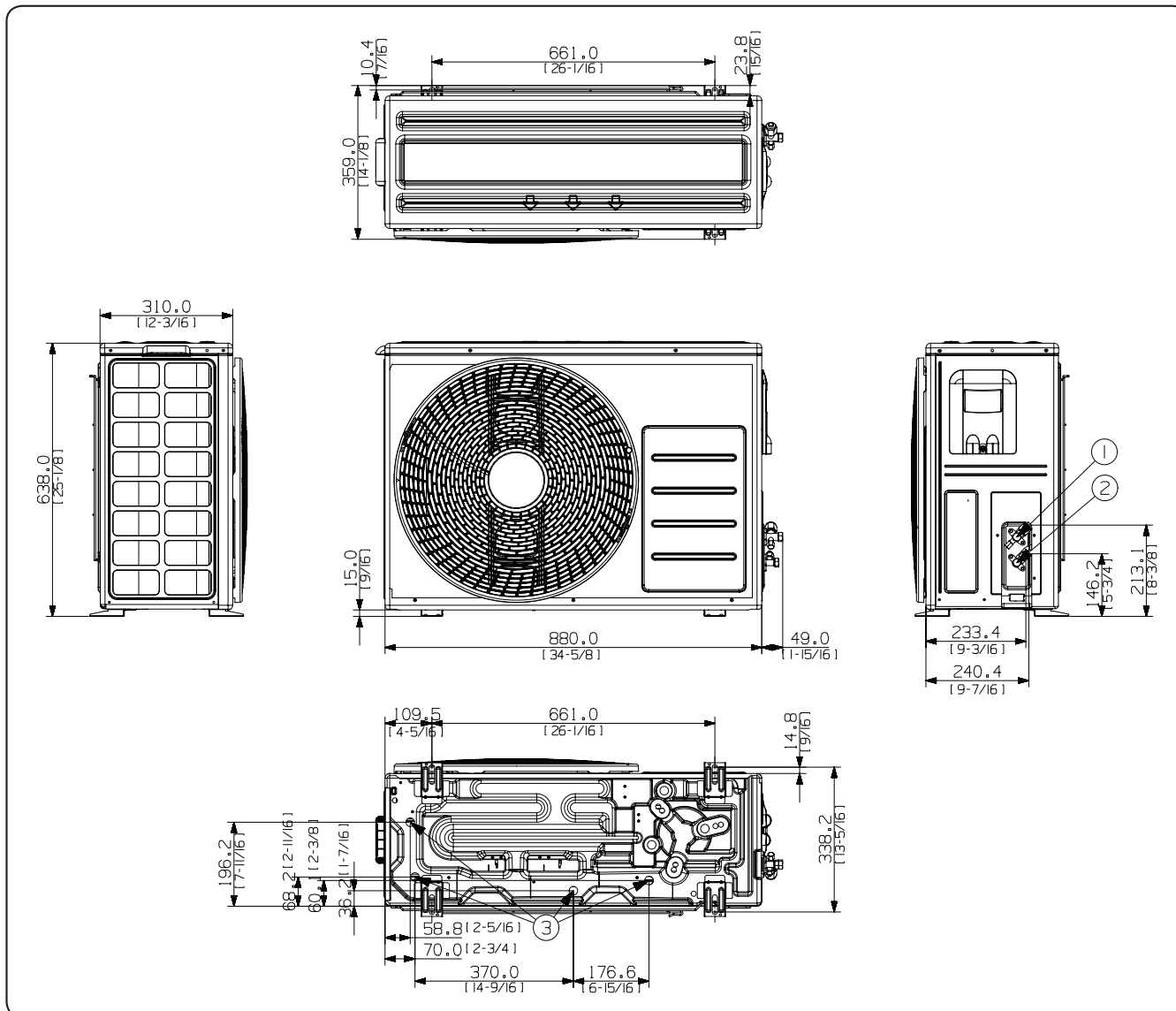

No.	Name	Description
1	Refrigerant gas pipe	Φ12.7(1/2)
2	Refrigerant liquid pipe	Φ6.35(1/4)
3	Drain Hole	Φ20

# 2. Dimensional Drawing

## Outdoor Units

### AC071RXADKG/EU

Units : mm [inches]

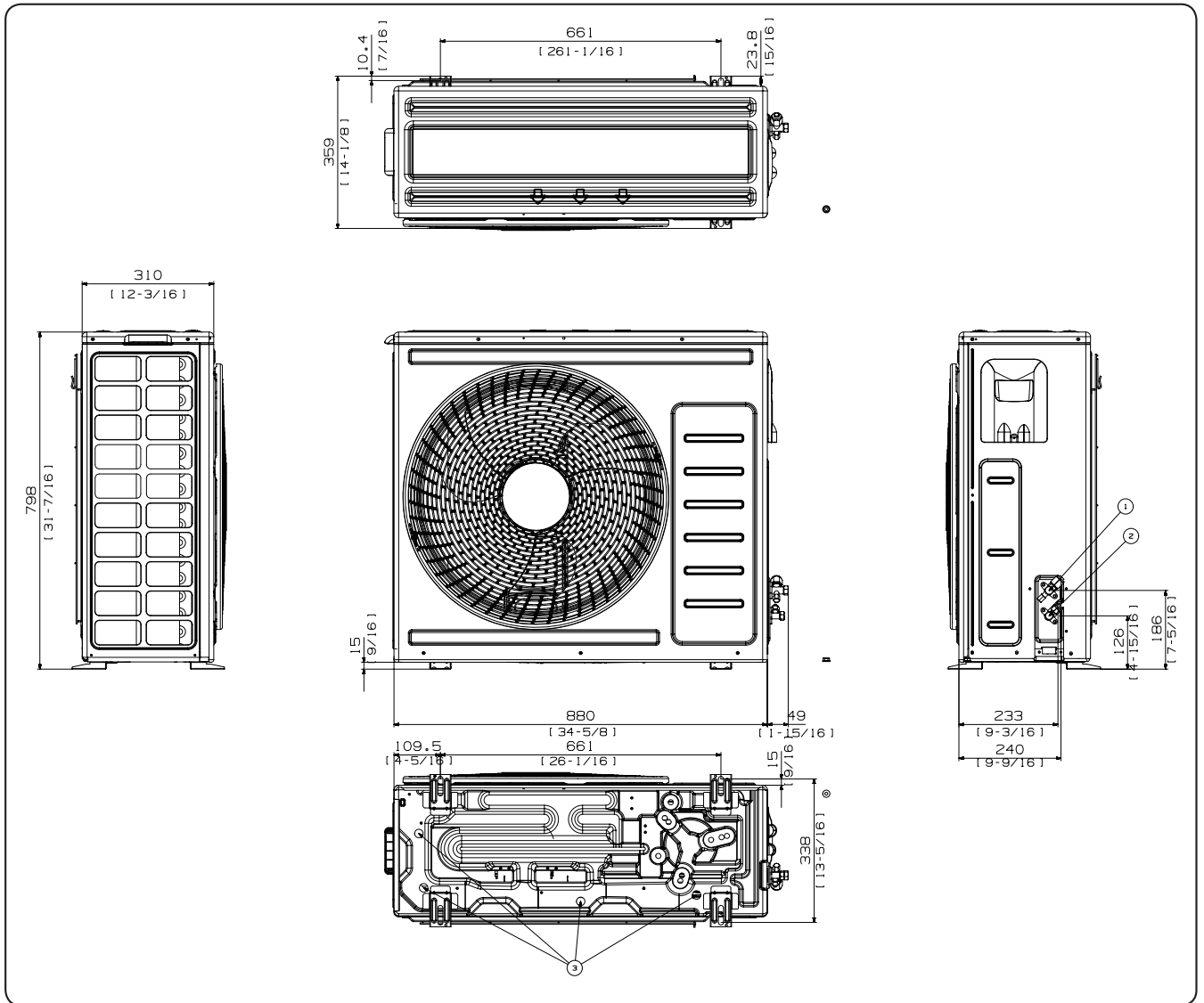

No.	Name	Description
1	Refrigerant gas pipe	Φ15.88(5/8)
2	Refrigerant liquid pipe	Φ6.35(1/4)
3	Drain Hole	Connection with the provided drain plug.

# 2. Dimensional Drawing

## Outdoor Units

### AC100/120RXAD\*G/EU

Units : mm [inches]

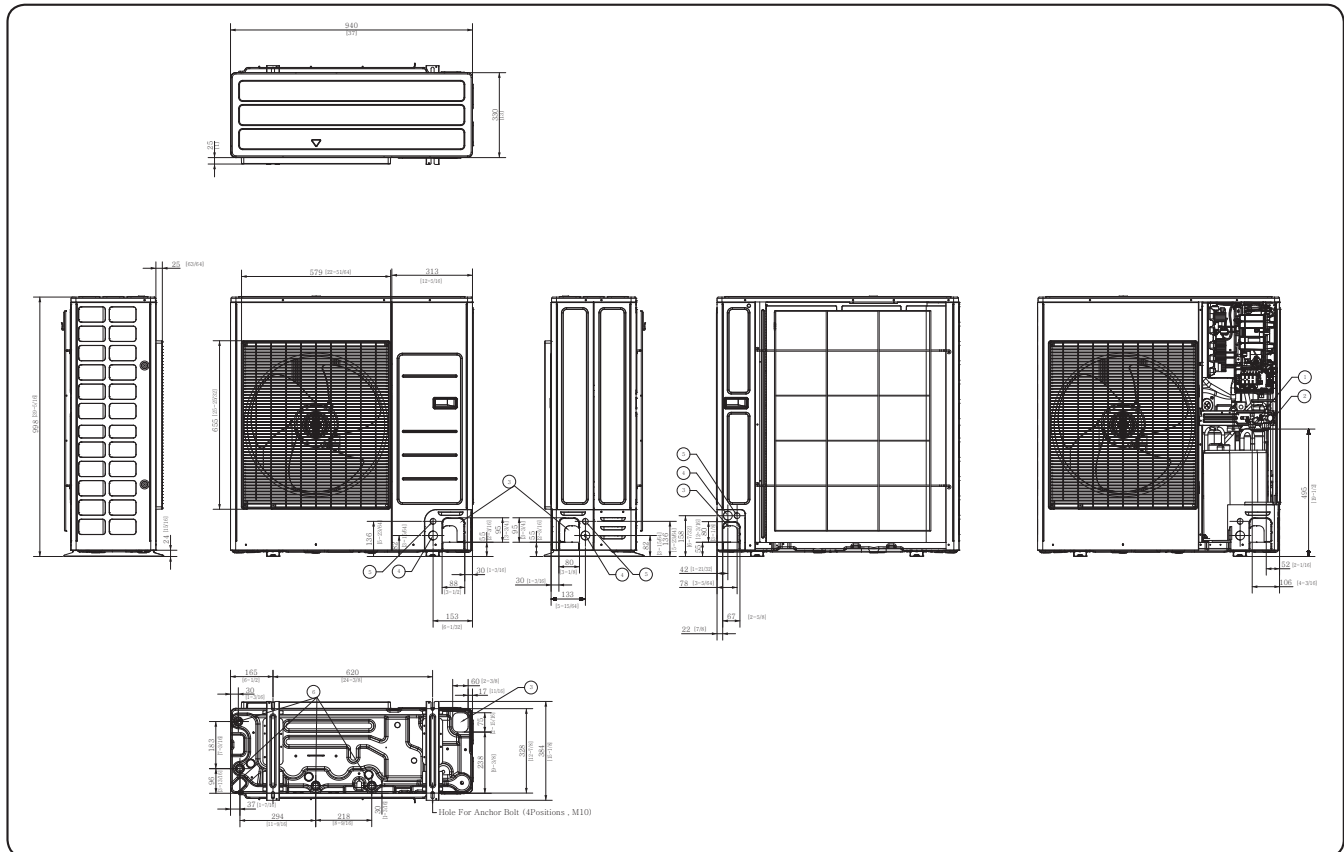

No.	Name	Description
1	Liquid pipe connection	Ø9.52 (3/8)
2	Gas pipe connection	Ø15.88 (5/8)
3	Piping intake knockout hole	Front / Side / Rear / Bottom
4	Power wiring conduit	Front / Side / Rear / Ø34 (1-3/8)
5	Communication wiring conduit	Front / Side / Rear / Ø22 (7/8)
6	Drain hole	Connect with the provided drain plug.

# 2. Dimensional Drawing

## Outdoor Units

### AC140RXAD\*G/EU

Units : mm [inches]

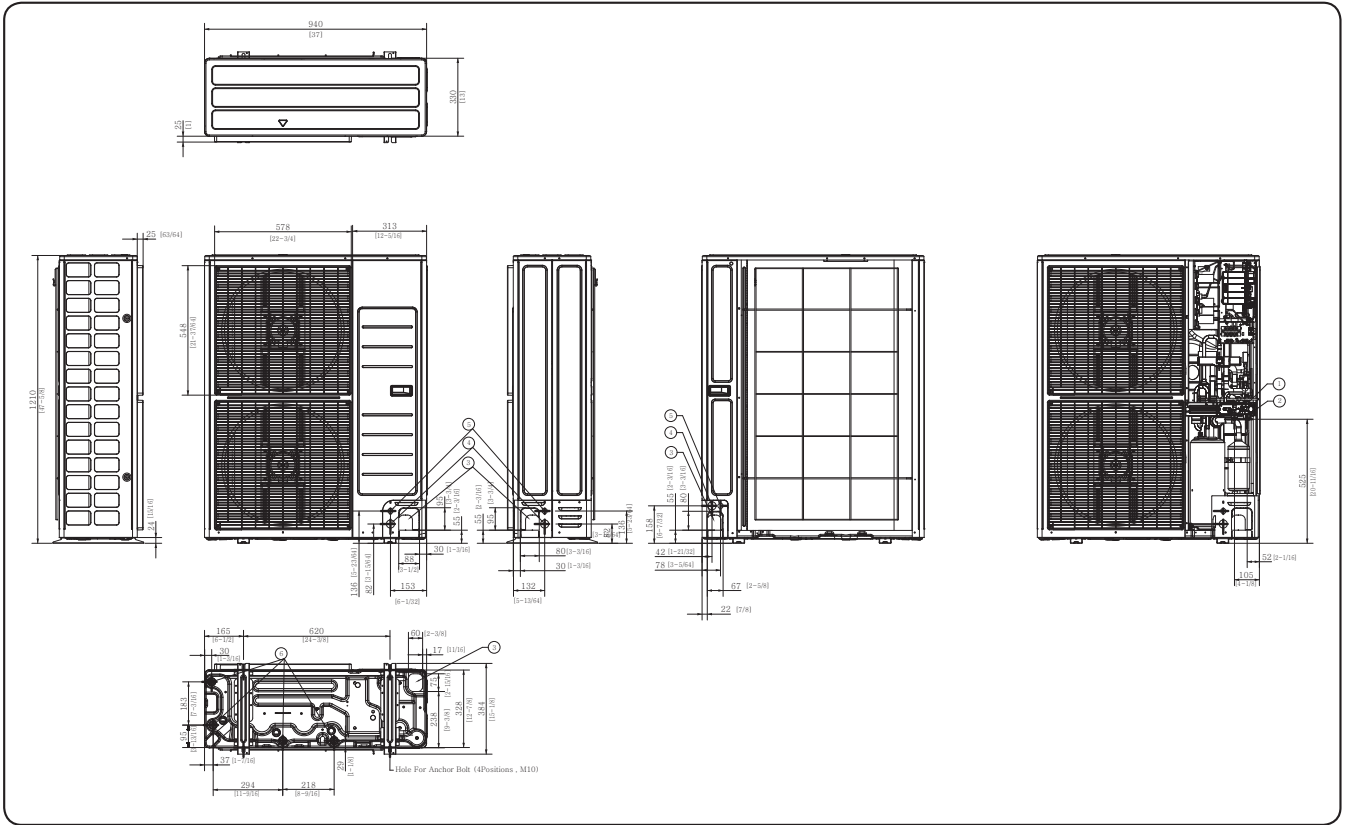

No.	Name	Description
1	Liquid pipe connection	Ø9.52 (3/8)
2	Gas pipe connection	Ø15.88 (5/8)
3	Piping intake knockout hole	Front / Side / Rear / Bottom
4	Power wiring conduit	Front / Side / Rear / Ø34 (1-3/8)
5	Communication wiring conduit	Front / Side / Rear / Ø22 (7/8)
6	Drain hole	Connect with the provided drain plug.

# 3. Center of Gravity

## Outdoor Units

### AC026/035RXADKG/EU

Units : mm [inches]

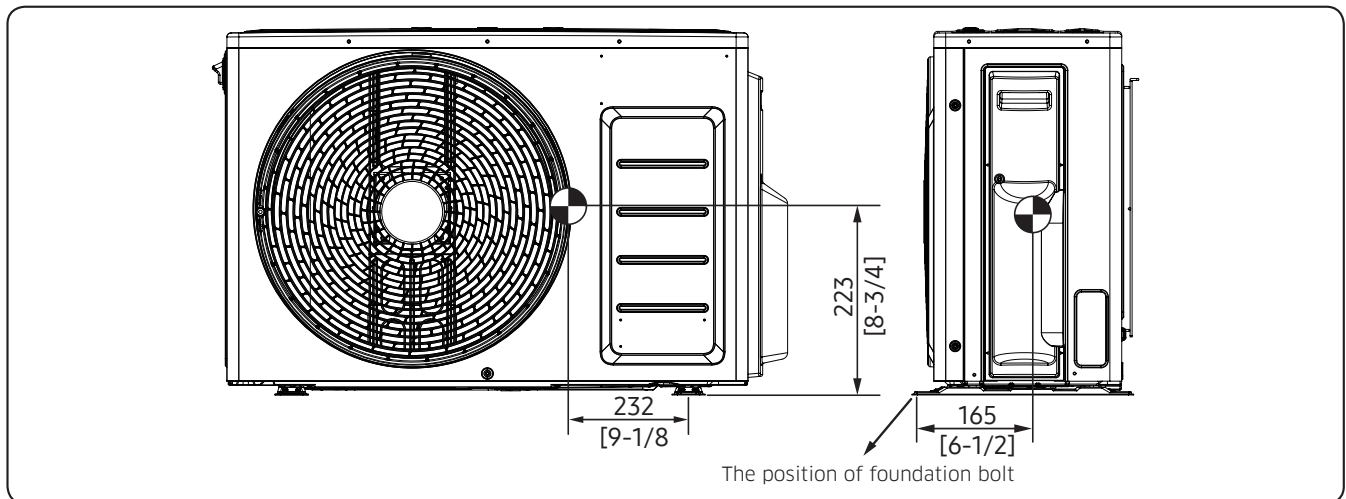

### AC052RXADKG/EU

Units : mm [inches]

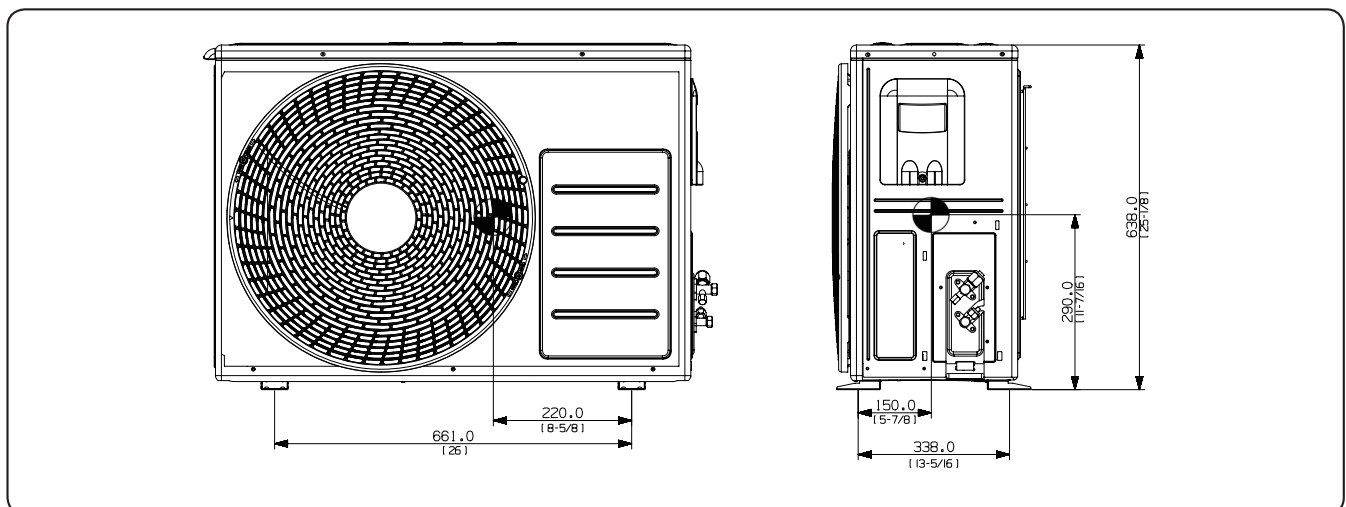



# 3. Center of Gravity

## Outdoor Units

### AC071RXADKG/EU

Units : mm [inches]

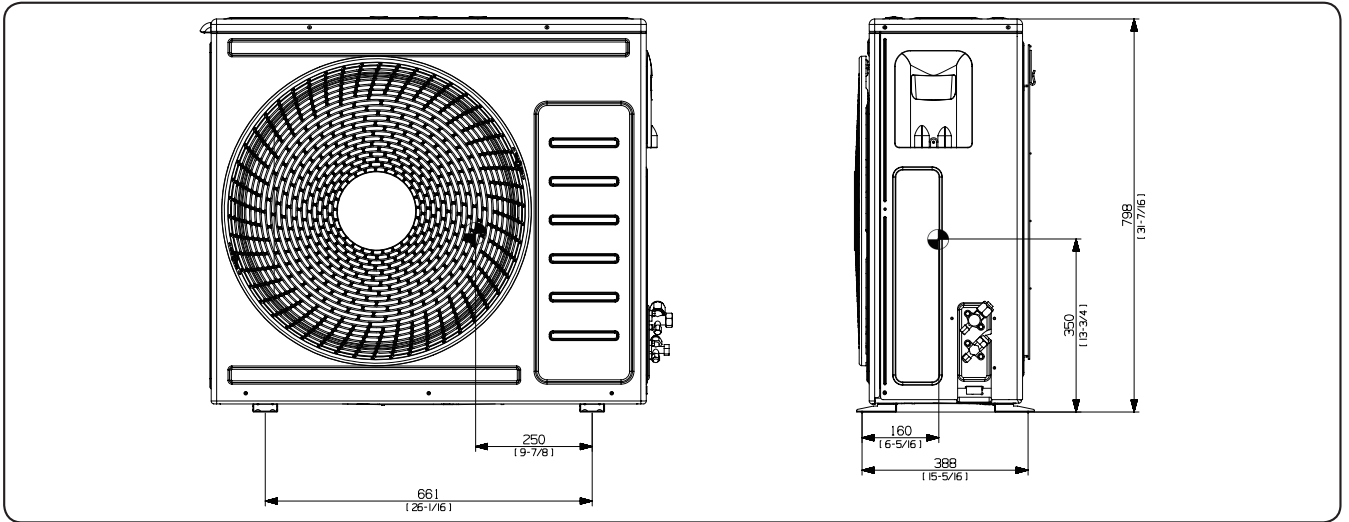

### AC100/120RXAD\*G/EU

Units : mm [inches]

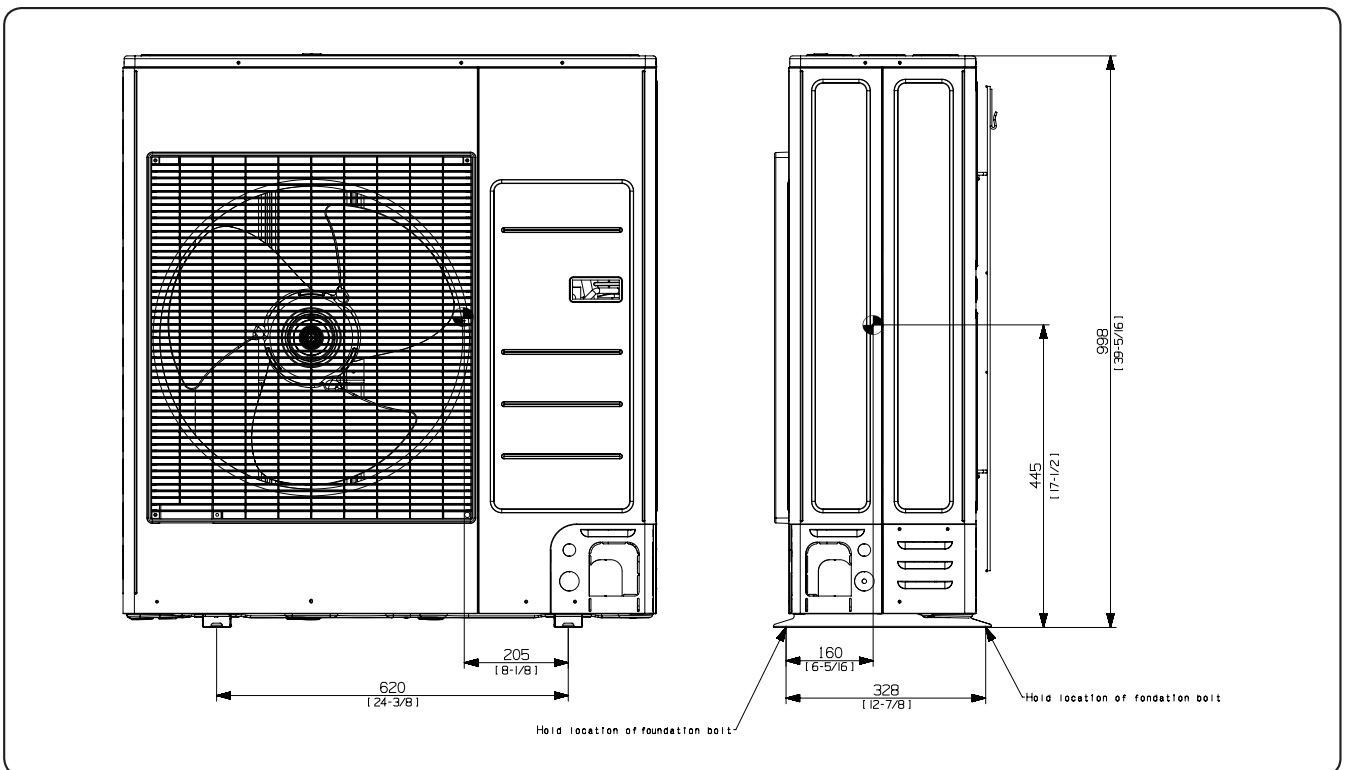

# 3. Center of Gravity

## Outdoor Units

AC140RXAD\*G/EU

Units : mm [inches]

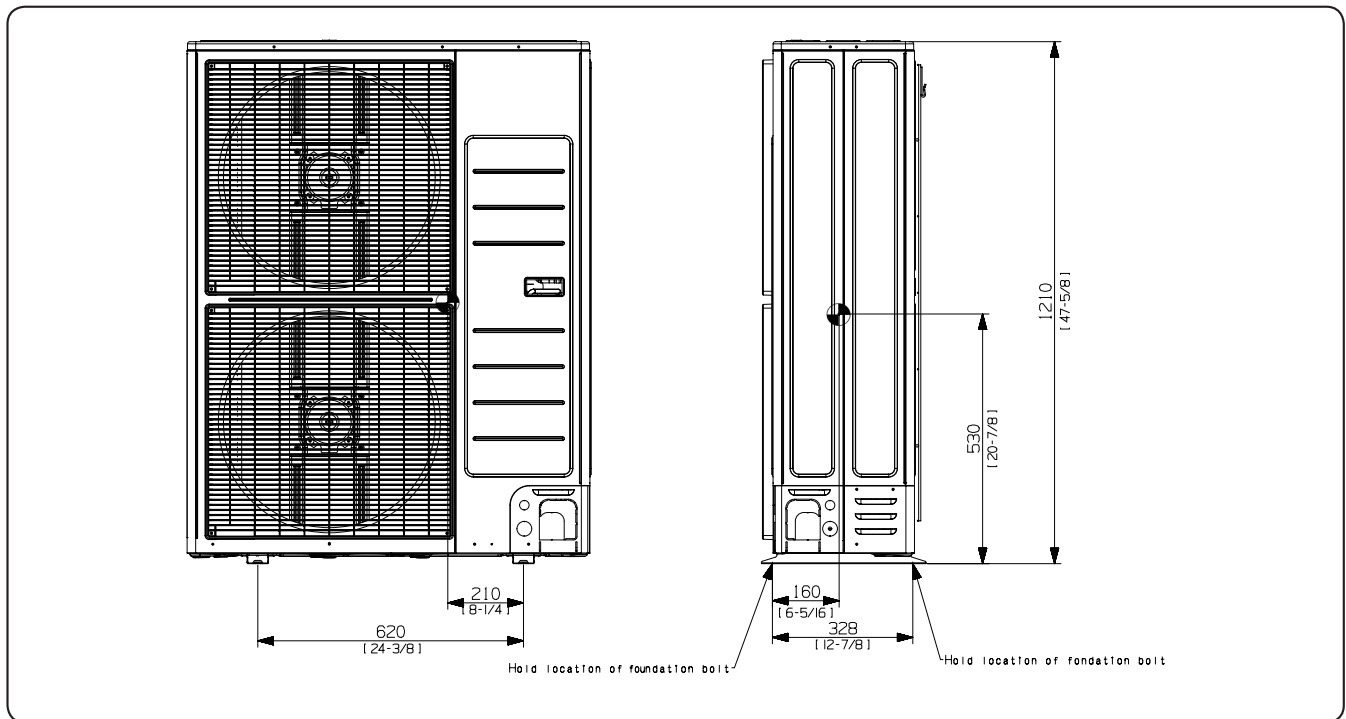

# 4. Electrical Wiring Diagram

## Outdoor Units

### AC026/035RXADKG/EU

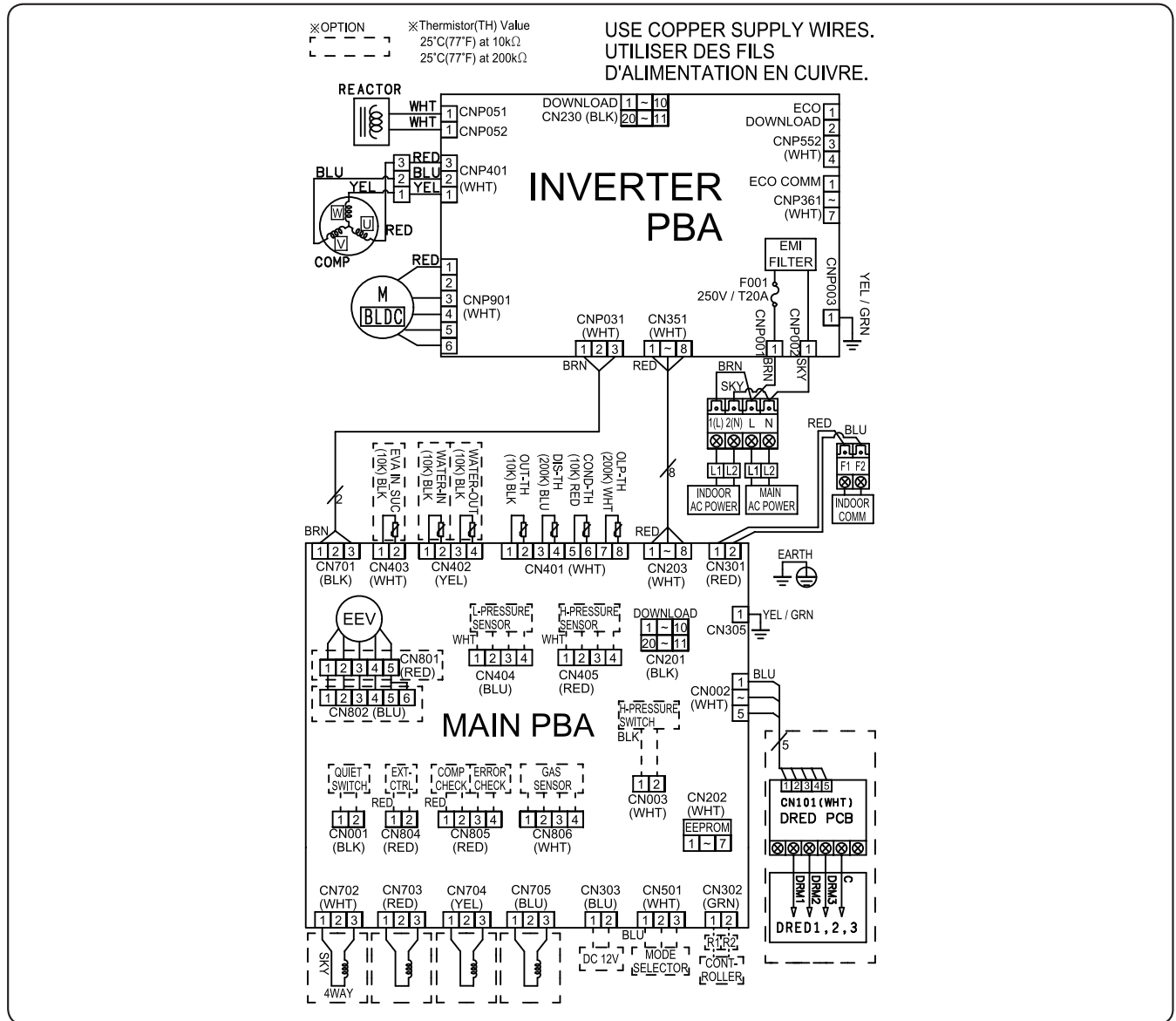

DRED PCB	Printed circuit board(DRED)	H-PRESSURE SWITCH	High Pressure Switch	M-BLDC	BLDC Motor
EEV	Electronic Expansion Valve	OUT-TH(10K)	Thermistor AMBIENT	DIS-TH(200K)	Thermistor DISCHARGE
COND-TH(10K)	Thermistor CONDENSOR	OLP-TH(200K)	Thermistor OLP		

#### NOTE

- This wiring diagram applies only to the outdoor unit.
- Colors blk: black, red: red, blu: blue, wht: white, yel: yellow, brn: brown, sky: skyblue
- When operating, don't shortcircuit the protection device (High Pressure switch)
- For connection wiring indoor-outdoor transmission F1-F2, outdoor-outdoor transmission OF1-OF2, refer to the installation manual.
- Protective earth(screw), : connector, : The wire quantity

# 4. Electrical Wiring Diagram

## Outdoor Units

### AC052/071RXADKG/EU

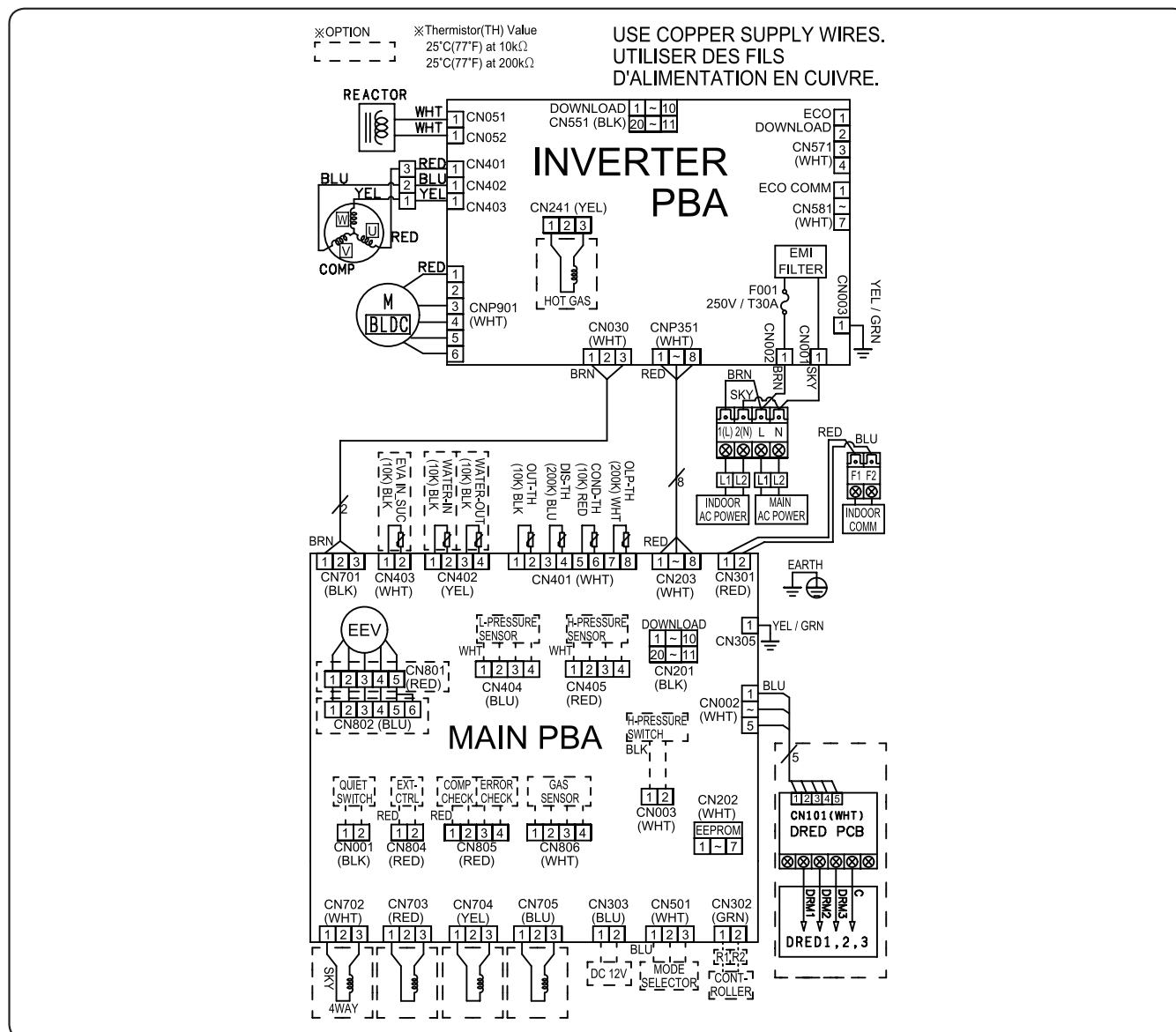

DRED PCB	Printed circuit board(DRED)	H-PRESSURE SWITCH	High Pressure Switch	M-BLDC	BLDC Motor
EEV	Electronic Expansion Valve	OUT-TH(10K)	Thermistor AMBIENT	DIS-TH(200K)	Thermistor DISCHARGE
COND-TH(10K)	Thermistor CONDENSOR	OLP-TH(200K)	Thermistor OLP		

### NOTE

- This wiring diagram applies only to the outdoor unit.
- Colors blk: black, red: red, blu: blue, wht: white, yel: yellow, brn: brown, sky: skyblue
- When operating, don't shortcircuit the protection device (High Pressure switch)
- For connection wiring indoor-outdoor transmission F1-F2, outdoor-outdoor transmission OF1-OF2, refer to the installation manual.
- Protective earth(screw), : connector, : The wire quantity

# 4. Electrical Wiring Diagram

## Outdoor Units

### AC100/120/140RXADKG/EU

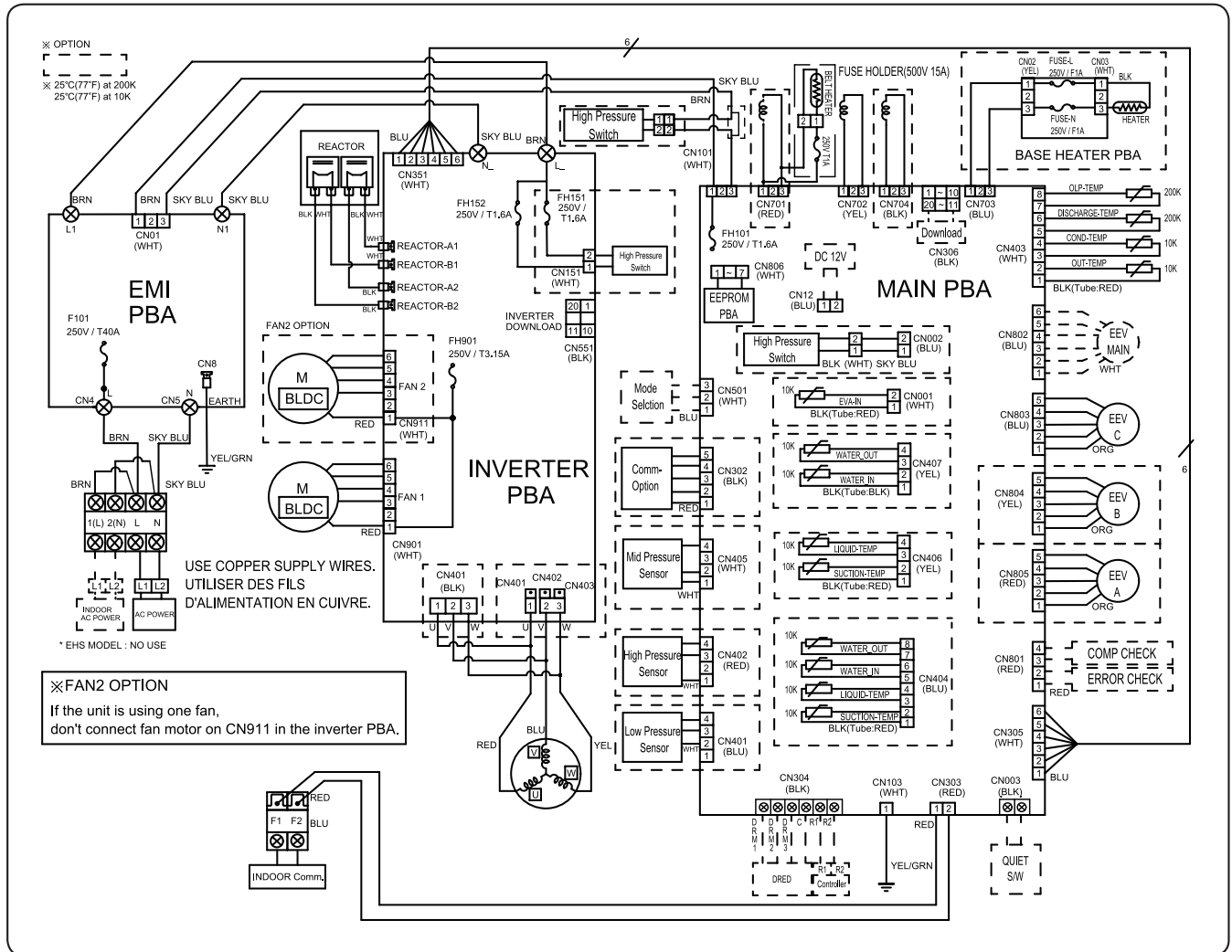

DRED PCB	Printed circuit board(DRED)	BASE HEATER PBA	Printed circuit board(BASE HEATER)	M-BLDC	BLDC Motor
EEV	Electronic Expansion Valve	OUT-Temp(10K)	Thermistor AMBIENT	COND Temp(10K)	Thermistor DISCHARGE
DISCHARGE Temp(200K)	Thermistor CONDENSOR	OLP Temp(200K)	Thermistor OLP		

### NOTE

- This wiring diagram applies only to the outdoor unit.
- Colors blk: black, red: red, blu: blue, wht: white, yel: yellow, brn: brown, sky: skyblue
- When operating, don't shortcircuit the protection device (High Pressure switch)
- For connection wiring indoor-outdoor transmission F1-F2, outdoor-outdoor transmission OF1-OF2, refer to the installation manual.
- ⊕ Protective earth(screw), □□□□ : connector,  $\overline{N}$  : The wire quantity

# 4. Electrical Wiring Diagram

## Outdoor Units

### AC100/120/140RXADNG/EU

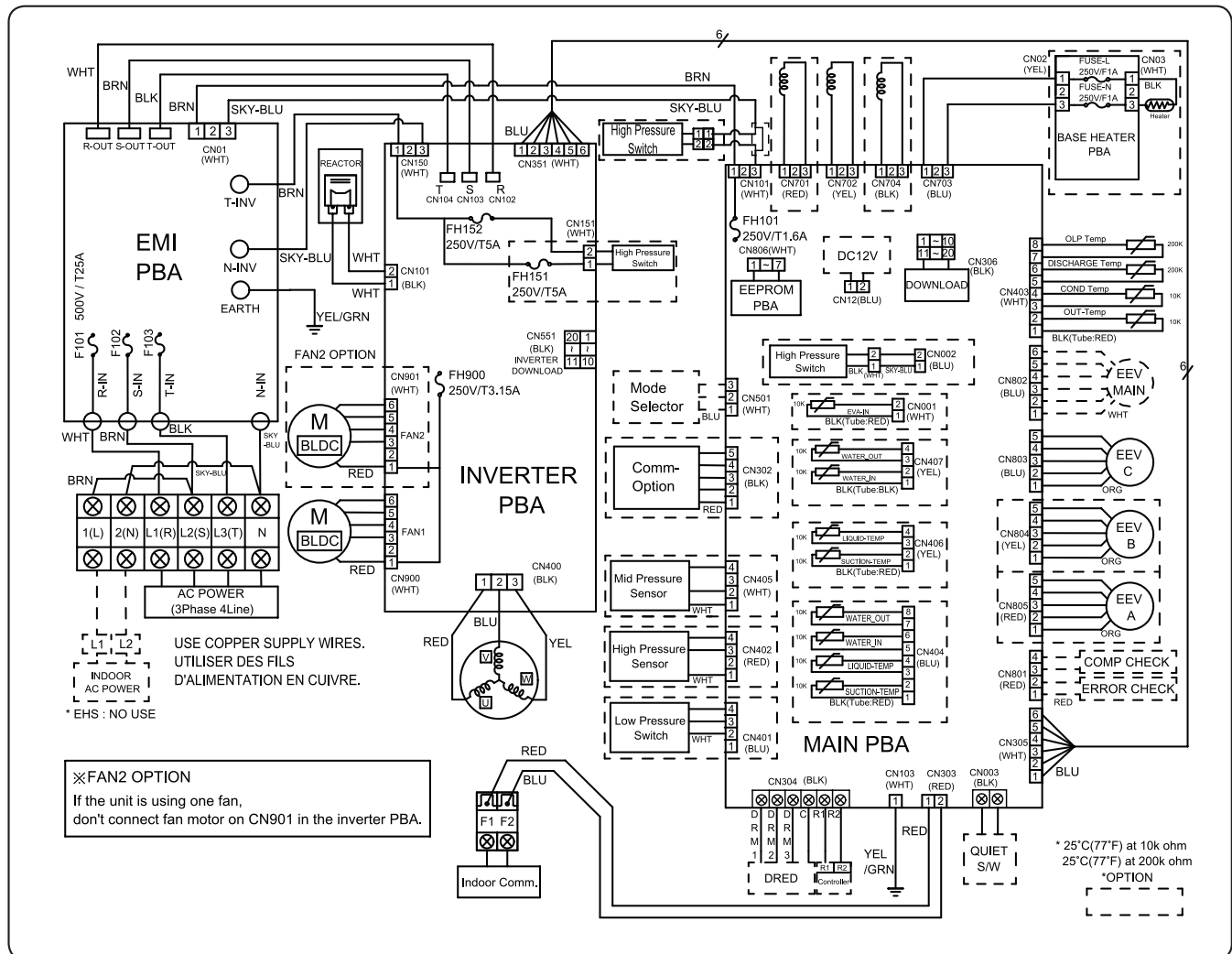

DRED PCB	Printed circuit board(DRED)	BASE HEATER PBA	Printed circuit board(BASE HEATER)	M-BLDC	BLDC Motor
EEV	Electronic Expansion Valve	OUT-Temp(10K)	Thermistor AMBIENT	COND Temp(10K)	Thermistor DISCHARGE
DISCHARGE Temp(200K)	Thermistor CONDENSOR	OLP Temp(200K)	Thermistor OLP		

### NOTE

- This wiring diagram applies only to the outdoor unit.
- Colors blk: black, red: red, blu: blue, wht: white, yel: yellow, brn: brown, sky: skyblue
- When operating, don't shortcircuit the protection device (High Pressure switch)
- For connection wiring indoor-outdoor transmission F1-F2, outdoor-outdoor transmission OF1-OF2, refer to the installation manual.
- Protective earth(screw), : connector, : The wire quantity

# 5. Sound Data

## Outdoor Units

### Sound Pressure level

Unit: dB(A)

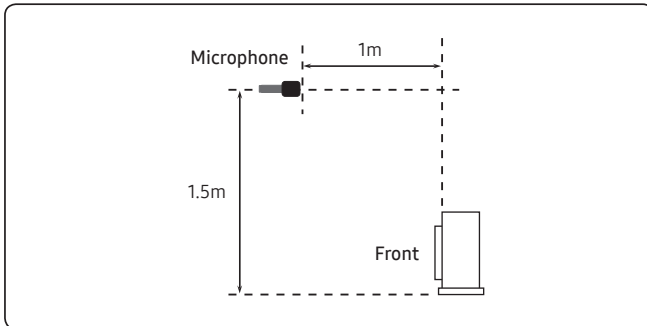

Model	Cooling	Heating
AC026RXADKG/EU	46	47
AC035RXADKG/EU	48	48
AC052RXADKG/EU	48	48
AC071RXADKG/EU	49	51

- NR Curve

1) AC026RXADKG/EU

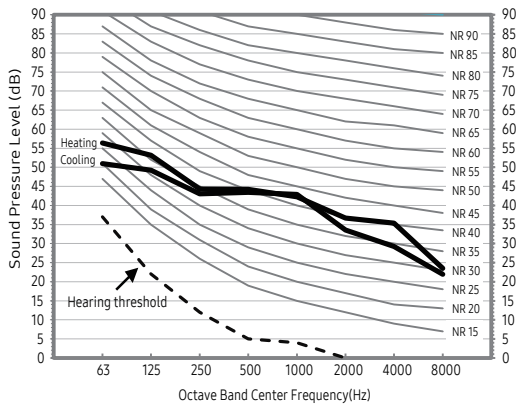

2) AC035RXADKG/EU

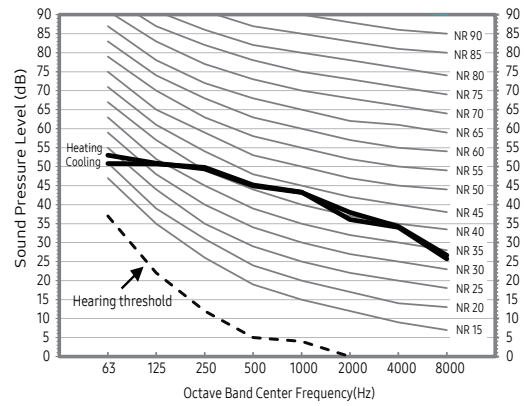

3) AC052RXADKG/EU

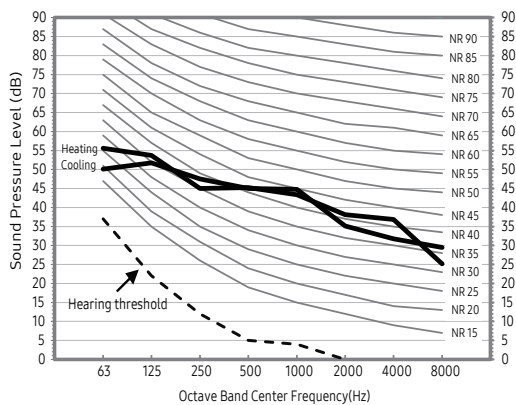

4) AC071RXADKG/EU

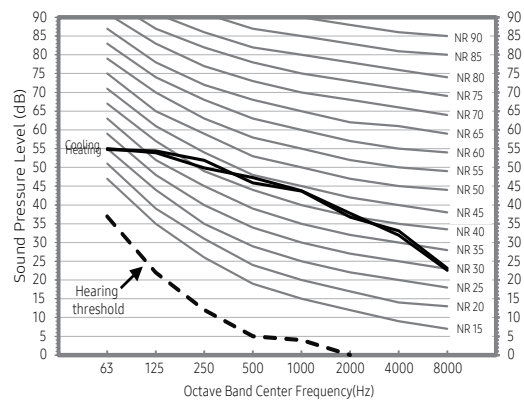

**NOTE**

- Specifications may be subject to change without prior notice.
  - Sound pressure level is obtained in an anechoic room.
  - Sound pressure level is a relative value, depending on the distance and acoustic environment.
  - Sound pressure level may differ depending on operation condition.
  - dB(A) = A weighted sound pressure level
  - Reference acoustic pressure 0 dB = 20μPa

# 5. Sound Data

## Outdoor Units

### Sound Pressure level

Unit: dB(A)

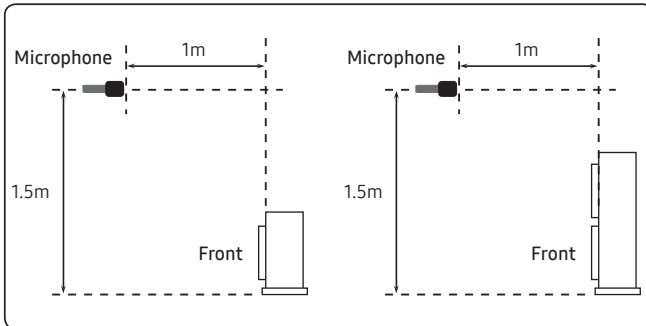

Model	Cooling	Heating
AC100RXAD*G/EU	52	54
AC120RXAD*G/EU	54	56
AC140RXAD*G/EU	53	54

- NR Curve

5) AC100RXAD\*G/EU

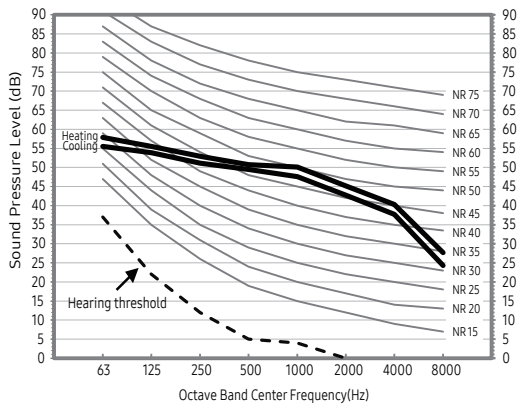

6) AC120RXAD\*G/EU

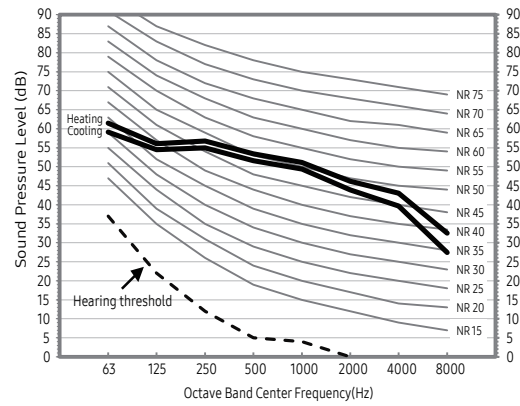

7) AC140RXAD\*G/EU

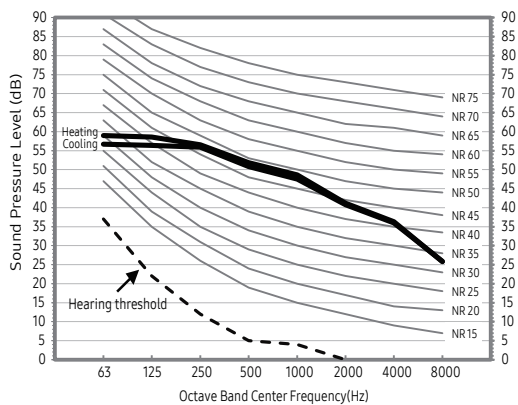

### NOTE

- Specifications may be subject to change without prior notice.
  - Sound pressure level is obtained in an anechoic room.
  - Sound pressure level is a relative value, depending on the distance and acoustic environment.
  - Sound pressure level may differ depending on operation condition.
  - dBA = A weighted sound pressure level
  - Reference acoustic pressure 0 dB = 20μPa



# 5. Sound Data

## Outdoor Units

### Sound Power level

**NOTE**

Unit: dB(A)

- Specifications may be subject to change without prior notice
  - Sound power level is an absolute value that a sound source generates.
  - dBA = A-weighted sound power level.
  - Reference power : 1pW.
  - Measured according to ISO 3741.

Model	Power
AC026RXADKG/EU	59
AC035RXADKG/EU	61
AC052RXADKG/EU	62
AC071RXADKG/EU	65

• NR Curve

1) AC026RXADKG/EU

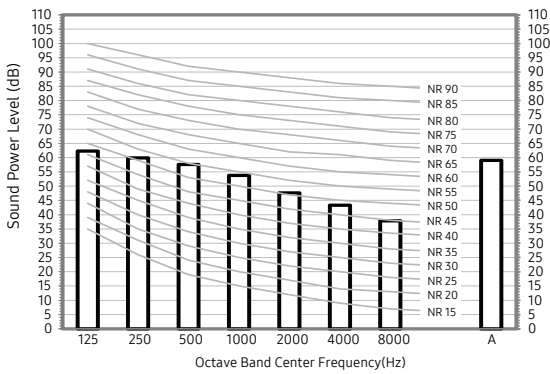

2) AC035RXADKG/EU

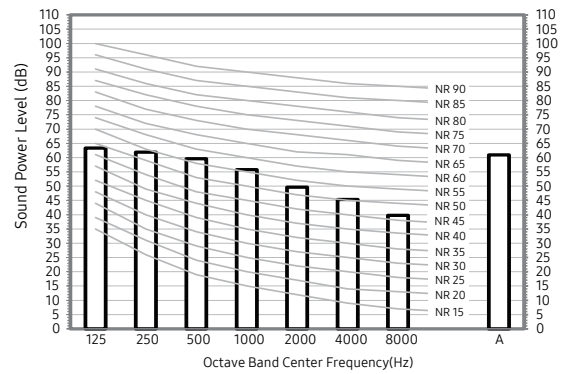

3) AC052RXADKG/EU

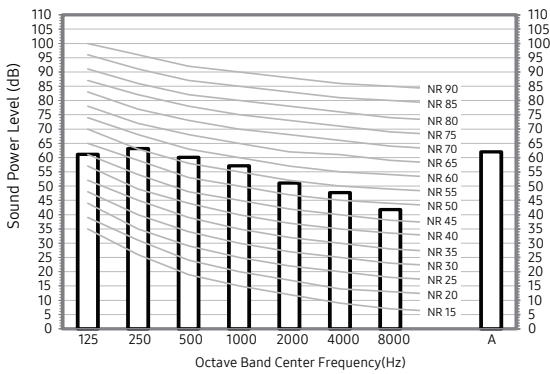

4) AC071RXADKG/EU

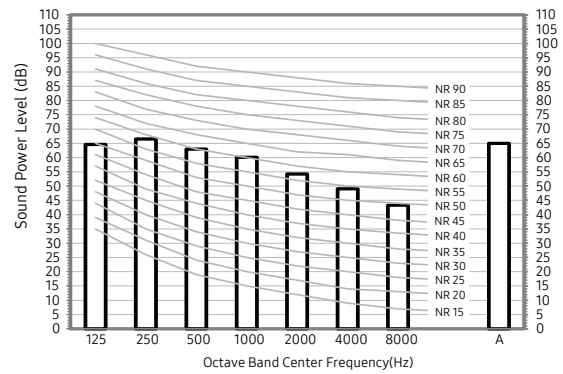

# 5. Sound Data

## Outdoor Units

### Sound Power level

**NOTE**

- Specifications may be subject to change without prior notice
  - Sound power level is an absolute value that a sound source generates.
  - dBA = A-weighted sound power level.
  - Reference power : 1pW.
  - Measured according to ISO 3741.

Unit: dB(A)

Model	Power
AC100RXAD*G/EU	69
AC120RXAD*G/EU	70
AC140RXAD*G/EU	69

- NR Curve

5) AC100RXAD\*G/EU

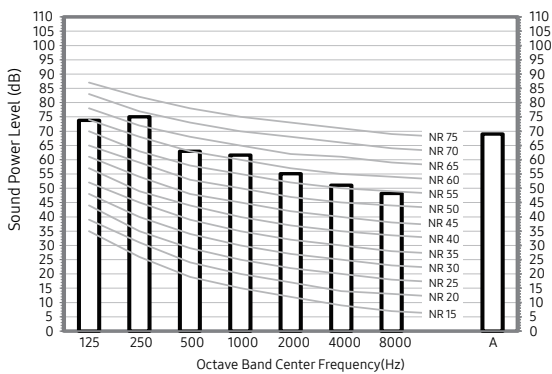

6) AC120RXAD\*G/EU

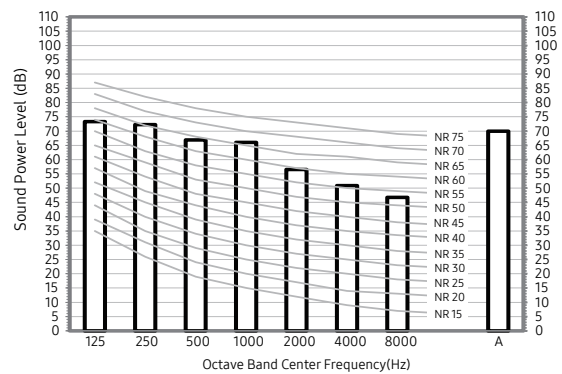

7) AC140RXAD\*G/EU

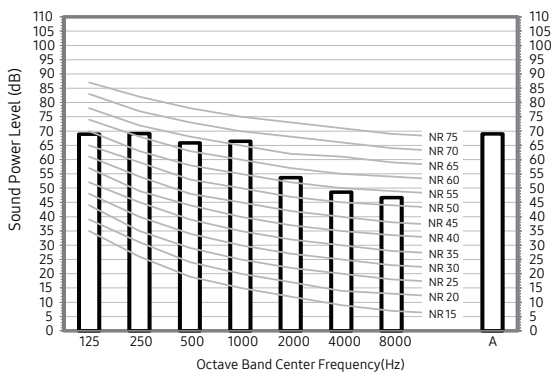

# 6. Capacity Correction

## Outdoor Units

AC026/035RXADKG/EU

### Cooling



		Pipe Length (m)			
		5	10	15	20
Level Difference (m)	30	-	-	-	-
	25	-	-	-	-
	20	-	-	-	-
	15	-	-	-	0.92
	10	-	-	0.95	0.92
	5	-	0.97	0.95	0.92
	0	1	0.97	0.95	0.92
	-5	-	0.96	0.94	0.91
	-10	-	-	0.92	0.90
	-15	-	-	-	0.88
	-20	-	-	-	-
	-25	-	-	-	-
	-30	-	-	-	-

### Heating



		Pipe Length (m)			
		5	10	15	20
Level Difference (m)	30	-	-	-	-
	25	-	-	-	-
	20	-	-	-	-
	15	-	-	-	0.92
	10	-	-	0.95	0.92
	5	-	0.97	0.95	0.92
	0	1	0.97	0.95	0.92
	-5	-	0.97	0.95	0.92
	-10	-	-	0.95	0.92
	-15	-	-	-	0.92
	-20	-	-	-	-
	-25	-	-	-	-
	-30	-	-	-	-

# 6. Capacity Correction

## Outdoor Units

AC052RXADKG/EU

### Cooling



		Pipe Length (m)					
		5	10	15	20	25	30
Level Difference (m)	30	-	-	-	-	-	-
	25	-	-	-	-	-	-
	20	-	-	-	-	0.92	0.90
	15	-	-	-	0.94	0.92	0.90
	10	-	-	0.96	0.94	0.92	0.90
	5	-	0.98	0.96	0.94	0.92	0.90
	0	1	0.98	0.96	0.94	0.92	0.90
	-5	-	0.97	0.95	0.93	0.91	0.89
	-10	-	-	0.94	0.93	0.91	0.89
	-15	-	-	-	0.92	0.90	0.88
	-20	-	-	-	-	0.89	0.86
	-25	-	-	-	-	-	-
	-30	-	-	-	-	-	-

### Heating



		Pipe Length (m)					
		5	10	15	20	25	30
Level Difference (m)	30	-	-	-	-	-	-
	25	-	-	-	-	-	-
	20	-	-	-	-	0.94	0.92
	15	-	-	-	0.95	0.94	0.92
	10	-	-	0.97	0.95	0.94	0.92
	5	-	0.98	0.97	0.95	0.94	0.92
	0	1	0.98	0.97	0.95	0.94	0.92
	-5	-	0.98	0.97	0.95	0.94	0.92
	-10	-	-	0.97	0.95	0.94	0.92
	-15	-	-	-	0.95	0.94	0.92
	-20	-	-	-	-	0.94	0.92
	-25	-	-	-	-	-	-
	-30	-	-	-	-	-	-

# 6. Capacity Correction

## Outdoor Units

AC071/100/120RXAD\*G/EU

### Cooling



		Pipe Length (m)									
		5	10	15	20	25	30	35	40	45	50
Level Difference (m)	30	-	-	-	-	-	-	0.93	0.92	0.91	0.90
	25	-	-	-	-	-	0.94	0.93	0.92	0.91	0.90
	20	-	-	-	-	0.96	0.94	0.93	0.92	0.91	0.90
	15	-	-	-	0.97	0.96	0.94	0.93	0.92	0.91	0.90
	10	-	-	0.98	0.97	0.96	0.94	0.93	0.92	0.91	0.90
	5	-	0.99	0.98	0.97	0.96	0.94	0.93	0.92	0.91	0.90
	0	1	0.99	0.98	0.97	0.96	0.94	0.93	0.92	0.91	0.90
	-5	-	0.98	0.97	0.96	0.95	0.94	0.93	0.92	0.91	0.89
	-10	-	-	0.97	0.96	0.95	0.94	0.92	0.91	0.90	0.88
	-15	-	-	-	0.95	0.95	0.93	0.92	0.91	0.89	0.88
	-20	-	-	-	-	0.94	0.93	0.92	0.90	0.89	0.87
	-25	-	-	-	-	-	0.92	0.91	0.90	0.88	0.86
	-30	-	-	-	-	-	-	0.91	0.89	0.88	0.85

### Heating



		Pipe Length (m)									
		5	10	15	20	25	30	35	40	45	50
Level Difference (m)	30	-	-	-	-	-	-	0.95	0.94	0.93	0.92
	25	-	-	-	-	-	0.96	0.95	0.94	0.93	0.92
	20	-	-	-	-	0.96	0.96	0.95	0.94	0.93	0.92
	15	-	-	-	0.97	0.96	0.96	0.95	0.94	0.93	0.92
	10	-	-	0.98	0.97	0.96	0.96	0.95	0.94	0.93	0.92
	5	-	0.99	0.98	0.97	0.96	0.96	0.95	0.94	0.93	0.92
	0	1	0.99	0.98	0.97	0.96	0.96	0.95	0.94	0.93	0.92
	-5	-	0.99	0.98	0.97	0.96	0.96	0.95	0.94	0.93	0.92
	-10	-	-	0.98	0.97	0.96	0.96	0.95	0.94	0.93	0.92
	-15	-	-	-	0.97	0.96	0.96	0.95	0.94	0.93	0.92
	-20	-	-	-	-	0.96	0.96	0.95	0.94	0.93	0.92
	-25	-	-	-	-	-	0.96	0.95	0.94	0.93	0.92
	-30	-	-	-	-	-	-	0.95	0.94	0.93	0.92

# 6. Capacity Correction

## Outdoor Units

AC140RXAD\*G/EU

### Cooling



		Pipe Length (m)														
		5	10	15	20	25	30	35	40	45	50	55	60	65	70	75
Level Difference (m)	30	-	-	-	-	-	-	0.95	0.94	0.93	0.92	0.91	0.91	0.90	0.89	0.88
	25	-	-	-	-	-	0.96	0.95	0.94	0.93	0.92	0.91	0.91	0.90	0.89	0.88
	20	-	-	-	-	0.97	0.96	0.95	0.94	0.93	0.92	0.91	0.91	0.90	0.89	0.88
	15	-	-	-	0.97	0.97	0.96	0.95	0.94	0.93	0.92	0.91	0.91	0.90	0.89	0.88
	10	-	-	0.98	0.97	0.97	0.96	0.95	0.94	0.93	0.92	0.91	0.91	0.90	0.89	0.88
	5	-	0.99	0.98	0.97	0.97	0.96	0.95	0.94	0.93	0.92	0.91	0.91	0.90	0.89	0.88
	0	1	0.99	0.98	0.97	0.97	0.96	0.95	0.94	0.93	0.92	0.91	0.91	0.90	0.89	0.88
	-5	-	0.99	0.98	0.97	0.96	0.95	0.95	0.94	0.93	0.92	0.91	0.90	0.89	0.88	0.87
	-10	-	-	0.98	0.97	0.96	0.95	0.94	0.93	0.93	0.92	0.91	0.90	0.89	0.88	0.86
	-15	-	-	-	0.97	0.96	0.95	0.94	0.93	0.92	0.91	0.90	0.89	0.88	0.87	0.85
	-20	-	-	-	-	0.95	0.95	0.94	0.93	0.92	0.91	0.90	0.89	0.88	0.86	0.84
	-25	-	-	-	-	-	0.94	0.93	0.93	0.92	0.91	0.90	0.89	0.87	0.86	0.83
	-30	-	-	-	-	-	-	0.93	0.92	0.91	0.90	0.89	0.88	0.87	0.85	0.82

### Heating



		Pipe Length (m)														
		5	10	15	20	25	30	35	40	45	50	55	60	65	70	75
Level Difference (m)	30	-	-	-	-	-	-	0.96	0.95	0.94	0.94	0.93	0.92	0.91	0.91	0.90
	25	-	-	-	-	-	0.96	0.96	0.95	0.94	0.94	0.93	0.92	0.91	0.91	0.90
	20	-	-	-	-	0.97	0.96	0.96	0.95	0.94	0.94	0.93	0.92	0.91	0.91	0.90
	15	-	-	-	0.98	0.97	0.96	0.96	0.95	0.94	0.94	0.93	0.92	0.91	0.91	0.90
	10	-	-	0.99	0.98	0.97	0.96	0.96	0.95	0.94	0.94	0.93	0.92	0.91	0.91	0.90
	5	-	0.99	0.99	0.98	0.97	0.96	0.96	0.95	0.94	0.94	0.93	0.92	0.91	0.91	0.90
	0	1	0.99	0.99	0.98	0.97	0.96	0.96	0.95	0.94	0.94	0.93	0.92	0.91	0.91	0.90
	-5	-	0.99	0.99	0.98	0.97	0.96	0.96	0.95	0.94	0.94	0.93	0.92	0.91	0.91	0.90
	-10	-	-	0.99	0.98	0.97	0.96	0.96	0.95	0.94	0.94	0.93	0.92	0.91	0.91	0.90
	-15	-	-	-	0.98	0.97	0.96	0.96	0.95	0.94	0.94	0.93	0.92	0.91	0.91	0.90
	-20	-	-	-	-	0.97	0.96	0.96	0.95	0.94	0.94	0.93	0.92	0.91	0.91	0.90
	-25	-	-	-	-	-	0.96	0.96	0.95	0.94	0.94	0.93	0.92	0.91	0.91	0.90
	-30	-	-	-	-	-	-	0.96	0.95	0.94	0.94	0.93	0.92	0.91	0.91	0.90

## 7. Operation Range

---

### AC026/035RXADKG/EU

Mode	Outdoor Unit	Indoor Unit	Indoor Unit
	Temperature(DB)	Temperature(DB)	Humidity(RH)
Cooling	-15°C ~ 46°C	18°C ~ 32°C	80% or less
Heating	-20°C ~ 24°C	30°C or less	-
Drying	-15°C ~ 46°C	18°C ~ 32°C	80% or less

### AC052/071/100/120RXAD\*G/EU

Mode	Outdoor Unit	Indoor Unit	Indoor Unit
	Temperature(DB)	Temperature(DB)	Humidity(RH)
Cooling	-15°C ~ 50°C	18°C ~ 32°C	80% or less
Heating	-20°C ~ 24°C	30°C or less	-
Drying	-15°C ~ 50°C	18°C ~ 32°C	80% or less

#### NOTE

- The assumed installation conditions are follows
  - The pipe length(including elbow) is 5 m.
  - The level difference is 0 m.





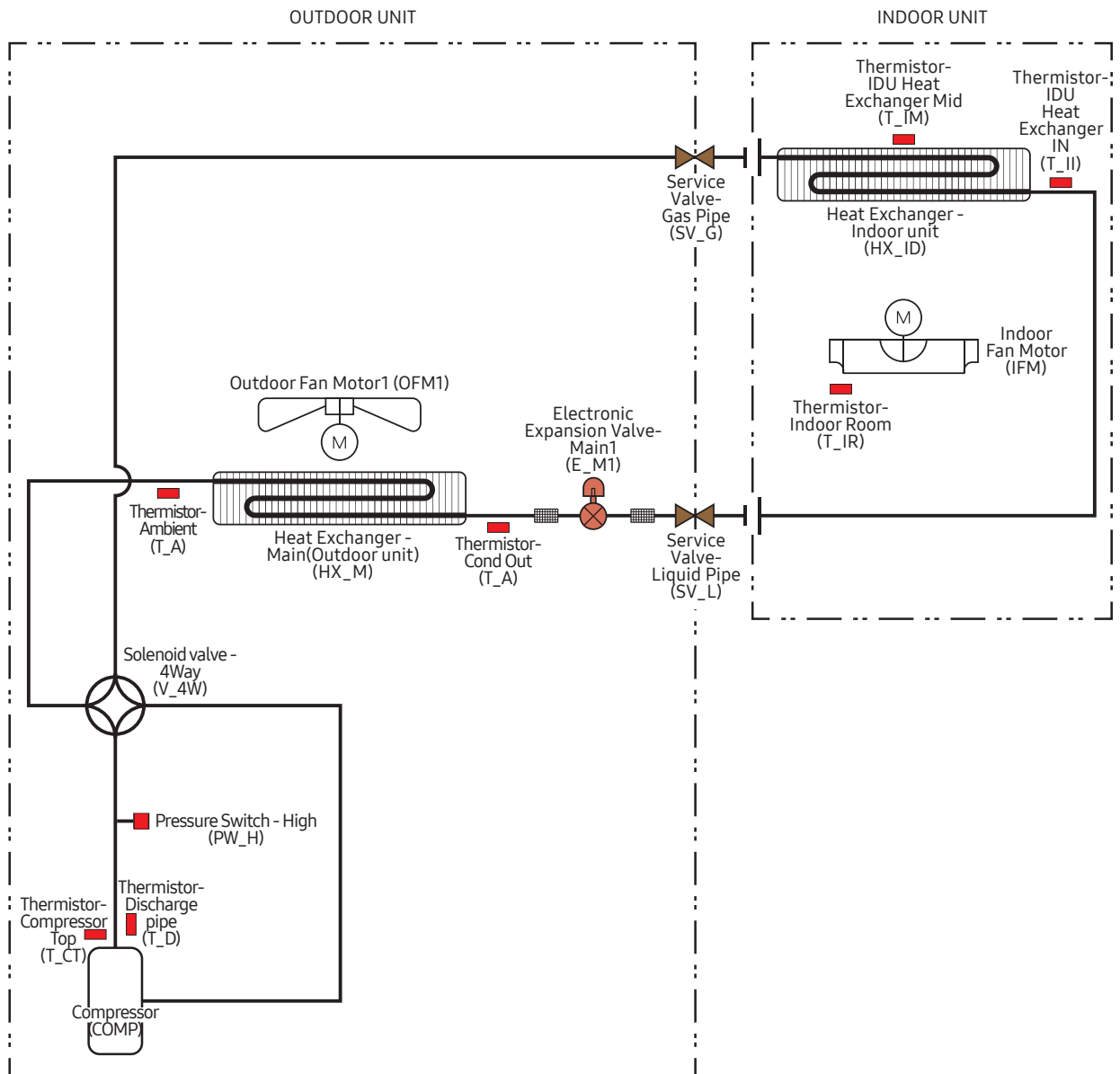





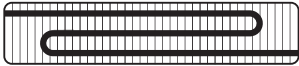





# 8. Piping Diagram

AC026RNNDKG/EU+AC026RXADKG/EU  
 AC026RNJDKG/EU+AC026RXADKG/EU  
 AC035RNNDKG/EU+AC035RXADKG/EU  
 AC035RNJDKG/EU+AC035RXADKG/EU



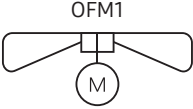
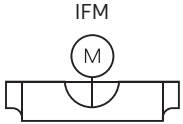

# 8. Piping Diagram







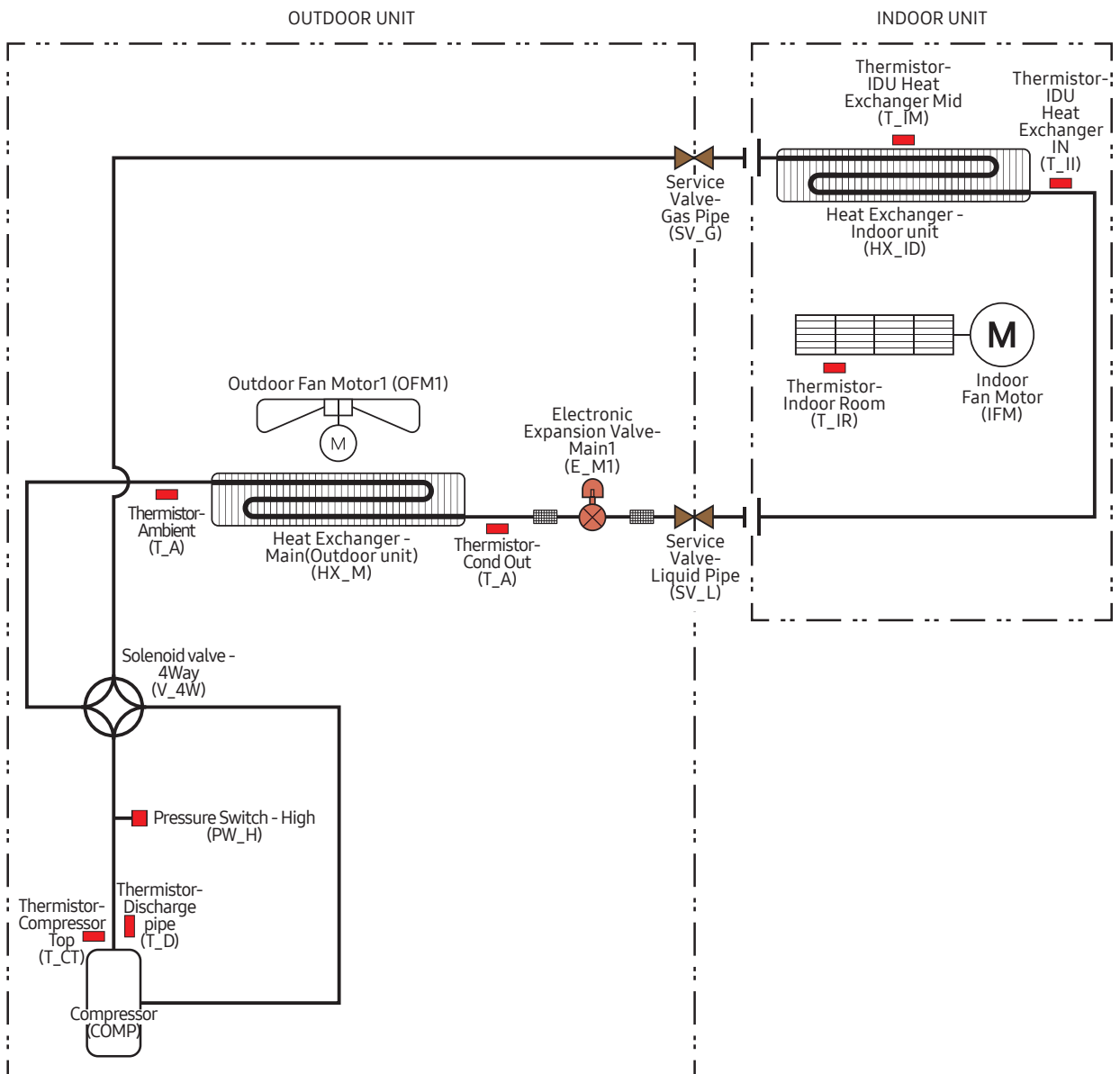



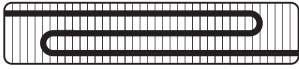





Category	Symbol	Description
Compressor		Compressor
Heat Exchanger	 HX_M	Heat Exchanger - Main (Outdoor unit)
	 HX_ID	Heat Exchanger - Indoor unit
Filter		Filter
EEV	 E_M	Electronic Expansion valve - Main
Solenoid Valve	 V_4W	Solenoid valve - 4Way
Valve (etc)	 SV_G	Service Valve - Gas Pipe
	 SV_L	Service Valve - Liquid Pipe
Thermistor	 T_CT	Thermistor - Compressor Top
	 T_D	Thermistor - Discharge pipe
	 T_CO	Thermistor - Cond Out
	 T_A	Thermistor - Ambient
	 T_IR	Thermistor - Indoor Room
	 T_IM	Thermistor - IDU Heat Exchanger Mid
	 T_II	Thermistor - IDU Heat Exchanger In
Fan	 OFM1	Outdoor Fan Motor 1
	 IFM	Indoor Fan Motor
Pressure switch	 PW_H	Pressure Switch - High

# 8. Piping Diagram

AC026RN1DKG/EU+AC026RXADKG/EU  
 AC026RNADKG/EU+AC026RXADKG/EU  
 AC026TNXDKG/EU+AC026RXADKG/EU  
 AC035RN1DKG/EU+AC035RXADKG/EU  
 AC035RNADKG/EU+AC035RXADKG/EU  
 AC035TNXDKG/EU+AC035RXADKG/EU

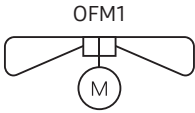
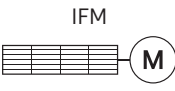

# 8. Piping Diagram







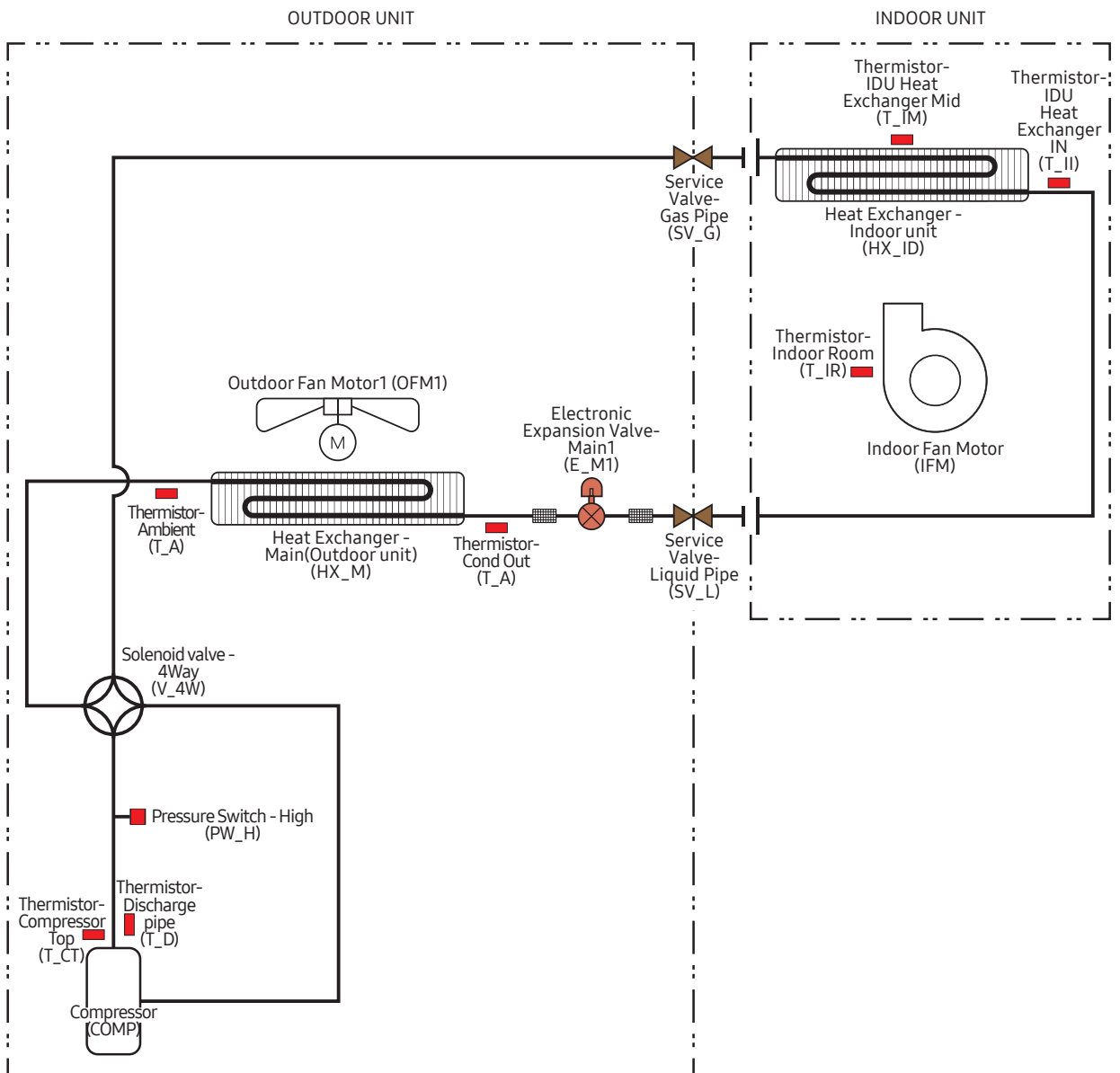









Category	Symbol	Description
Compressor		Compressor
Heat Exchanger	 HX_M	Heat Exchanger - Main (Outdoor unit)
	 HX_ID	Heat Exchanger - Indoor unit
Filter		Filter
EEV	 E_M	Electronic Expansion valve - Main
Solenoid Valve	 V_4W	Solenoid valve - 4Way
Valve (etc)	 SV_G	Service Valve - Gas Pipe
	 SV_L	Service Valve - Liquid Pipe
Thermistor	 T_CT	Thermistor - Compressor Top
	 T_D	Thermistor - Discharge pipe
	 T_CO	Thermistor - Cond Out
	 T_A	Thermistor - Ambient
	 T_IR	Thermistor - Indoor Room
	 T_IM	Thermistor - IDU Heat Exchanger Mid
	 T_II	Thermistor - IDU Heat Exchanger In
Fan	 OFM1	Outdoor Fan Motor 1
	 IFM	Indoor Fan Motor
Pressure switch	 PW_H	Pressure Switch - High

# 8. Piping Diagram

AC026RNLDKG/EU+AC026RXADKG/EU  
 AC035RNLDKG/EU+AC035RXADKG/EU  
 AC035RNMDKG/EU+AC035RXADKG/EU

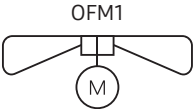

# 8. Piping Diagram







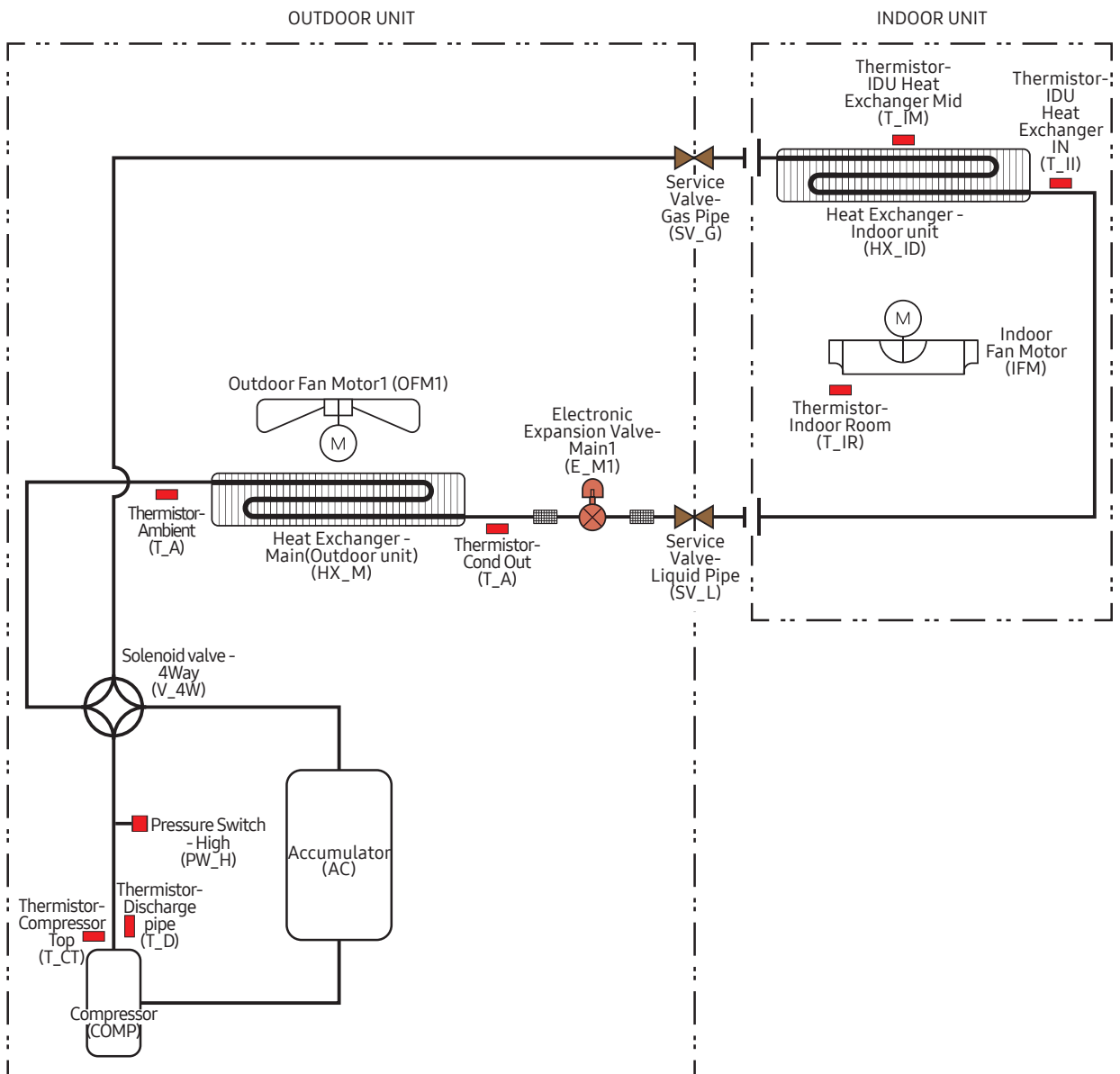



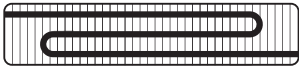
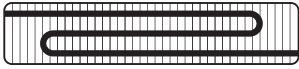





Category	Symbol	Description
Compressor		Compressor
Heat Exchanger	 HX_M	Heat Exchanger - Main (Outdoor unit)
	 HX_ID	Heat Exchanger - Indoor unit
Filter		Filter
EEV	 E_M	Electronic Expansion valve - Main
Solenoid Valve	 V_4W	Solenoid valve - 4Way
Valve (etc)	 SV_G	Service Valve - Gas Pipe
	 SV_L	Service Valve - Liquid Pipe
Thermistor	 T_CT	Thermistor - Compressor Top
	 T_D	Thermistor - Discharge pipe
	 T_CO	Thermistor - Cond Out
	 T_A	Thermistor - Ambient
	 T_IR	Thermistor - Indoor Room
	 T_IM	Thermistor - IDU Heat Exchanger Mid
	 T_II	Thermistor - IDU Heat Exchanger In
Fan	 OFM1	Outdoor Fan Motor 1
	 IFM	Indoor Fan Motor
Pressure switch	 PW_H	Pressure Switch - High

# 8. Piping Diagram

AC052RNNDKG/EU+AC052RXADKG/EU  
 AC052RN4DKG/EU+AC052MXADKG/EU  
 AC052RNJDKG/EU+AC052RXADKG/EU  
 AC071RNNDKG/EU+AC071MXADKG/EU  
 AC071RN4DKG/EU+AC071MXADKG/EU  
 AC071RN4PKG/EU+AC071MXADKG/EU

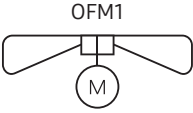
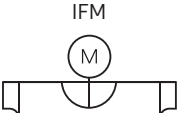

# 8. Piping Diagram

Category	Symbol	Description
Compressor		Compressor
Heat Exchanger	 HX_M	Heat Exchanger - Main (Outdoor unit)
	 HX_ID	Heat Exchanger - Indoor unit
Tank		Accumulator
Filter		Filter
EEV	 E_M	Electronic Expansion valve - Main
Solenoid Valve	 V_4W	Solenoid valve - 4Way
Valve (etc)	 SV_G	Service Valve - Gas Pipe
	 SV_L	Service Valve - Liquid Pipe
Thermistor	 T_CT	Thermistor - Compressor Top
	 T_D	Thermistor - Discharge pipe
	 T_CO	Thermistor - Cond Out
	 T_A	Thermistor - Ambient
	 T_IR	Thermistor - Indoor Room
	 T_IM	Thermistor - IDU Heat Exchanger Mid
	 T_II	Thermistor - IDU Heat Exchanger In
Fan	 OFM1	Outdoor Fan Motor 1
	 IFM	Indoor Fan Motor
Pressure switch	 PW_H	Pressure Switch - High





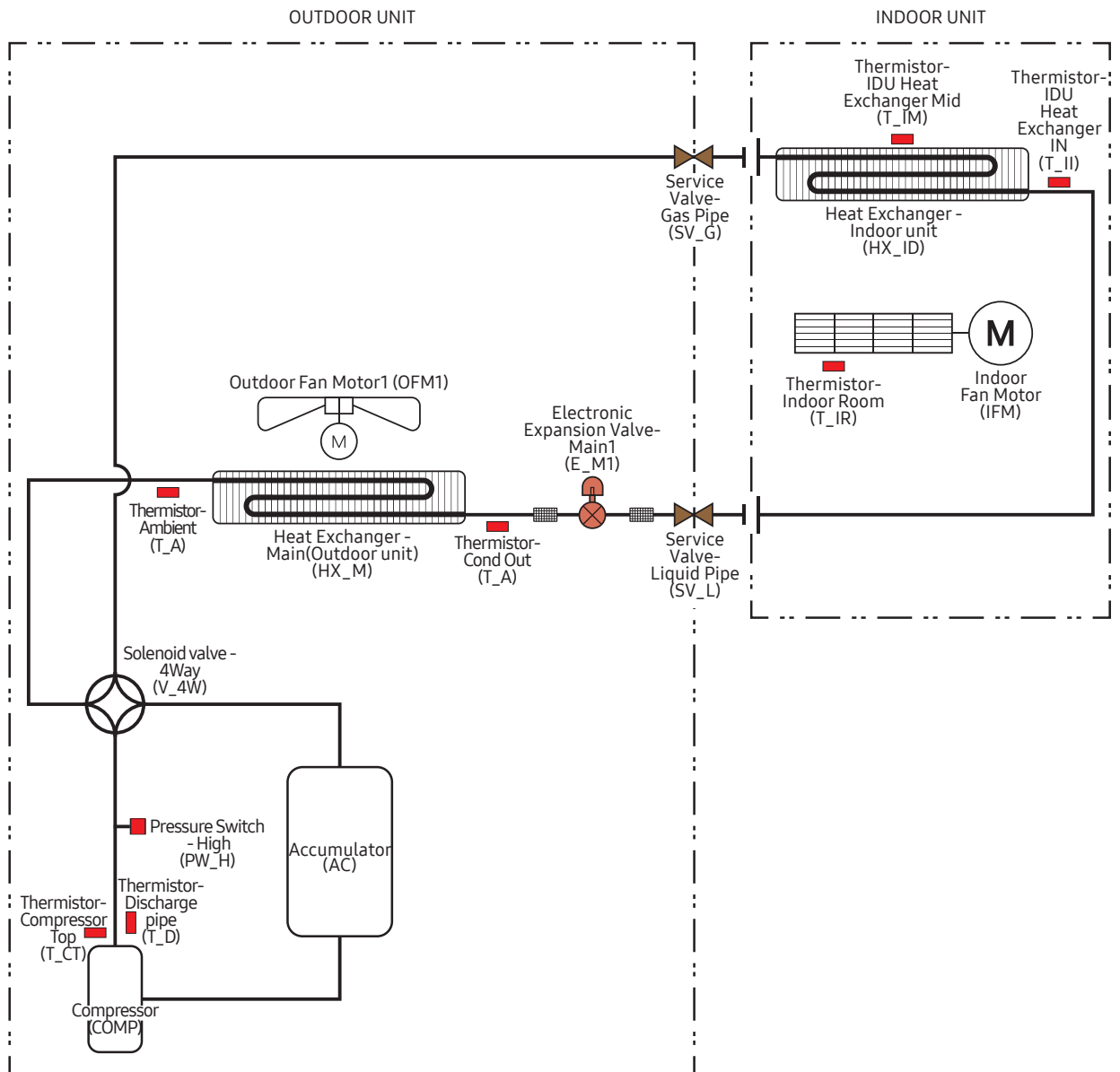





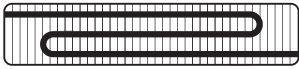
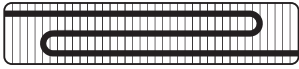





# 8. Piping Diagram

AC052RNADKG/EU+AC052RXADKG/EU  
 AC052TNXDKG/EU+AC052RXADKG/EU  
 AC071RNADKG/EU+AC071RXADKG/EU  
 AC071TNXDKG/EU+AC071RXADKG/EU



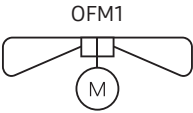
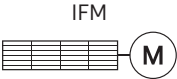

# 8. Piping Diagram







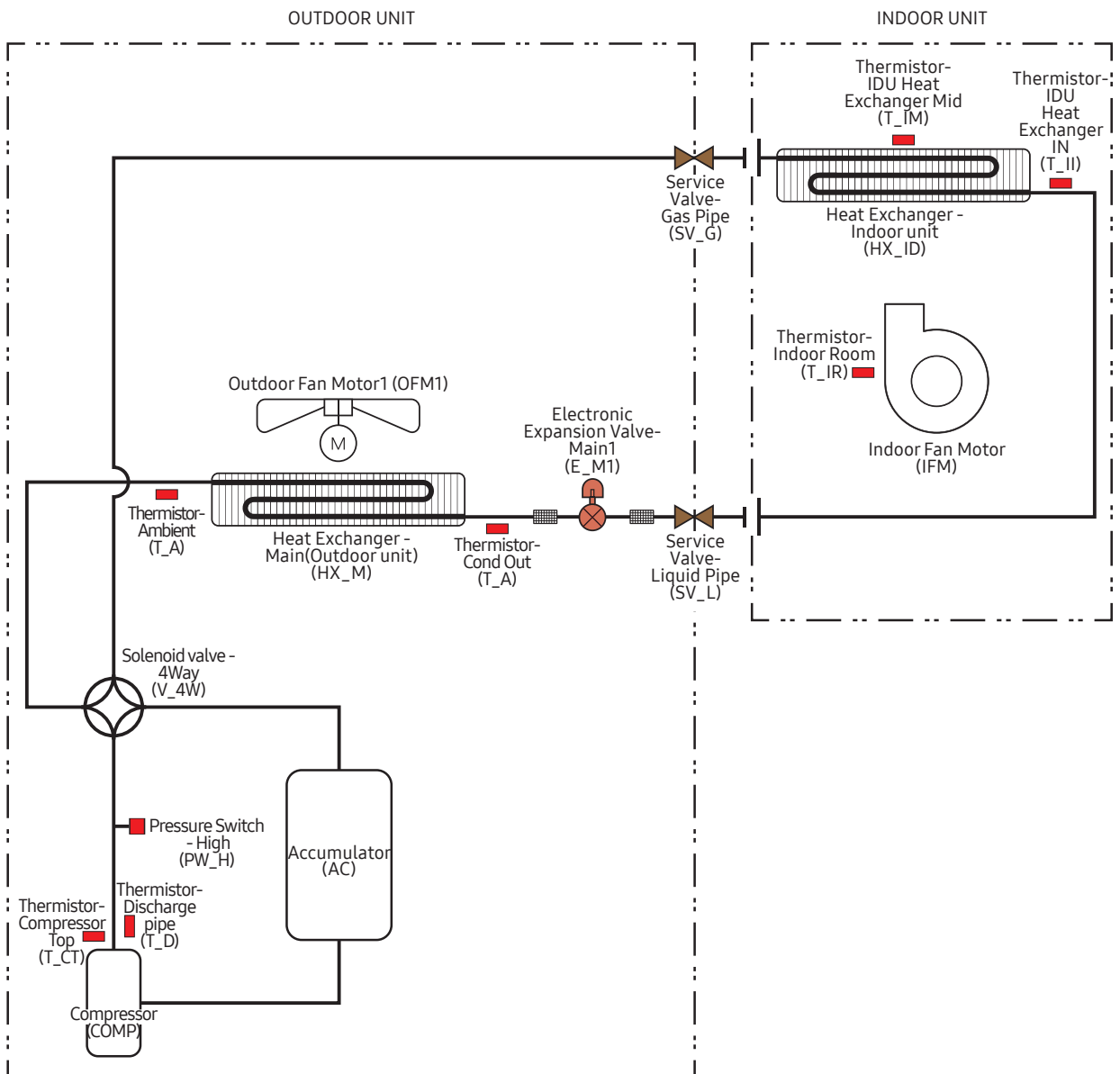



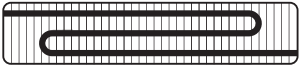





Category	Symbol	Description
Compressor		Compressor
Heat Exchanger	 HX_M	Heat Exchanger - Main (Outdoor unit)
	 HX_ID	Heat Exchanger - Indoor unit
Tank		Accumulator
Filter		Filter
EEV	 E_M	Electronic Expansion valve - Main
Solenoid Valve	 V_4W	Solenoid valve - 4Way
Valve (etc)	 SV_G	Service Valve - Gas Pipe
	 SV_L	Service Valve - Liquid Pipe
Thermistor	 T_CT	Thermistor - Compressor Top
	 T_D	Thermistor - Discharge pipe
	 T_CO	Thermistor - Cond Out
	 T_A	Thermistor - Ambient
	 T_IR	Thermistor - Indoor Room
	 T_IM	Thermistor - IDU Heat Exchanger Mid
	 T_II	Thermistor - IDU Heat Exchanger In
Fan	 OFM1	Outdoor Fan Motor1
	 IFM	Indoor Fan Motor
Pressure switch	 PW_H	Pressure Switch - High

# 8. Piping Diagram

AC052RNCDKG/EU+AC052RXADKG/EU  
 AC052RNMDKG/EU+AC052RXADKG/EU  
 AC052RNLDKG/EU+AC052RXADKG/EU  
 AC071RNCDKG/EU+AC071RXADKG/EU  
 AC071RNMDKG/EU+AC071RXADKG/EU  
 AC071RNLDKG/EU+AC071RXADKG/EU

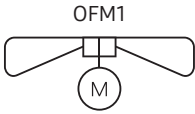

# 8. Piping Diagram







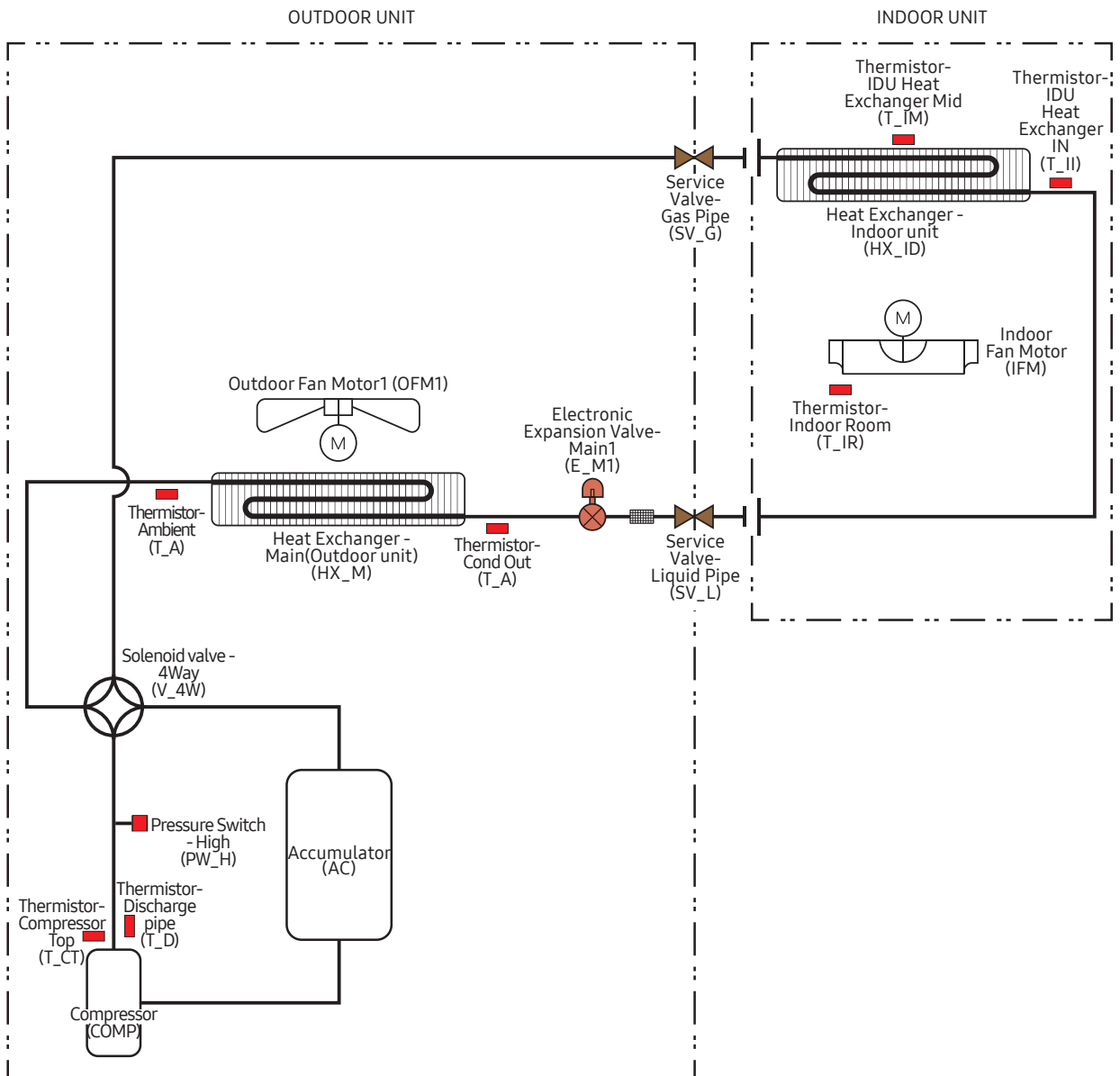











Category	Symbol	Description
Compressor		Compressor
Heat Exchanger	 HX_M	Heat Exchanger - Main (Outdoor unit)
	 HX_ID	Heat Exchanger - Indoor unit
Tank		Accumulator
Filter		Filter
EEV	 E_M	Electronic Expansion valve - Main
Solenoid Valve	 V_4W	Solenoid valve - 4Way
Valve (etc)	 SV_G	Service Valve - Gas Pipe
	 SV_L	Service Valve - Liquid Pipe
Thermistor	 T_CT	Thermistor - Compressor Top
	 T_D	Thermistor - Discharge pipe
	 T_CO	Thermistor - Cond Out
	 T_A	Thermistor - Ambient
	 T_IR	Thermistor - Indoor Room
	 T_IM	Thermistor - IDU Heat Exchanger Mid
	 T_II	Thermistor - IDU Heat Exchanger In
Fan	 OFM1	Outdoor Fan Motor1
	 IFM	Indoor Fan Motor
Pressure switch	 PW_H	Pressure Switch - High

# 8. Piping Diagram

AC100RN4DKG/EU+AC100RXADKG/EU, AC100RN4DKG/EU+AC100RXADNG/EU  
 AC100RN4PKG/EU+AC100RXADKG/EU, AC100RN4PKG/EU+AC100RXADNG/EU  
 AC120RN4DKG/EU+AC120RXADKG/EU, AC120RN4DKG/EU+AC120RXADNG/EU  
 AC120RN4PKG/EU+AC120RXADKG/EU, AC120RN4PKG/EU+AC120RXADNG/EU

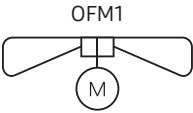
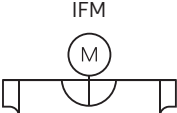

# 8. Piping Diagram







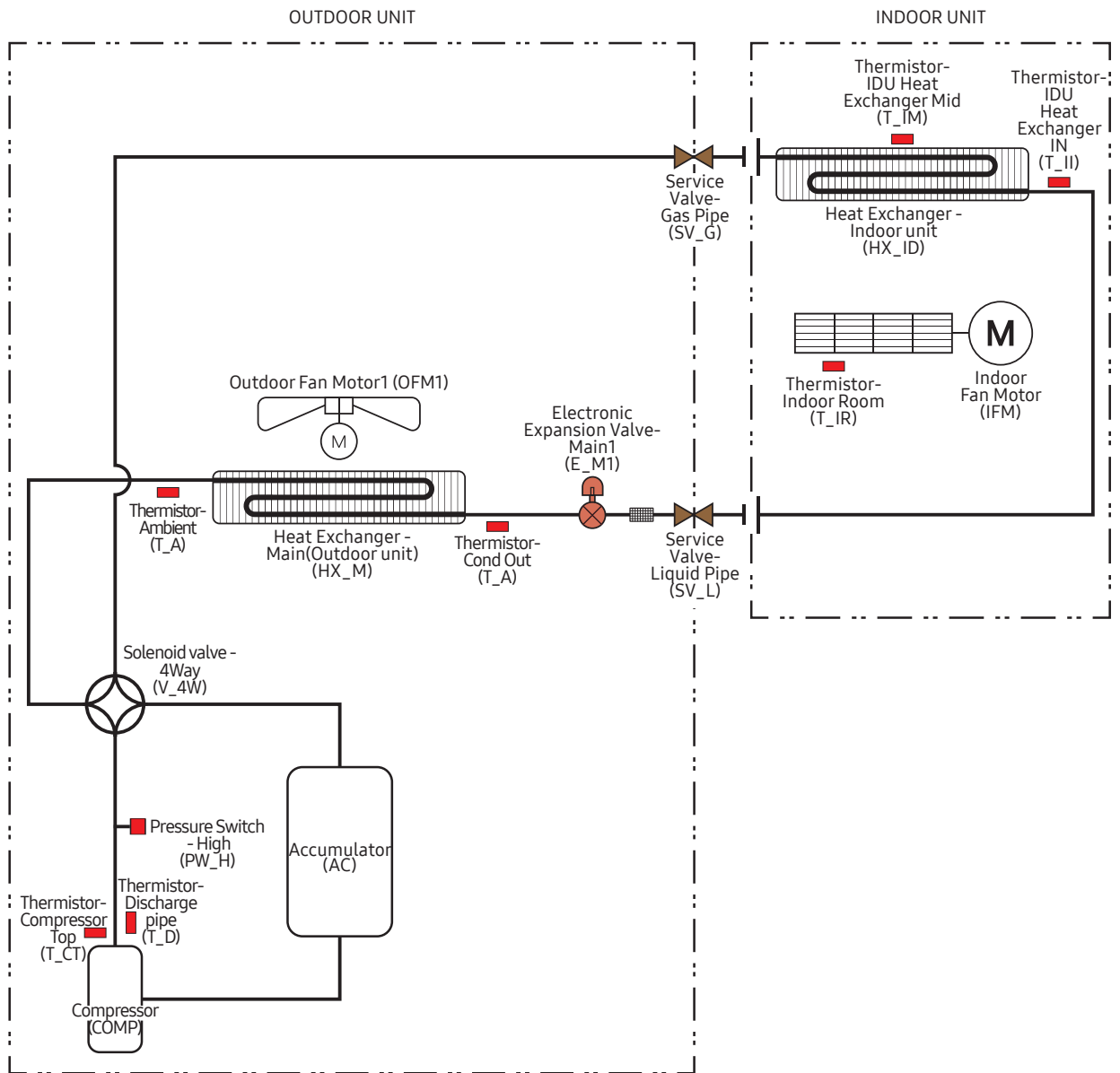





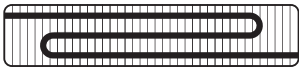





Category	Symbol	Description
Compressor		Compressor
Heat Exchanger	 HX_M	Heat Exchanger - Main (Outdoor unit)
	 HX_ID	Heat Exchanger - Indoor unit
Tank		Accumulator
Filter		Filter
EEV	 E_M	Electronic Expansion valve - Main
Solenoid Valve	 V_4W	Solenoid valve - 4Way
Valve (etc)	 SV_G	Service Valve - Gas Pipe
	 SV_L	Service Valve - Liquid Pipe
Thermistor	 T_CT	Thermistor - Compressor Top
	 T_D	Thermistor - Discharge pipe
	 T_CO	Thermistor - Cond Out
	 T_A	Thermistor - Ambient
	 T_IR	Thermistor - Indoor Room
	 T_IM	Thermistor - IDU Heat Exchanger Mid
	 T_II	Thermistor - IDU Heat Exchanger In
Fan	 OFM1	Outdoor Fan Motor1
	 IFM	Indoor Fan Motor
Pressure switch	 PW_H	Pressure Switch - High

# 8. Piping Diagram

AC100RNTDKG/EU+AC100RXADKG/EU, AC100RNTDKG/EU+AC100RXADNG/EU

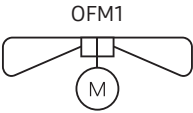

# 8. Piping Diagram

Category	Symbol	Description
Compressor		Compressor
Heat Exchanger	 HX_M	Heat Exchanger - Main (Outdoor unit)
	 HX_ID	Heat Exchanger - Indoor unit
Tank		Accumulator
Filter		Filter
EEV	 E_M	Electronic Expansion valve - Main
Solenoid Valve	 V_4W	Solenoid valve - 4Way
Valve (etc)	 SV_G	Service Valve - Gas Pipe
	 SV_L	Service Valve - Liquid Pipe
Thermistor	 T_CT	Thermistor - Compressor Top
	 T_D	Thermistor - Discharge pipe
	 T_CO	Thermistor - Cond Out
	 T_A	Thermistor - Ambient
	 T_IR	Thermistor - Indoor Room
	 T_IM	Thermistor - IDU Heat Exchanger Mid
	 T_II	Thermistor - IDU Heat Exchanger In
Fan	 OFM1	Outdoor Fan Motor1
	 IFM	Indoor Fan Motor
Pressure switch	 PW_H	Pressure Switch - High





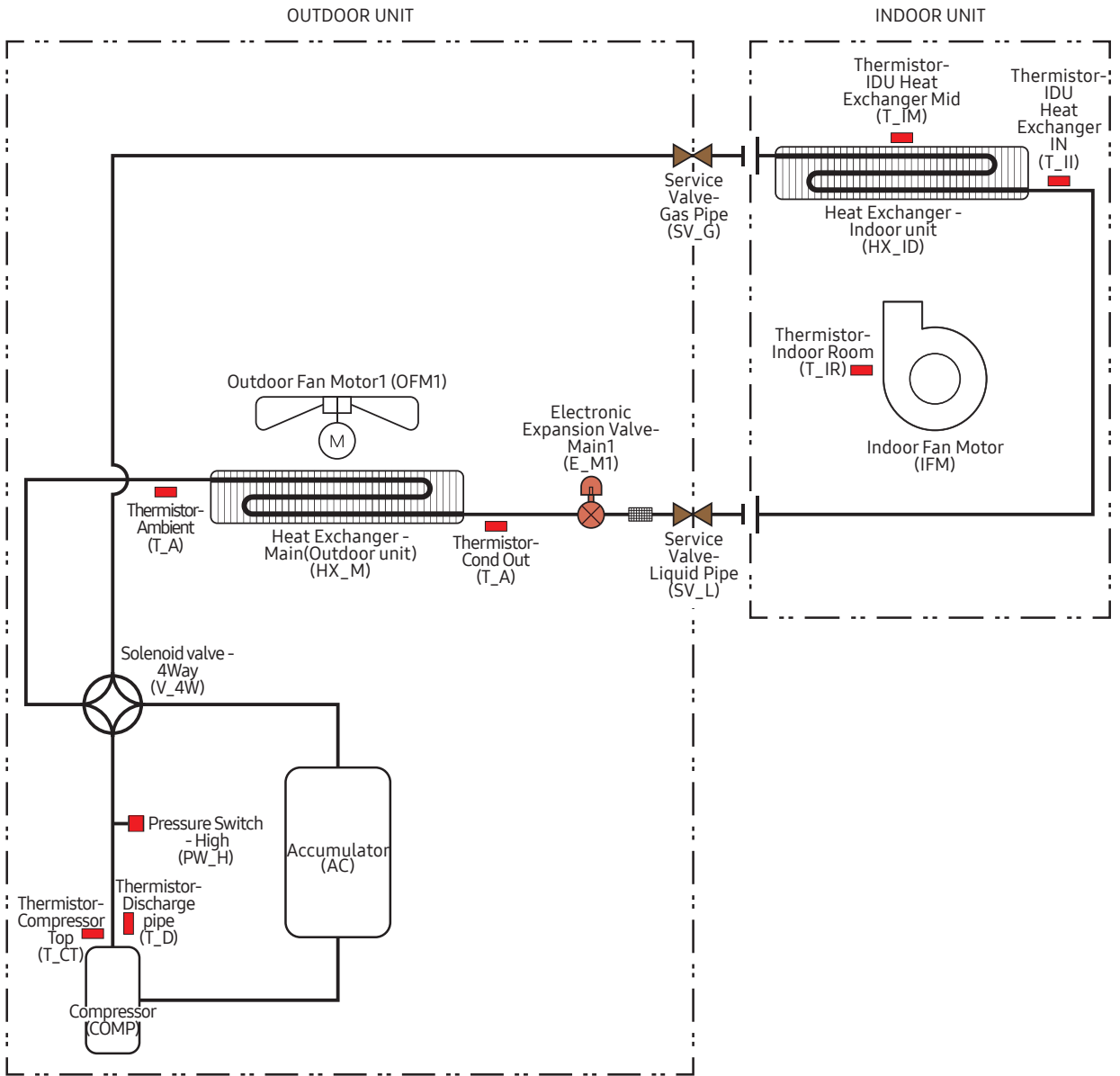





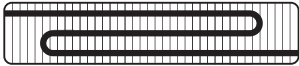





# 8. Piping Diagram

AC100RNMDKG/EU+AC100RXADKG/EU, AC100RNMDKG/EU+AC100RXADNG/EU  
 AC100RNCDKG/EU+AC100RXADKG/EU, AC100RNCDKG/EU+AC100RXADNG/EU  
 AC120RNMDKG/EU+AC120RXADKG/EU, AC120RNMDKG/EU+AC120RXADNG/EU  
 AC120RNCDKG/EU+AC120RXADKG/EU, AC120RNCDKG/EU+AC120RXADNG/EU



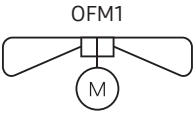

# 8. Piping Diagram







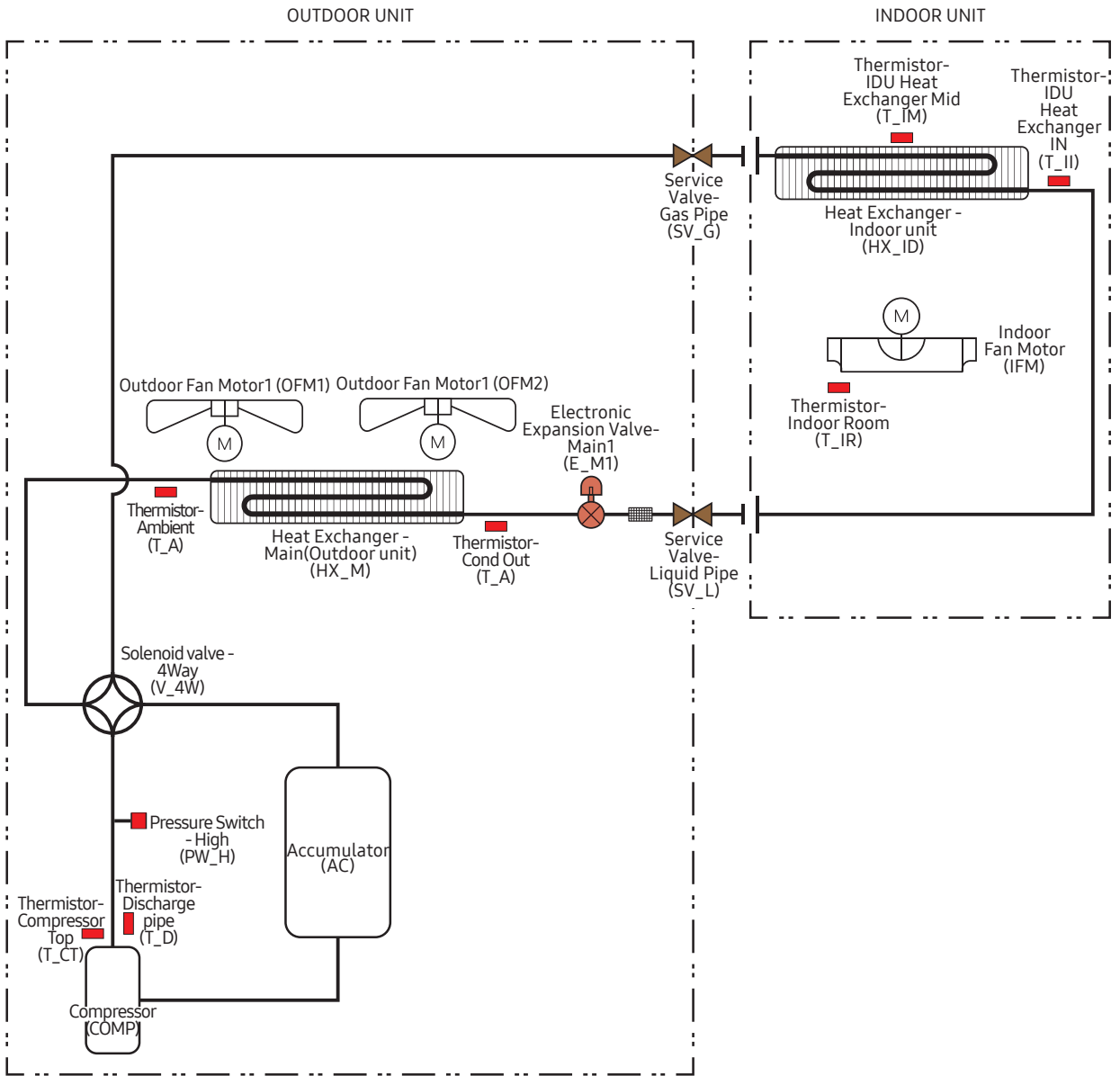











Category	Symbol	Description
Compressor		Compressor
Heat Exchanger	 HX_M	Heat Exchanger - Main (Outdoor unit)
	 HX_ID	Heat Exchanger - Indoor unit
Tank		Accumulator
Filter		Filter
EEV	 E_M	Electronic Expansion valve - Main
Solenoid Valve	 V_4W	Solenoid valve - 4Way
Valve (etc)	 SV_G	Service Valve - Gas Pipe
	 SV_L	Service Valve - Liquid Pipe
Thermistor	 T_CT	Thermistor - Compressor Top
	 T_D	Thermistor - Discharge pipe
	 T_CO	Thermistor - Cond Out
	 T_A	Thermistor - Ambient
	 T_IR	Thermistor - Indoor Room
	 T_IM	Thermistor - IDU Heat Exchanger Mid
	 T_II	Thermistor - IDU Heat Exchanger In
Fan	 OFM1	Outdoor Fan Motor1
	 IFM	Indoor Fan Motor
Pressure switch	 PW_H	Pressure Switch - High

# 8. Piping Diagram

AC100RN4DKG/EU+AC100RXADKG/EU, AC100RN4DKG/EU+AC100RXADNG/EU  
 AC100RN4PKG/EU+AC100RXADKG/EU, AC100RN4PKG/EU+AC100RXADNG/EU  
 AC120RN4DKG/EU+AC120RXADKG/EU, AC120RN4DKG/EU+AC120RXADNG/EU  
 AC120RN4PKG/EU+AC120RXADKG/EU, AC120RN4PKG/EU+AC120RXADNG/EU

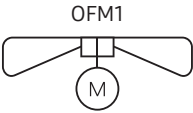
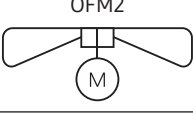
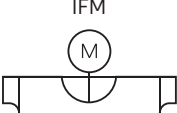

# 8. Piping Diagram







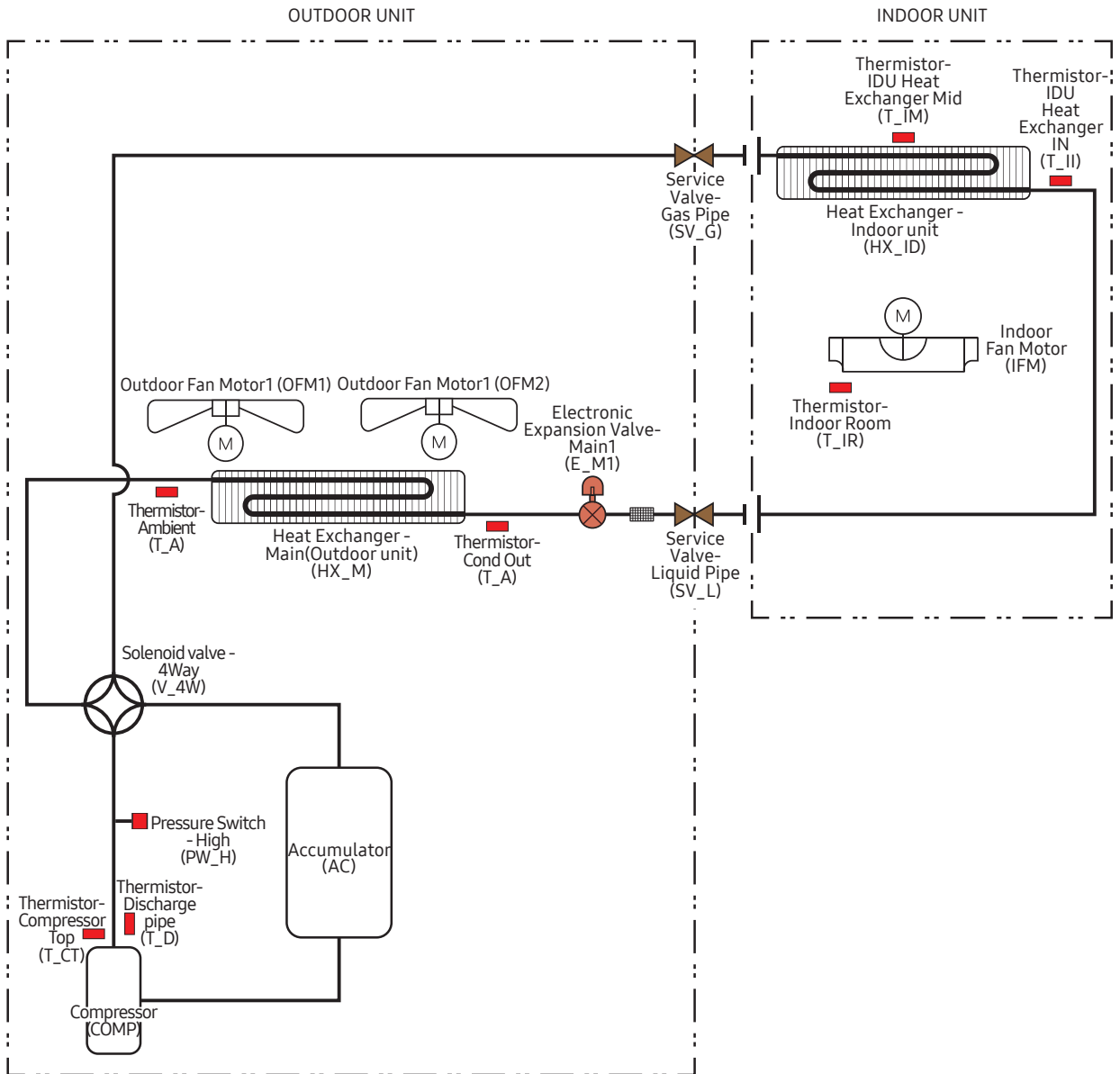



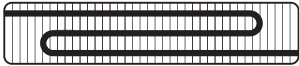





Category	Symbol	Description
Compressor		Compressor
Heat Exchanger	 HX_M	Heat Exchanger - Main (Outdoor unit)
	 HX_ID	Heat Exchanger - Indoor unit
Tank		Accumulator
Filter		Filter
EEV	 E_M	Electronic Expansion valve - Main
Solenoid Valve	 V_4W	Solenoid valve - 4Way
Valve (etc)	 SV_G	Service Valve - Gas Pipe
	 SV_L	Service Valve - Liquid Pipe
Thermistor	 T_CT	Thermistor - Compressor Top
	 T_D	Thermistor - Discharge pipe
	 T_CO	Thermistor - Cond Out
	 T_A	Thermistor - Ambient
	 T_IR	Thermistor - Indoor Room
	 T_IM	Thermistor - IDU Heat Exchanger Mid
	 T_II	Thermistor - IDU Heat Exchanger In
Fan	 OFM1	Outdoor Fan Motor 1
	 OFM2	Outdoor Fan Motor 2
	 IFM	Indoor Fan Motor
Pressure switch	 PW_H	Pressure Switch - High

# 8. Piping Diagram

AC140RN4DKG/EU+AC140RXADKG/EU, AC140RN4DKG/EU+AC140RXADNG/EU  
 AC140RN4PKG/EU+AC140RXADKG/EU, AC140RN4PKG/EU+AC140RXADNG/EU

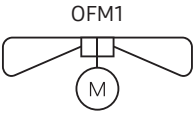
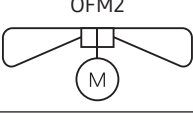
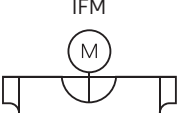

# 8. Piping Diagram

Category	Symbol	Description
Compressor		Compressor
Heat Exchanger	 HX_M	Heat Exchanger - Main (Outdoor unit)
	 HX_ID	Heat Exchanger - Indoor unit
Tank		Accumulator
Filter		Filter
EEV	 E_M	Electronic Expansion valve - Main
Solenoid Valve	 V_4W	Solenoid valve - 4Way
Valve (etc)	 SV_G	Service Valve - Gas Pipe
	 SV_L	Service Valve - Liquid Pipe
Thermistor	 T_CT	Thermistor - Compressor Top
	 T_D	Thermistor - Discharge pipe
	 T_CO	Thermistor - Cond Out
	 T_A	Thermistor - Ambient
	 T_IR	Thermistor - Indoor Room
	 T_IM	Thermistor - IDU Heat Exchanger Mid
	 T_II	Thermistor - IDU Heat Exchanger In
Fan	 OFM1	Outdoor Fan Motor 1
	 OFM2	Outdoor Fan Motor 2
	 IFM	Indoor Fan Motor
Pressure switch	 PW_H	Pressure Switch - High

# 8. Piping Diagram

AC140RNMDKG/EU+AC140RXADKG/EU, AC140RNMDKG/EU+AC140RXADNG/EU  
 AC140RNC DKG/EU+AC140RXADKG/EU, AC140RNC DKG/EU+AC140RXADNG/EU

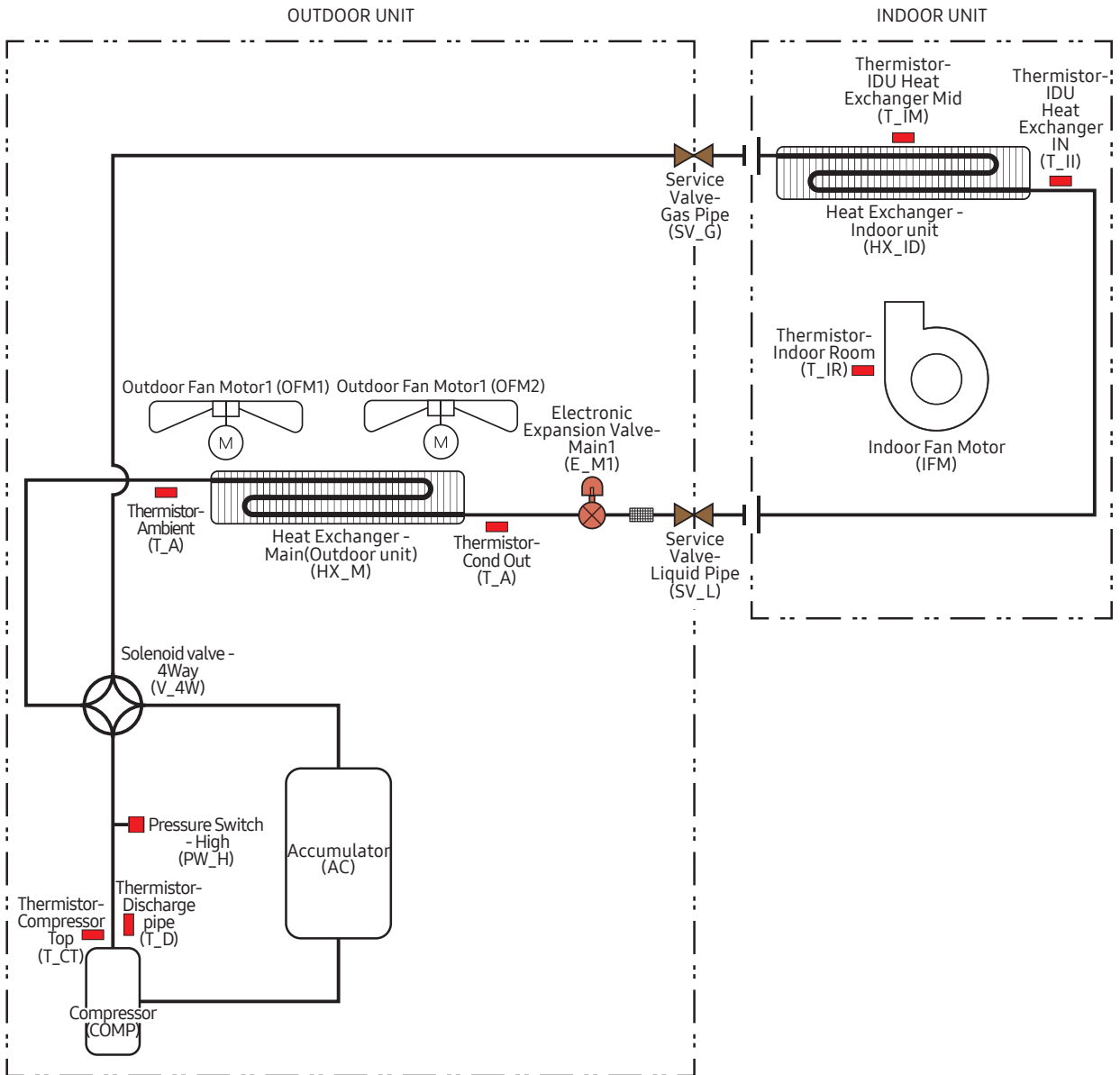

# 8. Piping Diagram

Category	Symbol	Description
Compressor		Compressor
Heat Exchanger	 HX_M	Heat Exchanger - Main (Outdoor unit)
	 HX_ID	Heat Exchanger - Indoor unit
Tank		Accumulator
Filter		Filter
EEV	 E_M	Electronic Expansion valve - Main
Solenoid Valve	 V_4W	Solenoid valve - 4Way
Valve (etc)	 SV_G	Service Valve - Gas Pipe
	 SV_L	Service Valve - Liquid Pipe
Thermistor	 T_CT	Thermistor - Compressor Top
	 T_D	Thermistor - Discharge pipe
	 T_CO	Thermistor - Cond Out
	 T_A	Thermistor - Ambient
	 T_IR	Thermistor - Indoor Room
	 T_IM	Thermistor - IDU Heat Exchanger Mid
	 T_II	Thermistor - IDU Heat Exchanger In
Fan	 OFM1	Outdoor Fan Motor 1
	 OFM2	Outdoor Fan Motor 2
	 IFM	Indoor Fan Motor
Pressure switch	 PW_H	Pressure Switch - High