

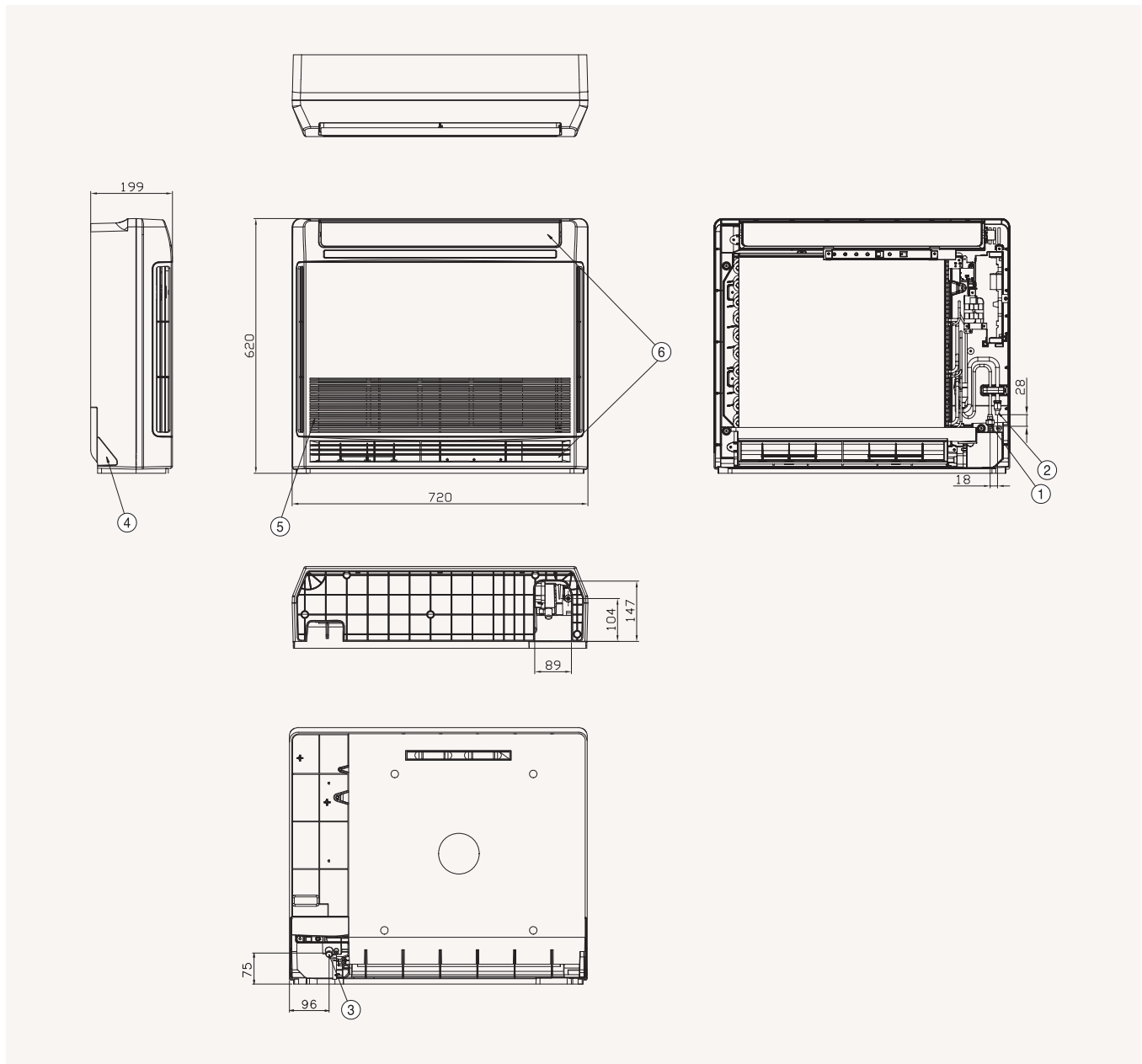

# Dimensional drawings

## Console

AM022/045KNJDEH/EU, AM028/036FNJDEH/EU



NO	Name	Description
1	Liquid pipe connection	ø6.35 Flare
2	Gas pipe connection	ø12.70 Flare
3	Drain pipe connection	ID 18 Hose
4	Power supply/communication wiring conduits	
5	Air inlet grille	
6	Air outlet louvre	



# Console

- 1 *Specifications*
- 2 *Capacity Table*
- 3 *Dimensional Drawing*
- 4 *Electrical Wiring Diagram*
- 5 *Sound Pressure Level*
- 6 *Sound Power Level*
- 7 *Temperature and air flow distribution*

# 1 Specifications

## Console

Type			Console		Console		
Model			AM022KNJDEH/EU		AM045KNJDEH/EU		
Power Supply		Ø, #, V, Hz	1,2,220-240,50		1,2,220-240,50		
Mode			HP/HR		HP/HR		
Performance	Capacity (Nominal)	Cooling	kW	2.20	4.50		
			Btu/h	7,500	15,400		
		Heating	kW	2.50	5.00		
			Btu/h	8,500	17,100		
Power	Power Input (Nominal)	Cooling	W	16.00	36.00		
		Heating	W	16.00	36.00		
	Current Input (Nominal)	Cooling	A	0.13	0.30		
		Heating	A	0.13	0.30		
Fan	Motor	Type	-	Turbo Fan			
		Output x n	w	37 x 1			
	Air Flow Rate	H/M/L (UL)	CMM	6.30 / 5.40 / 4.90			
			l/s	105.00 / 90.00 / 81.67			
	External Pressure	Min/Std/Max	mmAq	-			
Pa			-				
Piping Connections	Liquid Pipe	Ø, mm	6.35				
		Ø, inch	1/4"				
	Gas Pipe	Ø, mm	12.70				
		Ø, inch	1/2"				
Drain Pipe	Ø, mm	ID18 HOSE					
Field Wiring	Power Source Wire	mm <sup>2</sup>	1.5 - 2.5				
	Transmission Cable	mm <sup>2</sup>	0.75 - 1.50				
Refrigerant	Type	-	R410A				
	Control Method	-	EEV INCLUDED				
Sound	Pressure	High / Mid / Low	dB(A)	34 / 32 / 30			
	Power	Cooling		52			
Dimension	Net Weight		kg	15.50	16.00		
	Shipping Weight		kg	20.50	21.00		
	Net Dimensions (WxHxD)		mm	720 x 620 x 199		720 x 620 x 199	
	Shipping Dimensions (WxHxD)		mm	810 x 710 x 295		810 x 710 x 295	
Panel Size	Panel model		-	-			
	Panel Net Weight		kg	-			
	Shipping Weight		kg	-			
	Net Dimensions (WxHxD)		mm	-			
	Shipping Dimensions (WxHxD)		mm	-			
Additional Accessories	Drain Pump	Drain Pump	- / Model	-			
		Max. lifting Height / Displacement	mm/liter/h	-			
	Air Filter		-	-			

### NOTE

- 1) Mode : HP(Heat Pump), HR(Heat Recovery)
  - 2) Nominal Cooling : Indoor temperature 27°CDB / 19°CWB, Outdoor temperature 35°CDB/24°CWB, Refrigerant pipe length 7.5m, Level difference 0m.
  - 3) Nominal Heating : Indoor temperature 20°CDB / 15°CWB, Outdoor temperature 7°CDB / 6°CWB, Refrigerant pipe length 7.5m, Level difference 0m.
  - 4) Sound level was acquired in an anechoic room. Thus actual noise level may be different depending on the installation conditions.
  - 5) These products contain R410A which is fluorinated greenhouse gas.
  - 6) Specifications may be subject to change without prior notice.
- \* Heat Exchanger type : Fin & Tube (Fin : Al, Tube : Cu)

# 1 Specifications

## Console

Model				AM028FNJDEH/EU	AM036FNJDEH/EU	AM056FNJDEH/EU
Power Supply		Ø, #, V, Hz		1, 2, 220~240, 50	1, 2, 220~240, 50	1, 2, 220~240, 50
Mode				HP/HR	HP/HR	HP/HR
Performance	Capacity (Nominal)	Cooling	kW	2.8	3.6	5.6
			Btu/h	9,600	12,300	19,100
		Heating	kW	3.2	4.0	6.3
			Btu/h	10,900	13,600	21,500
Power	Power Input (Nominal)	Cooling	W	30	35	62
		Heating	W	30	35	62
	Current Input (Nominal)	Cooling	A	0.25	0.29	0.49
		Heating	A	0.25	0.29	0.49
Fan	Motor	Type	-	Turbo Fan	Turbo Fan	Turbo Fan
		Output	W	37	37	37
		Number of unit	EA	1	1	1
	Air Flow Rate	H/M/L (UL)	CMM	7.00/6.00/5.00	8.50/7.50/6.50	13.00/11.50/10.00
			l/s	116.67/100.00/83.33	141.67/125.00/108.33	216.67/191.67/166.67
	External Pressure	Min / Std / Max	mmAq	-	-	-
			Pa	-	-	-
WG			-	-	-	
Option Code				019044-1950B7-201C1C-330010	019044-1950D7-202424-330010	019044-19541B-203838-330010
Piping Connections	Liquid Pipe	Ø, mm	6.35	6.35	6.35	
		Ø, inch	1/4	1/4	1/4	
	Gas Pipe	Ø, mm	12.70	12.70	12.70	
		Ø, inch	1/2	1/2	1/2	
Drain Pipe	Ø, mm	ID 18 HOSE	ID 18 HOSE	ID 18 HOSE		
Field Wiring	Power Source Wire	Below 20m / over 20m	mm <sup>2</sup>	1.5 / 2.5	1.5 / 2.5	1.5 / 2.5
	Transmission Cable		mm <sup>2</sup>	0.75~1.5	0.75~1.5	0.75~1.5
Refrigerant	Type		-	R410A	R410A	R410A
	Control Method		-	EEV INCLUDED	EEV INCLUDED	EEV INCLUDED
Sound	Sound Pressure	High / Mid / Low	dBA	38 / 36 / 34	39 / 37 / 34	43 / 40 / 37
	Sound Power		dBA	58	59	64
Dimensions	Net Weight		kg	16.00	16.00	16.00
	Shipping Weight		kg	21.00	21.00	21.00
	Net Dimensions (WxHxD)		mm	720 x 620 x 199	720 x 620 x 199	720 x 620 x 199
	Shipping Dimensions (WxHxD)		mm	810 x 710 x 295	810 x 710 x 295	810 x 710 x 295
Panel Size	Panel model		-	-	-	-
	Panel Net Weight		kg	-	-	-
	Shipping Weight		kg	-	-	-
	Net Dimensions (WxHxD)		mm	-	-	-
	Shipping Dimensions (WxHxD)		mm	-	-	-
Additional Accessories	Drain pump	Drain pump	- / Model	-	-	-
		Max. lifting Height / Displacement	mm/liter/h	-	-	-
	Air Filter				Long life filter	Long life filter

### NOTE

- 1) Mode : HP(Heat Pump), HR(Heat Recovery)
  - 2) Nominal Cooling : Indoor temperature 27°CDB / 19°CWB, Outdoor temperature 35°CDB/24°CWB, Refrigerant pipe length 7.5m, Level difference 0m.
  - 3) Nominal Heating : Indoor temperature 20°CDB / 15°CWB, Outdoor temperature 7°CDB / 6°CWB, Refrigerant pipe length 7.5m, Level difference 0m.
  - 4) Sound level was acquired in an anechoic room. Thus actual noise level may be different depending on the installation conditions.
  - 5) These products contain R410A which is fluorinated greenhouse gas.
  - 6) Specifications may be subject to change without prior notice.
- \* Heat Exchanger type : Fin & Tube (Fin : Al, Tube : Cu)

# 2 Capacity Table

## Console

### Cooling

TC : Total Capacity(kW), SHC : Sensible Heat Capacity(kW)

Capacity Index	Outdoor Air Temp. (°C,DB)	Indoor temperature													
		20(°C,DB)		23(°C,DB)		26(°C,DB)		27(°C,DB)		28(°C,DB)		30(°C,DB)		32(°C,DB)	
		14(°C,WB)		16(°C,WB)		18(°C,WB)		19(°C,WB)		20(°C,WB)		22(°C,WB)		24(°C,WB)	
		TC	SHC	TC	SHC	TC	SHC	TC	SHC	TC	SHC	TC	SHC	TC	SHC
022	10	1.5	1.3	1.8	1.5	2.1	1.5	2.2	1.5	2.3	1.5	2.5	1.6	2.6	1.4
	12	1.5	1.3	1.8	1.5	2.1	1.5	2.2	1.5	2.3	1.5	2.5	1.6	2.6	1.4
	14	1.5	1.3	1.8	1.5	2.1	1.5	2.2	1.5	2.3	1.5	2.5	1.6	2.6	1.4
	16	1.5	1.3	1.8	1.5	2.1	1.5	2.2	1.5	2.3	1.5	2.4	1.5	2.6	1.4
	18	1.5	1.3	1.8	1.5	2.1	1.5	2.2	1.5	2.3	1.5	2.4	1.5	2.6	1.4
	20	1.5	1.3	1.8	1.5	2.1	1.5	2.2	1.5	2.3	1.5	2.4	1.5	2.6	1.4
	21	1.5	1.3	1.8	1.5	2.1	1.5	2.2	1.5	2.3	1.5	2.4	1.5	2.6	1.4
	23	1.5	1.3	1.8	1.5	2.1	1.5	2.2	1.5	2.3	1.5	2.4	1.5	2.6	1.4
	25	1.5	1.3	1.8	1.5	2.1	1.5	2.2	1.5	2.3	1.5	2.4	1.5	2.6	1.4
	27	1.5	1.3	1.8	1.5	2.1	1.5	2.2	1.5	2.3	1.5	2.4	1.5	2.6	1.4
	29	1.5	1.3	1.8	1.5	2.1	1.5	2.2	1.5	2.3	1.5	2.4	1.5	2.6	1.4
	31	1.5	1.3	1.8	1.5	2.1	1.5	2.2	1.5	2.3	1.5	2.4	1.5	2.6	1.4
	33	1.5	1.3	1.8	1.5	2.1	1.5	2.2	1.5	2.3	1.5	2.4	1.5	2.6	1.4
	35	1.5	1.3	1.8	1.5	2.1	1.5	2.2	1.5	2.3	1.5	2.4	1.5	2.6	1.4
	37	1.5	1.3	1.8	1.5	2.1	1.5	2.2	1.5	2.3	1.5	2.4	1.5	2.6	1.4
	39	1.5	1.3	1.8	1.5	2.1	1.5	2.2	1.5	2.3	1.5	2.4	1.5	2.5	1.3
42	1.5	1.3	1.8	1.5	2.1	1.5	2.2	1.5	2.3	1.5	2.4	1.5	2.4	1.3	
44	1.5	1.3	1.8	1.5	2.0	1.4	2.1	1.4	2.2	1.4	2.3	1.4	2.4	1.2	
46	1.5	1.3	1.8	1.5	2.0	1.4	2.0	1.4	2.1	1.4	2.2	1.4	2.3	1.2	
48	1.5	1.3	1.8	1.5	2.0	1.4	2.0	1.3	2.1	1.4	2.1	1.3	2.2	1.1	
028	10	1.9	1.6	2.3	1.8	2.6	2.0	2.8	1.9	2.9	1.9	3.1	1.9	3.4	1.9
	12	1.9	1.6	2.3	1.8	2.6	2.0	2.8	1.9	2.9	1.9	3.1	1.9	3.3	1.8
	14	1.9	1.6	2.3	1.8	2.6	2.0	2.8	1.9	2.9	1.9	3.1	1.9	3.3	1.8
	16	1.9	1.6	2.3	1.8	2.6	2.0	2.8	1.9	2.9	1.9	3.1	1.9	3.3	1.8
	18	1.9	1.6	2.3	1.8	2.6	2.0	2.8	1.9	2.9	1.9	3.1	1.9	3.3	1.8
	20	1.9	1.6	2.3	1.8	2.6	2.0	2.8	1.9	2.9	1.9	3.1	1.9	3.3	1.8
	21	1.9	1.6	2.3	1.8	2.6	2.0	2.8	1.9	2.9	1.9	3.1	1.9	3.3	1.8
	23	1.9	1.6	2.3	1.8	2.6	2.0	2.8	1.9	2.9	1.9	3.1	1.9	3.3	1.8
	25	1.9	1.6	2.3	1.8	2.6	2.0	2.8	1.9	2.9	1.9	3.1	1.9	3.3	1.8
	27	1.9	1.6	2.3	1.8	2.6	2.0	2.8	1.9	2.9	1.9	3.1	1.9	3.3	1.8
	29	1.9	1.6	2.3	1.8	2.6	2.0	2.8	1.9	2.9	1.9	3.1	1.9	3.3	1.8
	31	1.9	1.6	2.3	1.8	2.6	2.0	2.8	1.9	2.9	1.9	3.1	1.9	3.3	1.8
	33	1.9	1.6	2.3	1.8	2.6	2.0	2.8	1.9	2.9	1.9	3.1	1.9	3.3	1.8
	35	1.9	1.6	2.3	1.8	2.6	2.0	2.8	1.9	2.9	1.9	3.1	1.9	3.3	1.8
	37	1.9	1.6	2.3	1.8	2.6	2.0	2.8	1.9	2.9	1.9	3.1	1.9	3.3	1.8
	39	1.9	1.6	2.3	1.8	2.6	2.0	2.8	1.9	2.9	1.9	3.0	1.8	3.2	1.7
42	1.9	1.6	2.3	1.8	2.6	2.0	2.8	1.9	2.9	1.9	2.9	1.8	3.1	1.7	
44	1.9	1.6	2.3	1.8	2.5	1.9	2.7	1.8	2.8	1.8	2.8	1.7	3.0	1.6	
46	1.9	1.6	2.3	1.8	2.5	1.9	2.6	1.8	2.7	1.8	2.7	1.6	2.9	1.6	
48	1.9	1.6	2.2	1.8	2.4	1.9	2.5	1.7	2.6	1.7	2.7	1.6	2.8	1.5	
036	10	2.5	2.1	2.9	2.2	3.4	2.3	3.6	2.4	3.7	2.4	4.0	2.4	4.3	2.3
	12	2.5	2.1	2.9	2.2	3.4	2.3	3.6	2.4	3.7	2.4	4.0	2.4	4.3	2.3
	14	2.5	2.1	2.9	2.2	3.4	2.3	3.6	2.4	3.7	2.4	4.0	2.4	4.3	2.3
	16	2.5	2.1	2.9	2.2	3.4	2.3	3.6	2.4	3.7	2.4	4.0	2.4	4.3	2.3
	18	2.5	2.1	2.9	2.2	3.4	2.3	3.6	2.4	3.7	2.4	4.0	2.4	4.3	2.3
	20	2.5	2.1	2.9	2.2	3.4	2.3	3.6	2.4	3.7	2.4	4.0	2.4	4.2	2.3
	21	2.5	2.1	2.9	2.2	3.4	2.3	3.6	2.4	3.7	2.4	4.0	2.4	4.2	2.3
	23	2.5	2.1	2.9	2.2	3.4	2.3	3.6	2.4	3.7	2.4	4.0	2.4	4.2	2.3
	25	2.5	2.1	2.9	2.2	3.4	2.3	3.6	2.4	3.7	2.4	4.0	2.4	4.2	2.3
	27	2.5	2.1	2.9	2.2	3.4	2.3	3.6	2.4	3.7	2.4	4.0	2.4	4.2	2.3
	29	2.5	2.1	2.9	2.2	3.4	2.3	3.6	2.4	3.7	2.4	4.0	2.4	4.2	2.3
	31	2.5	2.1	2.9	2.2	3.4	2.3	3.6	2.4	3.7	2.4	4.0	2.4	4.2	2.3
	33	2.5	2.1	2.9	2.2	3.4	2.3	3.6	2.4	3.7	2.4	4.0	2.4	4.2	2.3
	35	2.5	2.1	2.9	2.2	3.4	2.3	3.6	2.4	3.7	2.4	4.0	2.4	4.2	2.3
	37	2.5	2.1	2.9	2.2	3.4	2.3	3.6	2.4	3.7	2.4	3.9	2.3	4.2	2.3
	39	2.5	2.1	2.9	2.2	3.4	2.3	3.6	2.4	3.7	2.4	3.9	2.3	4.1	2.2
42	2.5	2.1	2.9	2.2	3.4	2.3	3.6	2.4	3.7	2.4	3.8	2.3	4.0	2.1	
44	2.5	2.1	2.9	2.2	3.3	2.2	3.4	2.3	3.6	2.3	3.7	2.2	3.9	2.1	
46	2.5	2.1	2.9	2.2	3.2	2.2	3.3	2.2	3.4	2.2	3.6	2.1	3.8	2.0	
48	2.5	2.1	2.8	2.2	3.2	2.1	3.2	2.2	3.4	2.2	3.5	2.0	3.6	1.9	

# 2 Capacity Table

## Console

### Cooling

TC : Total Capacity(kW), SHC : Sensible Heat Capacity(kW)

Capacity Index	Outdoor Air Temp. (°C,DB)	Indoor temperature													
		20(°C,DB)		23(°C,DB)		26(°C,DB)		27(°C,DB)		28(°C,DB)		30(°C,DB)		32(°C,DB)	
		14(°C,WB)		16(°C,WB)		18(°C,WB)		19(°C,WB)		20(°C,WB)		22(°C,WB)		24(°C,WB)	
		TC	SHC	TC	SHC	TC	SHC	TC	SHC	TC	SHC	TC	SHC	TC	SHC
045	10	3.1	2.4	3.7	2.7	4.3	2.9	4.5	3.0	4.7	3.0	5.1	3.1	5.4	2.8
	12	3.1	2.4	3.7	2.7	4.3	2.9	4.5	3.0	4.7	3.0	5.1	3.1	5.4	2.8
	14	3.1	2.4	3.7	2.7	4.3	2.9	4.5	3.0	4.7	3.0	5.0	3.0	5.4	2.8
	16	3.1	2.4	3.7	2.7	4.3	2.9	4.5	3.0	4.7	3.0	5.0	3.0	5.3	2.8
	18	3.1	2.4	3.7	2.7	4.3	2.9	4.5	3.0	4.7	3.0	5.0	3.0	5.3	2.8
	20	3.1	2.4	3.7	2.7	4.3	2.9	4.5	3.0	4.7	3.0	5.0	3.0	5.3	2.8
	21	3.1	2.4	3.7	2.7	4.3	2.9	4.5	3.0	4.7	3.0	5.0	3.0	5.3	2.8
	23	3.1	2.4	3.7	2.7	4.3	2.9	4.5	3.0	4.7	3.0	5.0	3.0	5.3	2.8
	25	3.1	2.4	3.7	2.7	4.3	2.9	4.5	3.0	4.7	3.0	5.0	3.0	5.3	2.8
	27	3.1	2.4	3.7	2.7	4.3	2.9	4.5	3.0	4.7	3.0	5.0	3.0	5.3	2.8
	29	3.1	2.4	3.7	2.7	4.3	2.9	4.5	3.0	4.7	3.0	5.0	3.0	5.3	2.8
	31	3.1	2.4	3.7	2.7	4.3	2.9	4.5	3.0	4.7	3.0	5.0	3.0	5.3	2.8
	33	3.1	2.4	3.7	2.7	4.3	2.9	4.5	3.0	4.7	3.0	5.0	3.0	5.3	2.8
	35	3.1	2.4	3.7	2.7	4.3	2.9	4.5	3.0	4.7	3.0	5.0	3.0	5.3	2.8
	37	3.1	2.4	3.7	2.7	4.3	2.9	4.5	3.0	4.7	3.0	4.9	2.9	5.2	2.7
	39	3.1	2.4	3.7	2.7	4.3	2.9	4.5	3.0	4.7	3.0	4.9	2.9	5.1	2.6
42	3.1	2.4	3.7	2.7	4.2	2.9	4.4	3.0	4.6	3.0	4.8	2.9	5.0	2.5	
44	3.1	2.4	3.7	2.7	4.1	2.8	4.3	2.9	4.5	2.9	4.6	2.8	4.8	2.5	
46	3.1	2.4	3.7	2.7	4.0	2.8	4.2	2.8	4.3	2.8	4.5	2.7	4.7	2.4	
48	3.1	2.3	3.6	2.6	4.0	2.7	4.0	2.7	4.3	2.7	4.3	2.6	4.5	2.3	
056	10	3.9	3.0	4.6	3.4	5.3	3.7	5.6	3.8	5.8	3.8	6.3	3.9	6.7	3.6
	12	3.9	3.0	4.6	3.4	5.3	3.7	5.6	3.8	5.8	3.8	6.3	3.9	6.7	3.6
	14	3.9	3.0	4.6	3.4	5.3	3.7	5.6	3.8	5.8	3.8	6.2	3.8	6.7	3.6
	16	3.9	3.0	4.6	3.4	5.3	3.7	5.6	3.8	5.8	3.8	6.2	3.8	6.6	3.5
	18	3.9	3.0	4.6	3.4	5.3	3.7	5.6	3.8	5.8	3.8	6.2	3.8	6.6	3.5
	20	3.9	3.0	4.6	3.4	5.3	3.7	5.6	3.8	5.8	3.8	6.2	3.8	6.6	3.5
	21	3.9	3.0	4.6	3.4	5.3	3.7	5.6	3.8	5.8	3.8	6.2	3.8	6.6	3.5
	23	3.9	3.0	4.6	3.4	5.3	3.7	5.6	3.8	5.8	3.8	6.2	3.8	6.6	3.5
	25	3.9	3.0	4.6	3.4	5.3	3.7	5.6	3.8	5.8	3.8	6.2	3.8	6.6	3.5
	27	3.9	3.0	4.6	3.4	5.3	3.7	5.6	3.8	5.8	3.8	6.2	3.8	6.6	3.5
	29	3.9	3.0	4.6	3.4	5.3	3.7	5.6	3.8	5.8	3.8	6.2	3.8	6.6	3.5
	31	3.9	3.0	4.6	3.4	5.3	3.7	5.6	3.8	5.8	3.8	6.2	3.8	6.6	3.5
	33	3.9	3.0	4.6	3.4	5.3	3.7	5.6	3.8	5.8	3.8	6.2	3.8	6.6	3.5
	35	3.9	3.0	4.6	3.4	5.3	3.7	5.6	3.8	5.8	3.8	6.2	3.8	6.6	3.5
	37	3.9	3.0	4.6	3.4	5.3	3.7	5.6	3.8	5.8	3.8	6.1	3.7	6.5	3.4
	39	3.9	3.0	4.6	3.4	5.3	3.7	5.6	3.8	5.8	3.8	6.1	3.7	6.4	3.3
42	3.9	3.0	4.6	3.4	5.3	3.7	5.5	3.7	5.7	3.8	6.0	3.6	6.2	3.2	
44	3.9	3.0	4.6	3.4	5.1	3.6	5.3	3.6	5.6	3.6	5.8	3.5	6.0	3.1	
46	3.9	3.0	4.6	3.4	5.0	3.5	5.2	3.5	5.4	3.5	5.6	3.4	5.9	3.0	
48	3.9	3.0	4.5	3.3	5.0	3.5	5.0	3.4	5.3	3.5	5.4	3.3	5.7	2.9	



# 2 Capacity Table

## Console

### Heating

TC : Total Capacity(kW)

Capacity Index	Outdoor Air Temp. (°C )		Indoor temperature ( °C,DB )				
			16(°C,DB)	18(°C,DB)	20(°C,DB)	22(°C,DB)	24(°C,DB)
	DB	WB	TC kW	TC kW	TC kW	TC kW	TC kW
022	-19.8	-20.0	1.5	1.5	1.5	1.5	1.5
	-18.8	-19.0	1.5	1.5	1.5	1.5	1.5
	-16.7	-17.0	1.6	1.6	1.6	1.6	1.6
	-14.7	-15.0	1.7	1.6	1.6	1.6	1.6
	-12.6	-13.0	1.8	1.8	1.8	1.8	1.7
	-10.5	-11.0	2.0	2.0	1.9	1.9	1.9
	-9.5	-10.0	2.1	2.0	2.0	1.9	1.9
	-8.5	-9.1	2.2	2.1	2.1	2.0	2.0
	-7.0	-7.6	2.3	2.2	2.2	2.0	2.0
	-5.0	-5.6	2.4	2.3	2.3	2.2	2.2
	-3.0	-3.7	2.5	2.5	2.4	2.3	2.2
	0.0	-0.7	2.6	2.5	2.5	2.3	2.2
	3.0	2.2	2.7	2.6	2.5	2.3	2.2
	5.0	4.1	2.8	2.7	2.5	2.3	2.2
	7.0	6.0	2.8	2.7	2.5	2.3	2.2
9.0	7.9	3.0	2.7	2.5	2.3	2.2	
11.0	9.8	3.0	2.7	2.5	2.3	2.2	
13.0	11.8	3.0	2.7	2.5	2.3	2.2	
15.0	13.7	3.0	2.7	2.5	2.3	2.2	
028	-19.8	-20.0	1.9	1.9	1.9	1.9	1.9
	-18.8	-19.0	1.9	1.9	1.9	1.9	1.9
	-16.7	-17.0	2.0	2.0	2.0	2.0	1.9
	-14.7	-15.0	2.1	2.1	2.0	2.0	1.9
	-12.6	-13.0	2.2	2.2	2.2	2.1	2.1
	-10.5	-11.0	2.3	2.3	2.3	2.3	2.2
	-9.5	-10.0	2.3	2.3	2.3	2.3	2.2
	-8.5	-9.1	2.4	2.4	2.4	2.4	2.3
	-7.0	-7.6	2.5	2.4	2.4	2.4	2.3
	-5.0	-5.6	2.6	2.6	2.5	2.5	2.4
	-3.0	-3.7	2.8	2.7	2.7	2.6	2.5
	0.0	-0.7	2.9	2.8	2.8	2.7	2.6
	3.0	2.2	3.0	3.0	2.9	2.8	2.7
	5.0	4.1	3.2	3.1	3.1	2.9	2.7
	7.0	6.0	3.3	3.2	3.2	3.0	2.7
9.0	7.9	3.4	3.3	3.2	3.0	2.7	
11.0	9.8	3.5	3.3	3.2	3.0	2.7	
13.0	11.8	3.6	3.4	3.2	3.0	2.7	
15.0	13.7	3.7	3.4	3.2	3.0	2.7	
036	-19.8	-20.0	2.4	2.4	2.3	2.3	2.3
	-18.8	-19.0	2.5	2.4	2.3	2.3	2.3
	-16.7	-17.0	2.6	2.5	2.4	2.4	2.3
	-14.7	-15.0	2.7	2.6	2.5	2.5	2.4
	-12.6	-13.0	2.8	2.7	2.7	2.6	2.6
	-10.5	-11.0	2.9	2.9	2.9	2.8	2.8
	-9.5	-10.0	2.9	2.9	2.9	2.8	2.8
	-8.5	-9.1	3.0	3.0	3.0	2.9	2.9
	-7.0	-7.6	3.1	3.1	3.0	3.0	2.9
	-5.0	-5.6	3.3	3.2	3.2	3.1	3.0
	-3.0	-3.7	3.4	3.4	3.3	3.2	3.1
	0.0	-0.7	3.6	3.6	3.5	3.4	3.2
	3.0	2.2	3.8	3.7	3.7	3.5	3.4
	5.0	4.1	3.9	3.9	3.8	3.6	3.4
	7.0	6.0	4.1	4.1	4.0	3.7	3.4
9.0	7.9	4.2	4.1	4.0	3.7	3.4	
11.0	9.8	4.4	4.2	4.0	3.7	3.4	
13.0	11.8	4.5	4.2	4.0	3.7	3.4	
15.0	13.7	4.6	4.3	4.0	3.7	3.4	

# 2 Capacity Table

## Console

### Heating

TC : Total Capacity(kW)

Capacity Index	Outdoor Air Temp. (°C)		Indoor temperature (°C,DB)				
			16(°C,DB)	18(°C,DB)	20(°C,DB)	22(°C,DB)	24(°C,DB)
	DB	WB	TC kW	TC kW	TC kW	TC kW	TC kW
045	-19.8	-20.0	3.1	3.0	3.0	2.9	2.9
	-18.8	-19.0	3.1	3.1	3.1	3.0	3.0
	-16.7	-17.0	3.2	3.2	3.1	3.0	3.0
	-14.7	-15.0	3.3	3.3	3.2	3.1	3.0
	-12.6	-13.0	3.5	3.4	3.3	3.3	3.2
	-10.5	-11.0	3.6	3.6	3.5	3.5	3.4
	-9.5	-10.0	3.7	3.7	3.6	3.5	3.5
	-8.5	-9.1	3.8	3.7	3.7	3.6	3.5
	-7.0	-7.6	3.9	3.8	3.8	3.7	3.6
	-5.0	-5.6	4.1	4.1	4.0	3.9	3.7
	-3.0	-3.7	4.3	4.2	4.2	4.1	3.9
	0.0	-0.7	4.5	4.4	4.4	4.2	4.0
	3.0	2.2	4.7	4.7	4.6	4.4	4.2
	5.0	4.1	4.9	4.8	4.8	4.5	4.2
	7.0	6.0	5.2	5.1	5.0	4.6	4.2
9.0	7.9	5.3	5.2	5.0	4.6	4.2	
11.0	9.8	5.5	5.2	5.0	4.6	4.2	
13.0	11.8	5.6	5.3	5.0	4.6	4.2	
15.0	13.7	5.8	5.4	5.0	4.6	4.2	
056	-19.8	-20.0	3.9	3.8	3.8	3.7	3.7
	-18.8	-19.0	3.9	3.9	3.8	3.7	3.7
	-16.7	-17.0	4.0	4.0	3.9	3.8	3.8
	-14.7	-15.0	4.2	4.1	4.0	3.9	3.8
	-12.6	-13.0	4.4	4.3	4.2	4.1	4.0
	-10.5	-11.0	4.6	4.5	4.4	4.4	4.3
	-9.5	-10.0	4.7	4.6	4.6	4.5	4.4
	-8.5	-9.1	4.8	4.7	4.7	4.6	4.5
	-7.0	-7.6	4.9	4.8	4.8	4.7	4.5
	-5.0	-5.6	5.2	5.1	5.0	4.9	4.7
	-3.0	-3.7	5.4	5.3	5.3	5.1	4.9
	0.0	-0.7	5.7	5.6	5.5	5.3	5.0
	3.0	2.2	5.9	5.9	5.8	5.6	5.3
	5.0	4.1	6.2	6.1	6.0	5.7	5.3
	7.0	6.0	6.5	6.4	6.3	5.8	5.3
9.0	7.9	6.7	6.5	6.3	5.8	5.3	
11.0	9.8	6.9	6.6	6.3	5.8	5.3	
13.0	11.8	7.1	6.7	6.3	5.8	5.3	
15.0	13.7	7.3	6.8	6.3	5.8	5.3	

# 3 Dimensional Drawing

## Console

AM022/045KNJDEH/EU, AM028/036FNJDEH/EU

[ Unit : mm ]

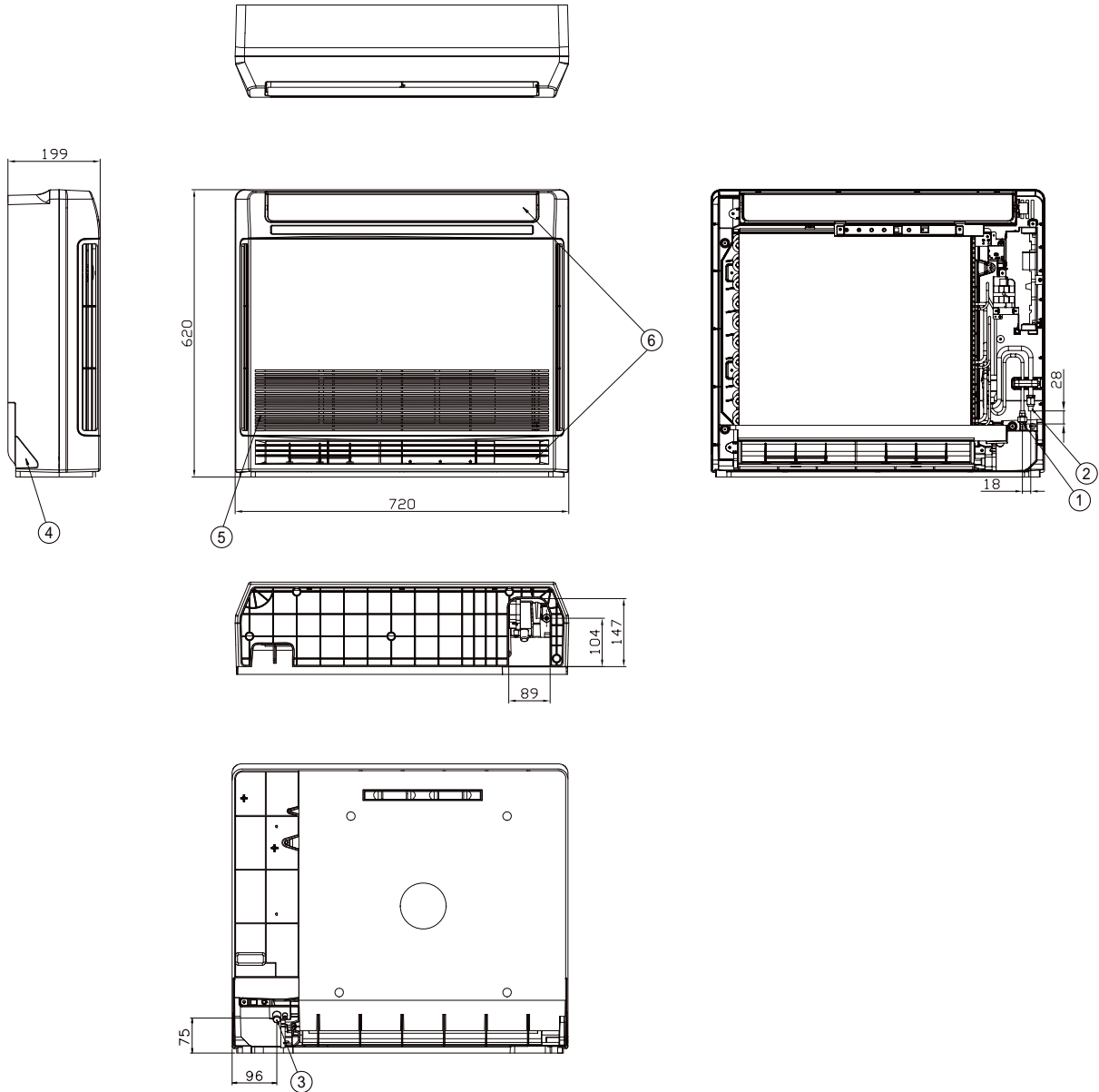

No.	Name	Description			
		2.2kW	2.8kW	3.6kW	4.5kW
①	Liquid pipe connection	Ø6.35 Flare			
②	Gas pipe connection	Ø12.70 Flare			
③	Drain pipe connection	ID18 Hose			
④	Conduit for power supply & communication wiring	-			
⑤	Air inlet grille	-			
⑥	Air outlet louver	-			

# 3 Dimensional Drawing

## Console

AM056FNJDEH/EU

[ Unit : mm ]

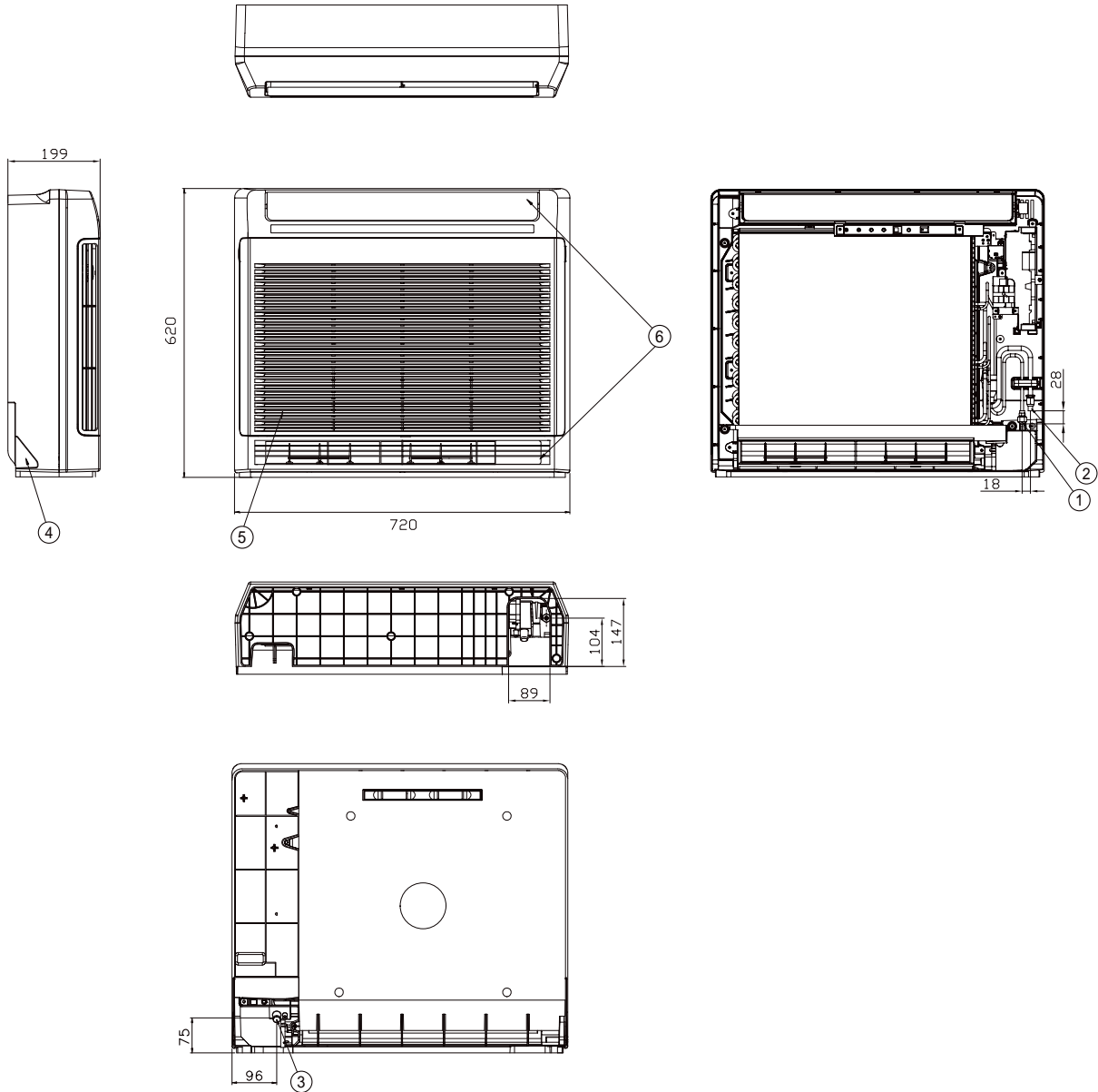

No.	Name	Description
		5.6kW
①	Liquid pipe connection	Ø6.35 Flare
②	Gas pipe connection	Ø12.70 Flare
③	Drain pipe connection	ID18 Hose
④	Conduit for power supply & communication wiring	-
⑤	Air inlet grille	-
⑥	Air outlet louver	-

# 4 Electrical Wiring Diagram

## Console

AM022/045KNJDEH/EU, AM028/036/056FNJDEH/EU

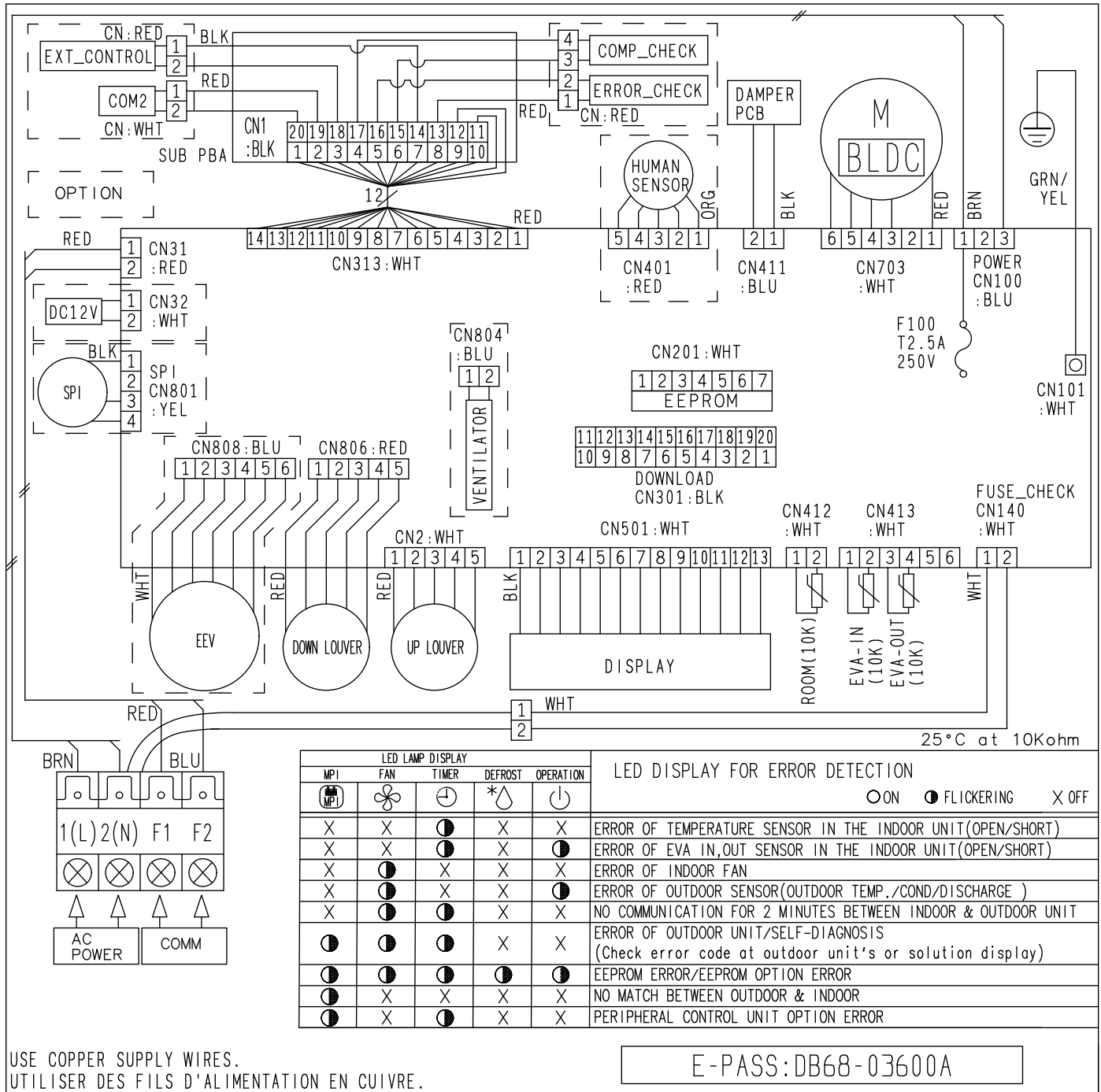

USE COPPER SUPPLY WIRES.  
UTILISER DES FILS D'ALIMENTATION EN CUIVRE.

E-PASS: DB68-03600A

### NOTE

1. This wiring diagram applies only to the indoor unit.
2. Symbols show as follow;  
BLK : black, RED : red, BLU : blue, WHT:white, YEL : yellow, BRN : brown, SKY : sky-blue, GRN : green
3. For connection wiring indoor-outdoor transmission F1-F2, indoor-wired remotecontroller transmission F3-F4.
4. : Protective earth(screw), : Connector, n : The wire quantity

# 5 Sound Pressure Level

## Console

Unit: dB(A)

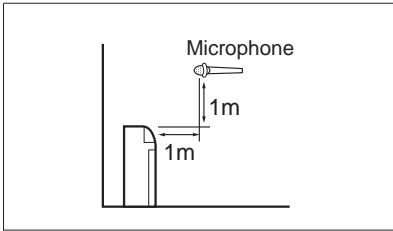

Model	High	Low
AM022KNJDEH/EU	34	30
AM045KNJDEH/EU	42	36

### Note

Specifications may be subject to change without prior notice.  
 Sound pressure level is obtained in an anechoic room.  
 Sound pressure level is a relative value, depending on the distance and acoustic environment.  
 Sound pressure level may differ depending on operation condition.  
 dBA = A-weighted sound pressure level  
 Reference acoustic pressure 0 dB= 20 uPa

## NC curve

1) AM022KNJDEH/EU

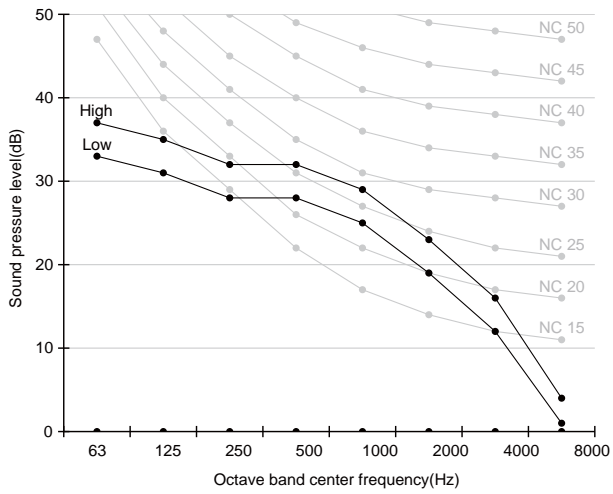

2) AM045KNJDEH/EU

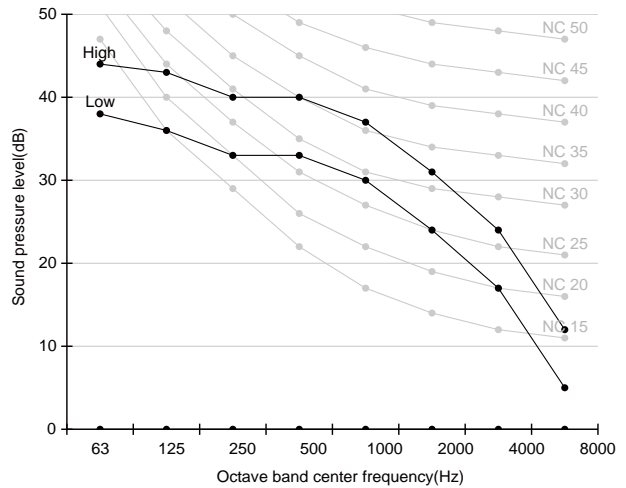

# 5 Sound Pressure Level

## Console

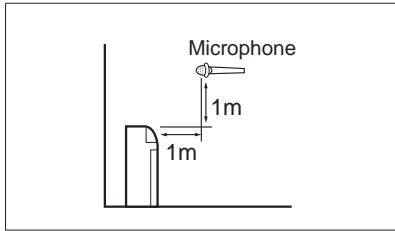

Unit: dB(A)

Model	High	Low
AM028FNJDEH/EU	38	34
AM036FNJDEH/EU	39	34
AM056FNJDEH/EU	43	37

### Note

Specifications may be subject to change without prior notice.  
 Sound pressure level is obtained in an anechoic room.  
 Sound pressure level is a relative value, depending on the distance and acoustic environment.  
 Sound pressure level may differ depending on operation condition.  
 dBA = A-weighted sound pressure level  
 Reference acoustic pressure 0 dB= 20 uPa

## NC curve

1) AM028FNJDEH/EU

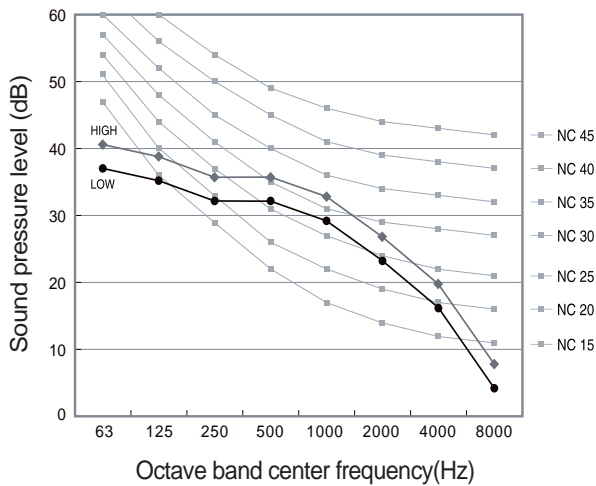

2) AM036FNJDEH/EU

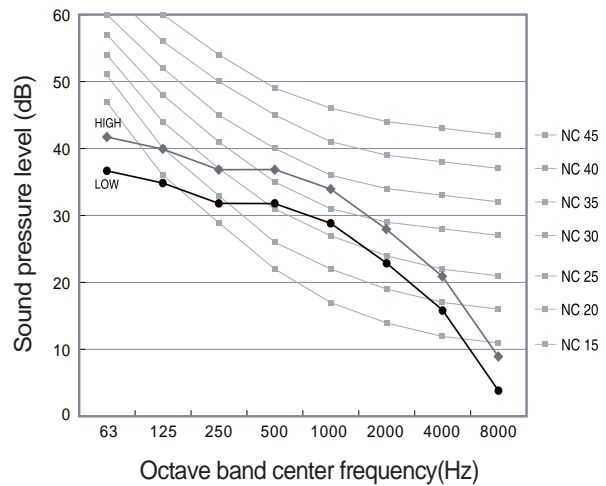

3) AM056FNJDEH/EU

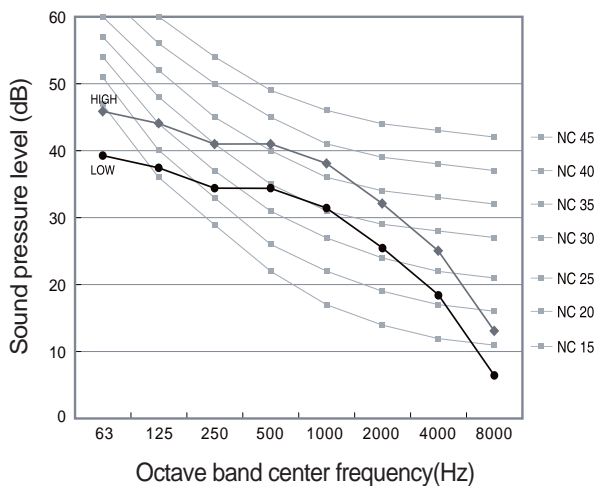

# 6 Sound Power Level

## Console

Unit: dB(A)

### Note

- . Specifications may be subject to change without prior notice.
- . Sound power level is an absolute value that a sound source generates.
- . dBA = A-weighted sound power level.
- . Reference power : 1pW.
- . Measured according to ISO 3741

Model	Power
AM022KNJDEH/EU	52
AM028FNJDEH/EU	58
AM036FNJDEH/EU	59
AM045KNJDEH/EU	63
AM056FNJDEH/EU	64

1) AM022KNJDEH/EU

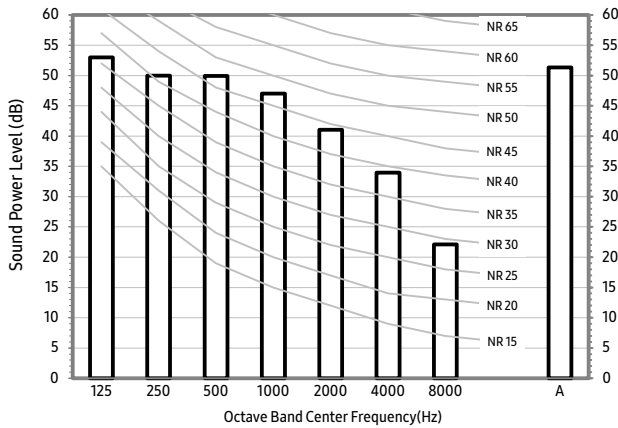

2) AM028FNJDEH/EU

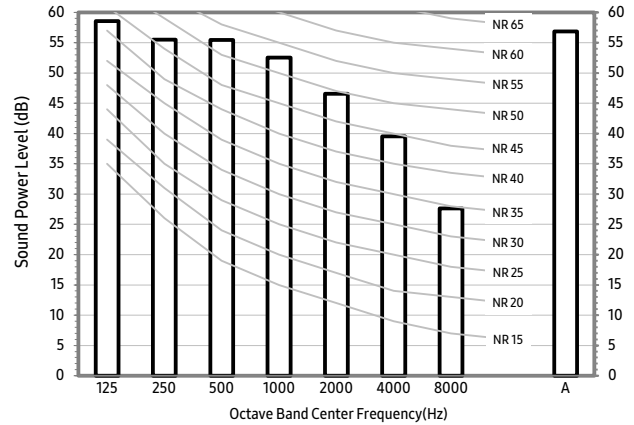

3) AM036FNJDEH/EU

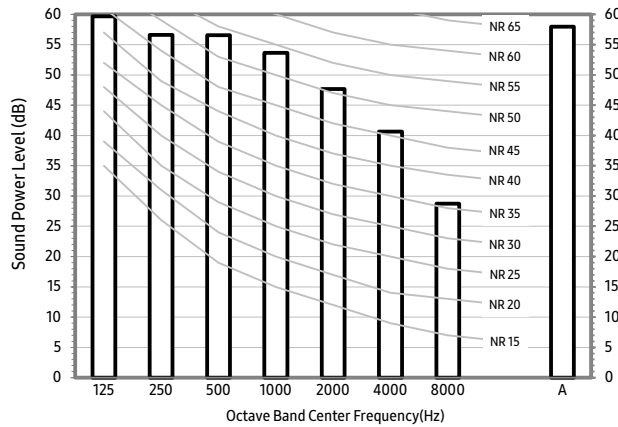

4) AM045KNJDEH/EU

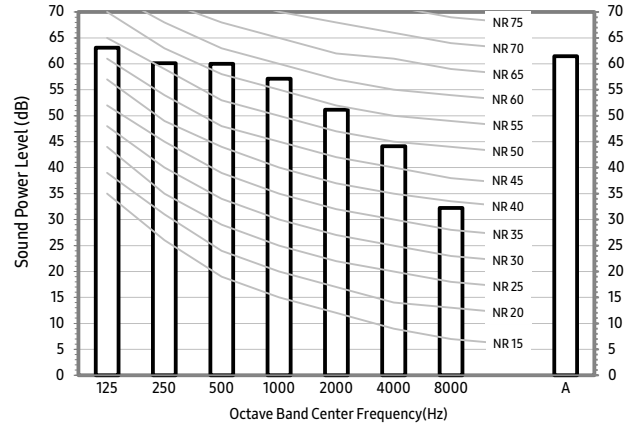

5) AM056FNJDEH/EU

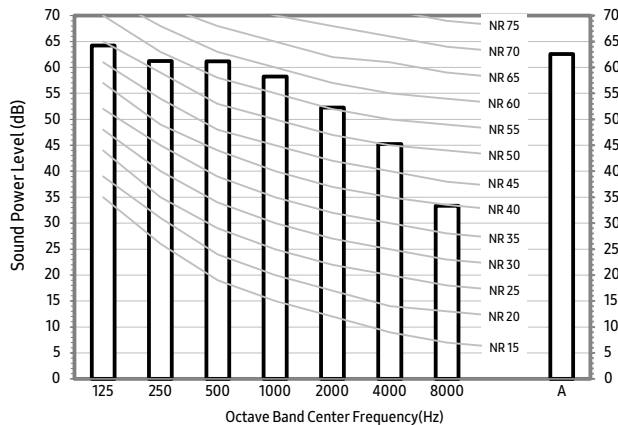



# 7 Temperature and air flow distribution

## Console

AM022KNJDEH/EU

### (1) Cooling air velocity distribution

Discharge angle (Default) : 40°

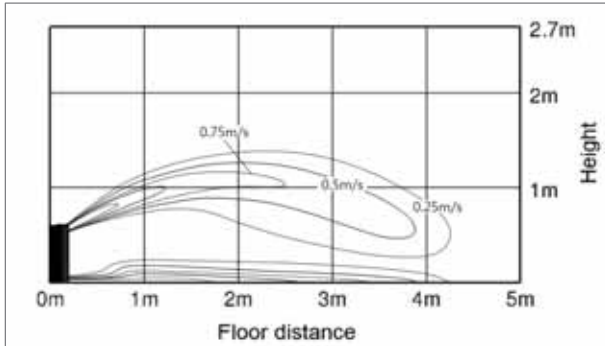

### (2) Cooling temperature distribution

Discharge angle (Default) : 40°

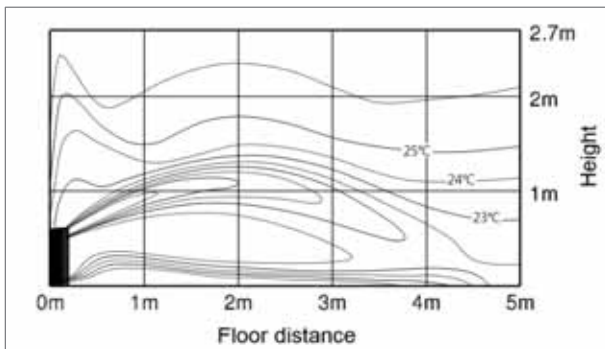

### (3) Heating air velocity distribution

Discharge angle (Default) : 4°

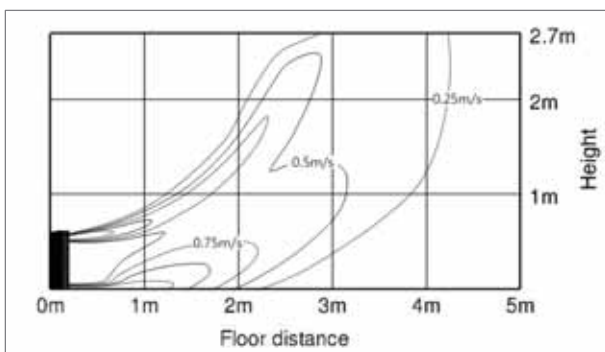

### (4) Heating temperature distribution

Discharge angle (Default) : 4°

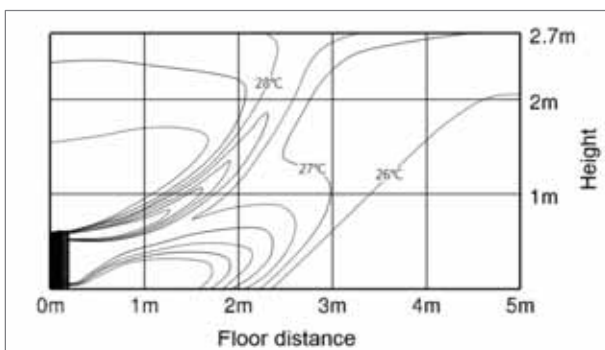

# 7 Temperature and air flow distribution

## Console

AM028FNJDEH/EU

### (1) Cooling air velocity distribution

Discharge angle (Default) : 40°

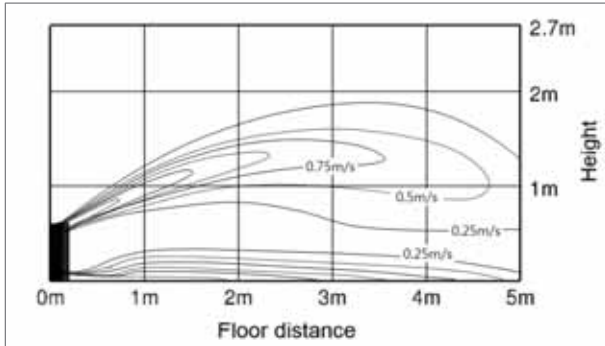

### (2) Cooling temperature distribution

Discharge angle (Default) : 40°

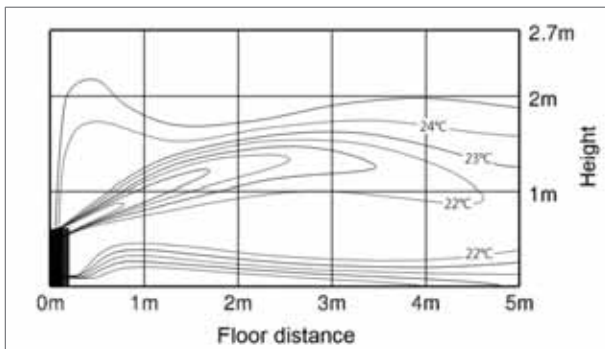

### (3) Heating air velocity distribution

Discharge angle (Default) : 4°

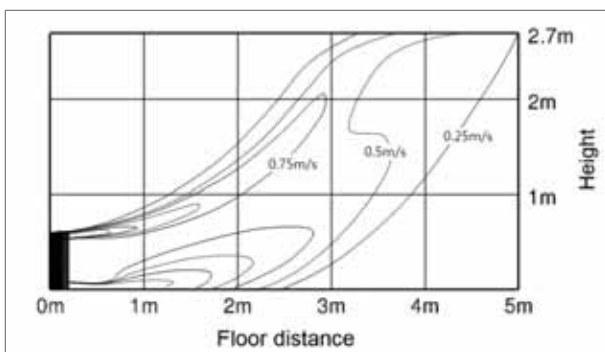

### (4) Heating temperature distribution

Discharge angle (Default) : 4°

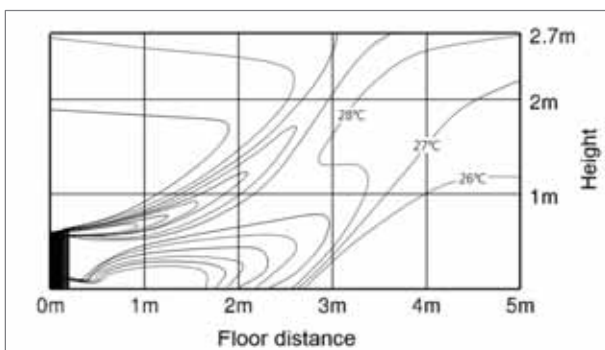

# 7 Temperature and air flow distribution

## Console

AM036FNJDEH/EU

### (1) Cooling air velocity distribution

Discharge angle (Default) : 40°

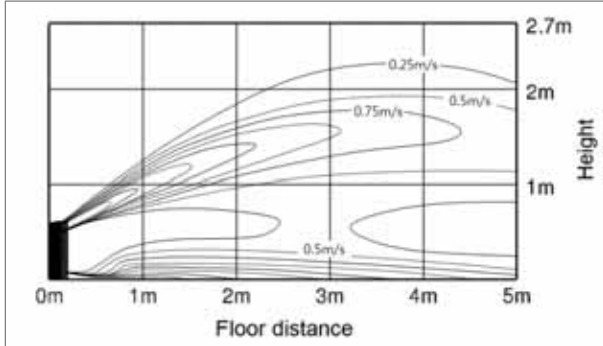

### (2) Cooling temperature distribution

Discharge angle (Default) : 40°

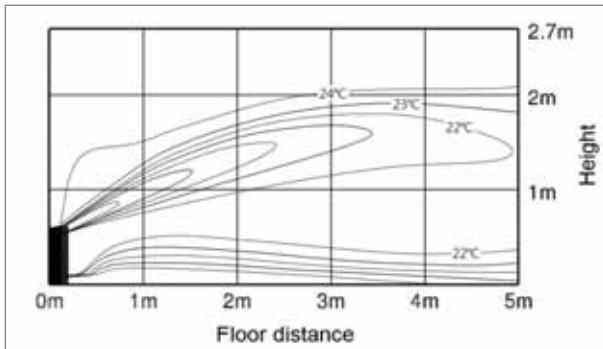

### (3) Heating air velocity distribution

Discharge angle (Default) : 4°

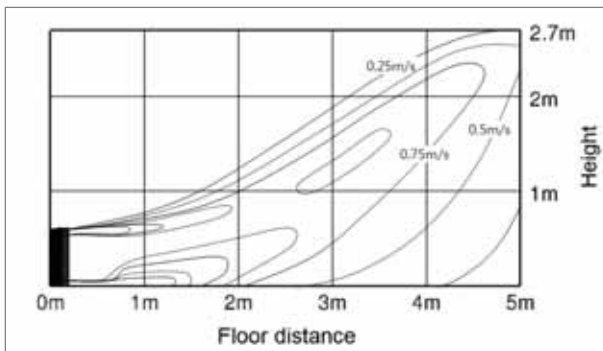

### (4) Heating temperature distribution

Discharge angle (Default) : 4°

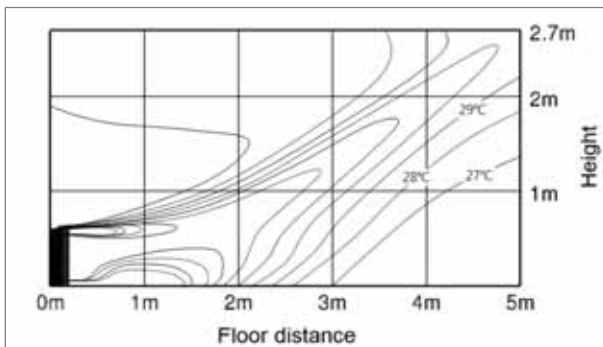

# 7 Temperature and air flow distribution

## Console

AM045KNJDEH/EU

### (1) Cooling air velocity distribution

Discharge angle (Default) : 40°

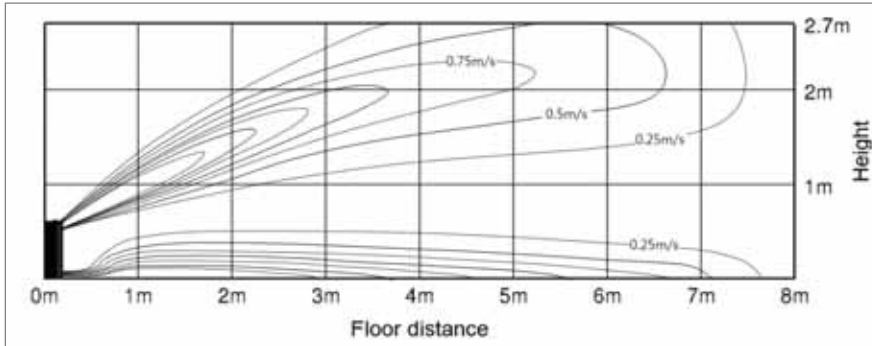

### (2) Cooling temperature distribution

Discharge angle (Default) : 40°

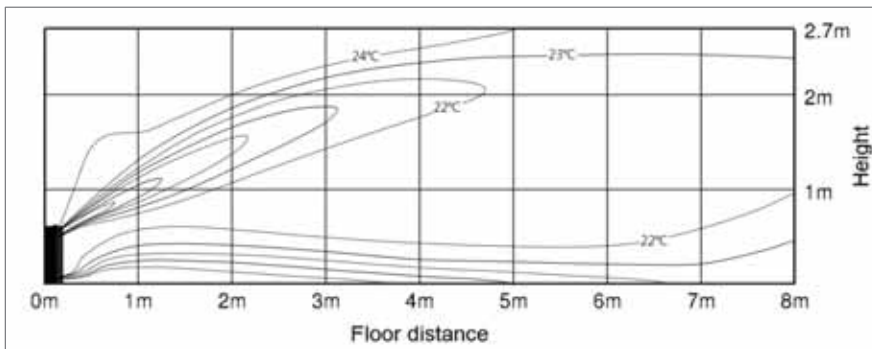

### (3) Heating air velocity distribution

Discharge angle (Default) : 4°

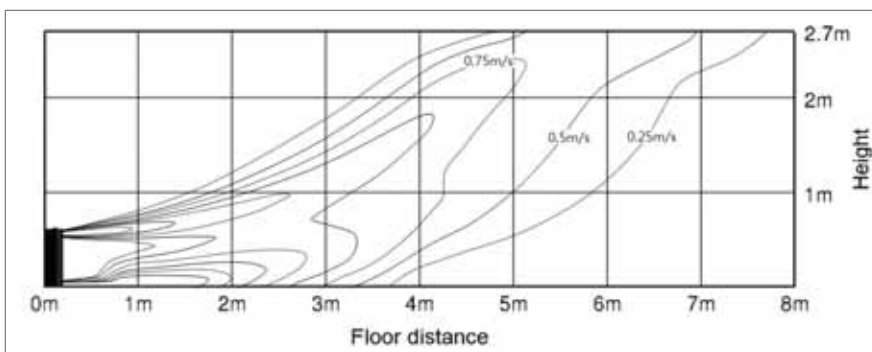

### (4) Heating temperature distribution

Discharge angle (Default) : 4°

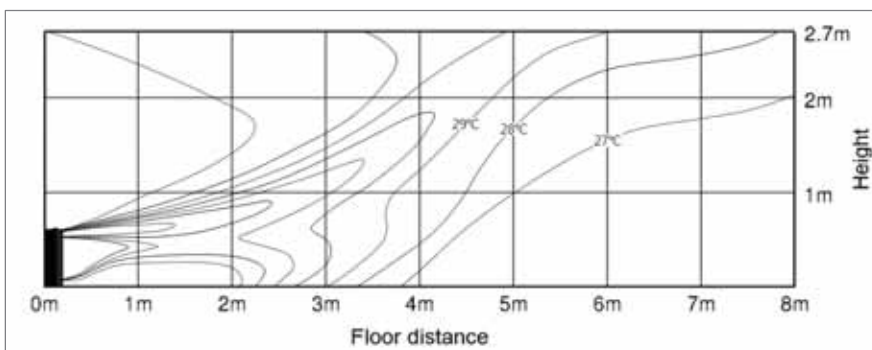

# 7 Temperature and air flow distribution

## Console

AM056FNJDEH/EU

(1) Cooling air velocity distribution

Discharge angle (Default) : 40°

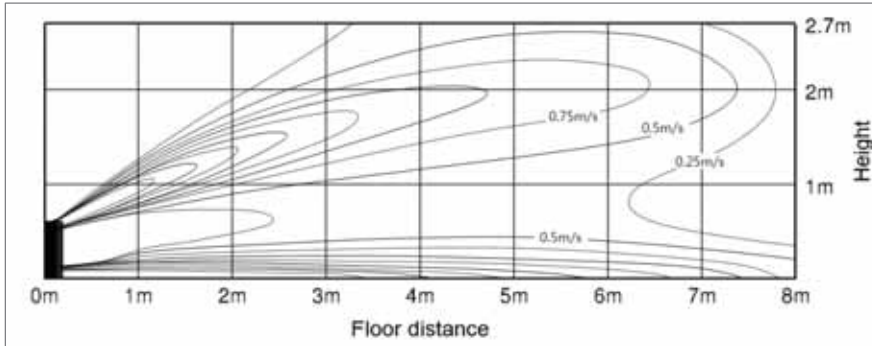

(2) Cooling temperature distribution

Discharge angle (Default) : 40°

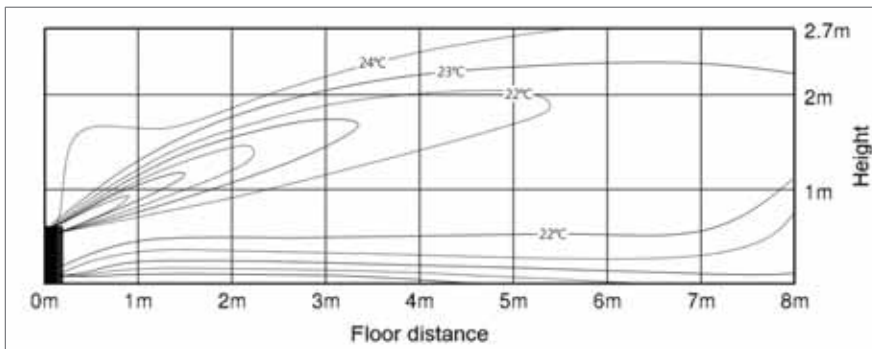

(3) Heating air velocity distribution

Discharge angle (Default) : 4°

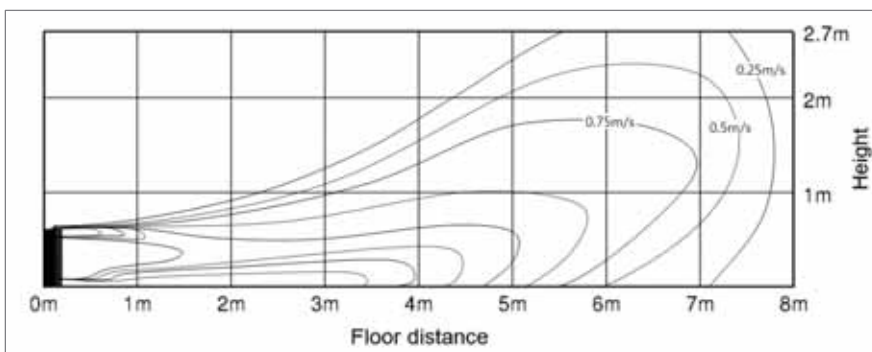

(4) Heating temperature distribution

Discharge angle (Default) : 4°

