

SAMSUNG

Climate Solutions

Price List

v1.0 2022

2022

Note: Unless stated otherwise, all cooling and heating capacities shown are based on following test conditions:

Nominal Conditions Cooling:

Indoor Temperature: 27°C DB, 19°C WB

Outdoor temperature: 35°C DB

Nominal Conditions Heating:

Indoor Temperature: 20°C DB





Outdoor Temperature: 7°C DB, 6°C WB



v1.0 Contents











Type	Product	Description	Page
	SPLIT	Quick Price guide - Single Split Systems	2
	SPLIT	Quick Price guide - DPM Twin, Triple, Quad systems	3
Residential	RAC	Small capacity high wall systems	4-5
Commercial Single Split Systems	SPLIT	360 cassette - Circular	6
	SPLIT	4way cassette - WindFree™	7
	SPLIT	4way mini cassette - WindFree™	8
	SPLIT	1way cassette - WindFree™	8
	SPLIT	Ceiling Suspended	9
	SPLIT	Console Floor & Ceiling/Floor	10
	SPLIT	High Wall - WindFree™ 2.5-7kW and 10kW Std	11
	SPLIT	MSP Duct S	12
	SPLIT	Slim Duct	13
	SPLIT	HSP Duct	13
	SPLIT	High Efficiency Cassette & Ducted	14
	SPLIT	High Efficiency Wall	15
	SPLIT	PAC Floor Cabinet	15
	SPLIT	Accessories & Controls	16
Commercial Twin, Triple & Quad systems	DPM	Twin Triple Quad - 4way mini cassette	17
	DPM	Twin Triple Quad - 1way cassette	17
	DPM	Twin Triple Quad - 4way cassette	18
	DPM	Twin Triple Quad - 360 cassette	18
	DPM	Twin Triple Quad - Slim Duct	19
	DPM	Twin Triple Quad - MSP Duct S	20
	DPM	Twin Triple Quad - Wall	21
	DPM	Twin Triple Quad - Ceiling	22
	DPM	Twin Triple Quad - Accessories	23
Mini-multi split systems	FJM	Outdoor units	24
	FJM	Wall indoor units (from RAC range)	24
	FJM	Console & Ducted indoor units	25
	FJM	4way cassette indoor units - WindFree™ & Standard	25
	FJM	1way cassette indoor units - WindFree™ & Standard	25
Ventilation	ERV	ERV - Energy Recovery Ventilators	26
	AHU	AHU Kits	26
VRF systems	DVM	Eco Outdoor units - 2pipe / 3pipe	28
	DVM	Water condenser units	28
	DVM	2-pipe Heat Pump Outdoor units	29
	DVM	3-pipe Heat Recovery Outdoor units	29
	DVM	Cassette Indoor units (360 & WindFree™)	30
	DVM	1way cassette & Slim Duct indoor units	31
	DVM	Ducted Indoor units	32
	DVM	Large Ducted Indoor units	32
	DVM	Ceiling Indoor units	33
	DVM	Console/Floor Indoor units	33
	DVM	Floor uncased & PAC Floor Cabinet Indoor units	33
	DVM	EHS HYDRO Indoor units	33
	DVM	Wall indoor units - WindFree™ & Standard	34
	DVM	MCU & Branch Kits	35
	DVM	Panels & Accessories	35
DVM	Controls	36	
CHILLER	CHILLER	DVM Chiller Outdoor units	38
	CHILLER	DVM Chiller FCU's	39
		Partner Portal - info and access instructions	40-41
ASHP	EHS	AIR SOURCE HEAT PUMPS - Monobloc, Split & TDM+	42-44
		Services - Delivery & Commissioning	45

List Price Quick Guide - RAC & Commercial Single Split systems





	R32 RAC	2.5kW	3.5kW	5kW	6.5kW	Control option
	Entry AR30 High Wall	£425	£477			infra-red control only
	Luzon High Wall	£477	£529	£815	£1,075	infra-red control standard Wired remote via interface
	Cebu High Wall	£523	£579	£893	£1,182	infra-red control standard Wired remote via interface
	Comfort WindFree High Wall	£622	£681	£973	£1,287	infra-red control standard Wired remote via interface
	Avant WindFree High Wall	£759	£833	£1,094	£1,417	infra-red control standard Wired remote via interface
	Elite WindFree High Wall	£926	£1,020			infra-red control standard Wired remote via interface
	Pure WindFree High Wall	£967	£1,063			infra-red control standard Wired remote via interface

	1phase	R32 SPLIT	2.5kW	3.5kW	5kW	7.1kW	10kW	12kW	14kW	Control	3phase	R410A	16kW	18kW	20kW	25kW
	360 Cassette					£1,837	£2,216	£2,449	£2,680	MWR-WG00JN standard						
	1way Cassette WindFree	£1,169	£1,251							MWR-WG00JN standard						
	4way Mini WindFree	£1,037	£1,139	£1,303	£1,604					MWR-WG00JN standard						
	4way Cassette WindFree			£1,435	£1,667	£2,039	£2,249	£2,470		MWR-WG00JN standard						
	Slim Duct	£1,007	£1,081	£1,219	£1,462					MWR-WG00JN standard						
	MSP Duct S		£1,088	£1,211	£1,471	£1,919	£2,113	£2,365		MWR-WG00JN standard						
	HSP Ducted									MWR-WG00JN standard	HSP Ducted			£4,147	£4,656	
	High Wall WindFree	£903	£976	£1,164	£1,422					Infra-red std 10kW wired as standard						
	High Wall					£1,958										
	Ceiling			£1,139	£1,363	£2,298	£2,547	£2,821		<8kW Infrared std >9kW wired as standard	Ceiling	£3,024				
	Floor Console	£879	£1,014	£1,189						Infra-red as standard						

* Prices are 1phase models (up to 14kW), 3phase 16-25kW, include Fascia (where applicable) and a wired remote (MWR-WG00JN) - 3phase models (10-14kW) will cost extra

Remote Controller options

			List Price
	AR-EH03E AR-KH03E (360)	Infra-red wireless Wall, Ceiling and floor units as std. optional for 1way, 4way, 360 cassettes 360 cassette has specific model	£34
	MWR-WG00JN	Premium wired controller - for all models (RAC will require interface kit)	£90
	MWR-SH11N	Simple Touch wired controller - for all models (RAC will require interface kit)	£88

List Price Quick Guide - DPM Twin, Triple & Quad systems

1phase										3phase					
	R32	7kW TWIN	10kW TWIN	10kW TRIPLE	12kW TRIPLE	12kW QUAD	14kW TWIN	14kW TRIPLE	14kW QUAD	R410A	20kW TWIN	20kW TRIPLE	20kW QUAD	25kW TWIN	25kW QUAD
	1way Cassette WindFree	2x3.5 £2,198		3x3.5 £3,093		4x3.5 £3,833			4x3.5 £4,019						
	4way Mini WindFree	2x3.5 £1,974	2x5.0 £2,414	3x3.5 £2,757	3x5.0 £3,067	4x3.5 £3,385	2x7.1 £2,923	3x5.0 £3,253	4x3.5 £3,571	4way Mini WindFree		3x7.1 £4,337	4x5.0 £4,610		4x7.1 £5,258
	4way Cassette WindFree		2x5.0 £2,678		3x5.0 £3,463		2x7.1 £3,049	3x5.0 £3,649		4way Cassette WindFree	2x10.0 £3,952	3x7.1 £4,526	4x5.0 £5,138	2x12.0 £4,374	4x7.1 £5,510
	360 Cassette						2x7.1 £3,389			360 Cassette	2x10.0 £4,306	3x7.1 £5,036		2x12.0 £4,774	4x7.1 £6,190
	Slim Duct	2x3.5 £1,858	2x5.0 £2,246	3x3.5 £2,583	3x5.0 £2,815	4x3.5 £3,153	2x7.1 £2,639	3x5.0 £3,001	4x3.5 £3,339	Slim Duct		3x7.1 £3,911	4x5.0 £4,274		4x7.1 £4,690
	MSP Duct S	2x3.5 £1,872	2x5.0 £2,230	3x3.5 £2,604	3x5.0 £2,791	4x3.5 £3,181	2x7.1 £2,657	3x5.0 £2,977	4x3.5 £3,367	MSP Duct S	2x10.0 £3,712	3x7.1 £3,938	4x5.0 £4,242	2x12.0 £4,102	4x7.1 £4,726
	Ceiling		2x5.0 £2,266		3x5.0 £2,845		2x7.1 £2,621	3x5.0 £3,031		Ceiling	2x10.0 £4,470	3x7.1 £3,884	4x5.0 £4,314	2x12.0 £4,970	4x7.1 £4,654
	High Wall WindFree	2x3.5 £1,648	2x5.0 £2,136	3x3.5 £2,268	3x5.0 £2,650	4x3.5 £2,733	2x7.1 £2,559	3x5.0 £2,836	4x3.5 £2,919	High Wall WindFree		3x7.1 £3,791	4x5.0 £4,054		4x7.1 £4,530
	High Wall									High Wall	2x10.0 £3,790				

* Prices are 1phase models (up to 14kW), 3phase 16-25kW, include Fascia (where applicable) and a wired remote (MWR-WG00JN) - 3phase models (10-14kW) will cost extra
 * Prices include associated branch pipe kit and 1 remote controller - **DPM systems must be installed in a single room/area**

DPM Piping Limitations

	R32		R410A
	7,10 & 12kW OU	14kW OU	20 & 25kW OU
Total Pipe length (all lengths combined)	50m	75m	75m
Max. Main pipe length (L ₁)	30m	50m	75m
Max. Leg length after branch pipe	15m		
Max. difference between leg length (e.g. L ₂ -L ₃)	5m		
Max. distance between Indoor units (D)	10m		
Max. height between Indoors & outdoor (h ₁)	30m		
Max. height difference between Indoors (h ₂)	0.5m		

* Indoor units should be installed in one area which is not divided by a wall & controlled via 1 remote

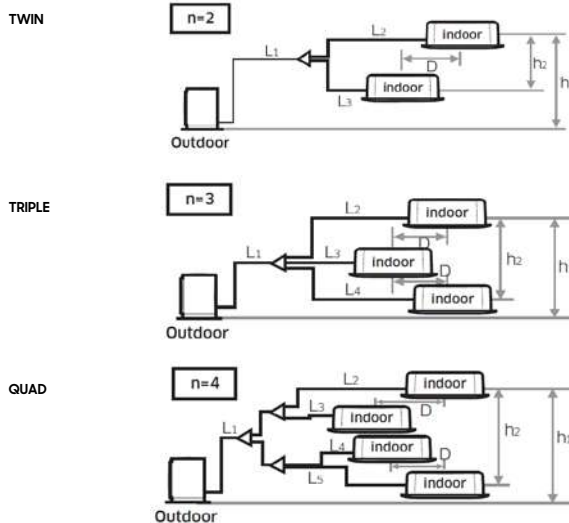

**High Wall System**

- AR30 - Entry level

1 PHASE - R32

Model Reference	Description	Cool	Heat	SEER	SCoP	Max Fuse	Pipe size Liq, Gas	Max pipe length (height)	LIST PRICE £
AR09TXHQBWKXEU	Inverter Heat Pump R32 Outdoor	2.6kW	2.9kW	6.3	4.0	10A	1/4", 3/8"	25m (10m)	247.00
AR09TXHQBWKNEU	AR30 High Wall Unit	(0.9-3.4kW)	(0.8-3.4kW)	A++	A+				178.00
System Price									425.00

AR12TXHQBWKXEU	Inverter Heat Pump R32 Outdoor	3.5kW	3.8kW	6.1	3.9	10A	1/4", 3/8"	25m (10m)	277.00
AR12TXHQBWKNEU	AR30 High Wall Unit	(1.1-4.2kW)	(1.1-4.2kW)	A++	A				200.00
System Price									477.00

NOTE: No hard-wired control option - Infra-red only

**Luzon High Wall System**

- Standard Wall mounted (wired control option via interface)

1 PHASE - R32

Model Reference	Description	Cool	Heat	SEER	SCoP	Max Fuse	Pipe size Liq, Gas	Max pipe length (height)	LIST PRICE £
AR09TXHZAWKXEU	Inverter Heat Pump R32 Outdoor	2.5kW	3.2kW	6.7	4.0	10A	1/4", 3/8"	15m (8m)	274.00
AR09TXHZAWKNEU	Luzon High Wall Unit	(0.9-3.4kW)	(0.9-4.5kW)	A++	A+				203.00
System Price									477.00

AR12TXHZAWKXEU	Inverter Heat Pump R32 Outdoor	3.5kW	3.5kW	6.5	4.0	10A	1/4", 3/8"	15m (8m)	304.00
AR12TXHZAWKNEU	Luzon High Wall Unit	(0.9-4.0kW)	(0.9-5.0kW)	A++	A+				225.00
System Price									529.00

AR18TXHZAWKXEU	Inverter Heat Pump R32 Outdoor	5.0kW	6.0kW	6.8	3.8	13A	1/4", 1/2"	30m (15m)	468.00
AR18TXHZAWKNEU	Luzon High Wall Unit	(1.6-6.7kW)	(1.3-8.0kW)	A++	A				347.00
System Price									815.00

AR24TXHZAWKXEU	Inverter Heat Pump R32 Outdoor	6.5kW	7.4kW	6.4	3.8	16A	1/4", 5/8"	30m (15m)	617.00
AR24TXHZAWKNEU	Luzon High Wall Unit	(1.4-7.6kW)	(1.2-9.4kW)	A++	A				458.00
System Price									1,075.00

**Cebu High Wall System**

- Standard Wall mounted with Wi-Fi Connectivity (wired control option via interface)

1 PHASE - R32

Model Reference	Description	Cool	Heat	SEER	SCoP	Max Fuse	Pipe size Liq, Gas	Max pipe length (height)	LIST PRICE £
AR09TXFYAWKXEU	Inverter Heat Pump R32 Outdoor	2.5kW	3.2kW	6.7	4.0	10A	1/4", 3/8"	15m (8m)	299.00
AR09TXFYAWKNEU	Cebu Standard High Wall Unit	(0.9-3.35kW)	(0.9-4.5kW)	A++	A+				224.00
System Price									523.00

AR12TXFYAWKXEU	Inverter Heat Pump R32 Outdoor	3.5kW	3.5kW	6.5	4.0	10A	1/4", 3/8"	15m (8m)	332.00
AR12TXFYAWKNEU	Cebu Standard High Wall Unit	(0.9-4.0kW)	(0.9-5.0kW)	A++	A+				247.00
System Price									579.00

AR18TXFYAWKXEU	Inverter Heat Pump R32 Outdoor	5.0kW	6.0kW	6.8	3.8	13A	1/4", 1/2"	30m (15m)	511.00
AR18TXFYAWKNEU	Cebu Standard High Wall Unit	(1.6-6.7kW)	(1.3-8.0kW)	A++	A				382.00
System Price									893.00

AR24TXFYAWKXEU	Inverter Heat Pump R32 Outdoor	6.5kW	7.4kW	6.4	3.8	16A	1/4", 5/8"	30m (15m)	678.00
AR24TXFYAWKNEU	Cebu Standard High Wall Unit	(1.4-7.6kW)	(1.2-9.4kW)	A++	A				504.00
System Price									1,182.00

New PM1.0 filter model

**PURE WindFree™ High Wall System**

- Draft Free operation with microholes, PM1.0 Filter & Wi-Fi connectivity (wired control option via interface)

1 PHASE - R32

Model Reference	Description	Cool	Heat	SEER	SCoP	Max Fuse	Pipe size Liq, Gas	Max pipe length (height)	LIST PRICE £
AR09AXKAawkNEU	Inverter Heat Pump R32 Outdoor	2.5kW	3.2kW	7.9	5.2	10A	1/4", 3/8"	15m (8m)	392.00
AR09AXKAawkXEU	Pure WindFree High Wall Unit	(0.9-3.4kW)	(0.7-6.5kW)	A++	A+++				575.00
System Price									967.00

AR12AXKAawkNEU	Inverter Heat Pump R32 Outdoor	3.5kW	4.0kW	7.2	5.2	13A	1/4", 3/8"	15m (8m)	427.00
AR12AXKAawkXEU	Pure WindFree High Wall Unit	(0.9-4.4kW)	(0.7-6.8kW)	A++	A+++				636.00
System Price									1,063.00



COMFORT WindFree™ High Wall System

- Draft Free operation with 23,000 microholes & Wi-Fi connectivity (wired control option via interface)

1 PHASE - R32										
Model Reference	Description	Cool	Heat	SEER	SCoP	Max Fuse	Pipe size Liq, Gas	Max pipe length (height)	LIST PRICE £	
AR09TXFCAWKXEU	Inverter Heat Pump R32 Outdoor	2.5kW	3.2kW	6.7	4.0	10A	1/4", 3/8"	15m (8m)	340.00	
AR09TXFCAWKNEU	Comfort WindFree High Wall Unit	(0.9-3.35kW)	(0.9-4.5kW)	A++	A+				282.00	
									System Price	622.00
AR12TXFCAWKXEU	Inverter Heat Pump R32 Outdoor	3.5kW	3.5kW	6.5	4.0	10A	1/4", 3/8"	15m (8m)	376.00	
AR12TXFCAWKNEU	Comfort WindFree High Wall Unit	(0.9-4.0kW)	(0.9-5.0kW)	A++	A+				305.00	
									System Price	681.00
AR18TXFCAWKXEU	Inverter Heat Pump R32 Outdoor	5.0kW	6.0kW	6.8	3.8	13A	1/4", 1/2"	30m (15m)	562.00	
AR18TXFCAWKNEU	Comfort WindFree High Wall Unit	(1.6-6.7kW)	(1.3-8.0kW)	A++	A				411.00	
									System Price	973.00
AR24TXFCAWKXEU	Inverter Heat Pump R32 Outdoor	6.5kW	7.4kW	6.4	3.8	16A	1/4", 5/8"	30m (15m)	727.00	
AR24TXFCAWKNEU	Comfort WindFree High Wall Unit	(1.4-7.6kW)	(1.2-9.4kW)	A++	A				560.00	
									System Price	1,287.00



AVANT WindFree™ High Wall System

- Draft Free operation with 23,000 microholes, Eco-Filter & Wi-Fi connectivity (wired control option via interface)

1 PHASE - R32										
Model Reference	Description	Cool	Heat	SEER	SCoP	Max Fuse	Pipe size Liq, Gas	Max pipe length (height)	LIST PRICE £	
AR09TXEAAWKXEU	Inverter Heat Pump R32 Outdoor	2.5kW	3.2kW	7.9	4.6	10A	1/4", 3/8"	15m (8m)	432.00	
AR09TXEAAWKNEU	Avant WindFree High Wall Unit	(0.9-3.35kW)	(0.72-5.0kW)	A++	A++				327.00	
									System Price	759.00
AR12TXEAAWKXEU	Inverter Heat Pump R32 Outdoor	3.5kW	4.0kW	7.3	4.6	10A	1/4", 3/8"	15m (8m)	476.00	
AR12TXEAAWKNEU	Avant WindFree High Wall Unit	(0.99-4.0kW)	(0.74-5.5kW)	A++	A++				357.00	
									System Price	833.00
AR18TXEAAWKXEU	Inverter Heat Pump R32 Outdoor	5.0kW	6.0kW	6.8	4.1	13A	1/4", 1/2"	30m (15m)	602.00	
AR18TXEAAWKNEU	Avant WindFree High Wall Unit	(1.6-6.7kW)	(1.3-8.0kW)	A++	A+				492.00	
									System Price	1,094.00
AR24TXEAAWKXEU	Inverter Heat Pump R32 Outdoor	6.5kW	7.4kW	6.4	4.0	16A	1/4", 5/8"	30m (15m)	764.00	
AR24TXEAAWKNEU	Avant WindFree High Wall Unit	(1.4-7.6kW)	(1.2-9.7kW)	A++	A+				653.00	
									System Price	1,417.00



ELITE WindFree™ High Wall System

- Draft Free operation with 23,000 microholes, Eco-Filter, Motion Sensor & Wi-Fi connectivity (wired control option via interface)

1 PHASE - R32										
Model Reference	Description	Cool	Heat	SEER	SCoP	Max Fuse	Pipe size Liq, Gas	Max pipe length (height)	LIST PRICE £	
AR09TXCAAWKXEU	Inverter Heat Pump R32 Outdoor	2.5kW	3.2kW	8.8	5.1	10A	1/4", 3/8"	15m (8m)	550.00	
AR09TXCAAWKNEU	Elite WindFree High Wall Unit	(0.9-3.6kW)	(0.8-7.1kW)	A+++	A+++				376.00	
									System Price	926.00
AR12TXCAAWKXEU	Inverter Heat Pump R32 Outdoor	3.5kW	4.0kW	8.5	5.1	13A	1/4", 3/8"	15m (8m)	610.00	
AR12TXCAAWKNEU	Elite WindFree High Wall Unit	(0.9-4.8kW)	(0.8-7.3kW)	A+++	A+++				410.00	
									System Price	1,020.00

*All RAC units supplied with infra-red remote control as standard

Accessories for RAC High Wall									LIST PRICE £
MIM-A00N	Interface to connect NASA wired remote controller to RAC High Wall (Check suitability)								23.00
MWR-WG00JN	LCD COLOUR PREMIUM Wired Controller (NASA)								90.00
MIM-R10N	Interface to connect RAC High Wall to Central Control network (Check outdoor suitability)								166.00

COMMERCIAL SPLIT SYSTEM

Air Conditioner

R32



360 Cassette

1 PHASE - R32		Max. Fuse	Pipe size Liq, Gas	Max. pipe length (height)	LIST PRICE £		
Model Reference	Description	Cool	Heat	SEER	SCoP		
AC071RXADKG/EU	1ph Inverter Heat Pump R32 Outdoor	7.1kW	8.0kW	6.7	4.2	20A	
AC071RN4PKG/EU	360 Cassette indoor	(1.5-8.7kW)	(1.9-9kW)	A++	A+	1/4", 5/8"	
PC4NUNMAN	360 Cassette Fascia Panel Round WHITE					50m (30m)	
MWR-WG00JN	LCD COLOUR Wired Controller (NASA)					957.00	
						646.00	
						144.00	
						90.00	
						System Price	1,837.00
AC100RXADKG/EU	1ph Inverter Heat Pump R32 Outdoor	10.0kW	11.2kW	6.8	4.3	30A	
AC100RN4PKG/EU	360 Cassette indoor	(3-12kW)	(2.2-15.5kW)	A++	A+	3/8", 5/8"	
PC4NUNMAN	360 Cassette Fascia Panel Round WHITE					50m (30m)	
MWR-WG00JN	LCD COLOUR Wired Controller (NASA)					1,295.00	
						687.00	
						144.00	
						90.00	
						System Price	2,216.00
AC120RXADKG/EU	1ph Inverter Heat Pump R32 Outdoor	12.0kW	13.2kW	6.0	4.0	30A	
AC120RN4PKG/EU	360 Cassette indoor	(3.5-13.5kW)	(3.5-15.5kW)	A+	A+	3/8", 5/8"	
PC4NUNMAN	360 Cassette Fascia Panel Round WHITE					50m (30m)	
MWR-WG00JN	LCD COLOUR Wired Controller (NASA)					1,452.00	
						763.00	
						144.00	
						90.00	
						System Price	2,449.00
AC140RXADKG/EU	1ph Inverter Heat Pump R32 Outdoor	13.4kW	15.5kW	6.4	4.1	40A	
AC140RN4PKG/EU	360 Cassette indoor	(3.5-15.5kW)	(3.5-18kW)			3/8", 5/8"	
PC4NUNMAN	360 Cassette Fascia Panel Round WHITE					75m (30m)	
MWR-WG00JN	LCD COLOUR Wired Controller (NASA)					1,638.00	
						808.00	
						144.00	
						90.00	
						System Price	2,680.00
3 PHASE - R32		Max. Fuse	Pipe size Liq, Gas	Max. pipe length (height)	LIST PRICE £		
Model Reference	Description	Cool	Heat	SEER	SCoP		
AC100RXADNG/EU	3ph Inverter Heat Pump R32 Outdoor	10.0kW	11.2kW	6.8	4.3	20A/ph	
AC100RN4PKG/EU	360 Cassette indoor	(3-12kW)	(2.2-15.5kW)	A++	A+	3/8", 5/8"	
PC4NUNMAN	360 Cassette Fascia Panel Round WHITE					50m (30m)	
MWR-WG00JN	LCD COLOUR Wired Controller (NASA)					1,367.00	
						687.00	
						144.00	
						90.00	
						System Price	2,288.00
AC120RXADNG/EU	3ph Inverter Heat Pump R32 Outdoor	12.0kW	13.2kW	6.0	4.0	20A/ph	
AC120RN4PKG/EU	360 Cassette indoor	(3.5-13.5kW)	(3.5-15.5kW)	A+	A+	3/8", 5/8"	
PC4NUNMAN	360 Cassette Fascia Panel Round WHITE					50m (30m)	
MWR-WG00JN	LCD COLOUR Wired Controller (NASA)					1,513.00	
						763.00	
						144.00	
						90.00	
						System Price	2,510.00
AC140RXADNG/EU	3ph Inverter Heat Pump R32 Outdoor	13.4kW	15.5kW	6.4	4.1	20A/ph	
AC140RN4PKG/EU	360 Cassette indoor	(3.5-15.5kW)	(3.5-18kW)			3/8", 5/8"	
PC4NUNMAN	360 Cassette Fascia Panel Round WHITE					75m (30m)	
MWR-WG00JN	LCD COLOUR Wired Controller (NASA)					1,694.00	
						808.00	
						144.00	
						90.00	
						System Price	2,736.00
Accessories for 360 Cassette						LIST PRICE £	
MWR-WG00JN	LCD COLOUR PREMIUM Wired Controller (NASA)					90.00	
MWR-SH11N	Simplified Wired Remote Controller (NASA)					88.00	
PC4NUDMAN	360 Cassette Fascia Panel - Square WHITE					144.00	
PC4NBDMAN	360 Cassette Fascia Panel - Square BLACK					144.00	
PC4NBNMAN	360 Cassette Fascia Panel - Round BLACK					144.00	
PC6EUCMAN	360 Cassette Fascia Panel Square - PURE Filter					457.00	
PC6EUXMAN	360 Cassette Fascia Panel Square - AutoLIFT					430.00	
MCR-SME	Motion detect sensor for 360 Cassette - for SQUARE panel					66.00	
MSD-CAN1	S-Plasma Ion Kit for 4way & 360Cassette & Large Ceiling					65.00	
AR-KH03E	360 Wireless Remote controller (SPLIT/DVM)					34.00	
MIM-H04EN	Wi-Fi Receiver 2.0 for NASA SPLIT/DVM IU					132.00	
MRW-TA	Remote Temperature Sensor					22.00	

COMMERCIAL SPLIT SYSTEM

Air Conditioner

R32

4way Cassette - WindFree™



7

1 PHASE - R32		Cool	Heat	SEER	SCoP	Max. Fuse	Pipe size Liq, Gas	Max. pipe length (height)	LIST PRICE £
Model Reference	Description								
AC052RXADKG/EU	1ph Inverter Heat Pump R32 Outdoor	5.0kW	6.0kW	7.6	4.3	20A	1/4", 1/2"	30m (20m)	739.00
AC052RN4DKG/EU	WindFree 4-Way Cassette (840mm x 840mm)	(1-6.5kW)	(1-7kW)	A++	A+				462.00
PC4NUFMAN	WindFree 4-Way Cassette Fascia Panel								144.00
MWR-WG00JN	LCD COLOUR Wired Controller (NASA)								90.00
System Price									1,435.00

AC071RXADKG/EU	1ph Inverter Heat Pump R32 Outdoor	7.1kW	8.0kW	6.7	4.2	20A	1/4", 5/8"	50m (30m)	957.00
AC071RN4DKG/EU	WindFree 4-Way Cassette (840mm x 840mm)	(1.5-8.7kW)	(1.9-9kW)	A++	A+				476.00
PC4NUFMAN	WindFree 4-Way Cassette Fascia Panel								144.00
MWR-WG00JN	LCD COLOUR Wired Controller (NASA)								90.00
System Price									1,667.00

AC100RXADKG/EU	1ph Inverter Heat Pump R32 Outdoor	10.0kW	11.2kW	7.0	4.3	25A	3/8", 5/8"	50m (30m)	1,295.00
AC100RN4DKG/EU	WindFree 4-Way Cassette (840mm x 840mm)	(3-12kW)	(2.2-15.5kW)	A++	A+				510.00
PC4NUFMAN	WindFree 4-Way Cassette Fascia Panel								144.00
MWR-WG00JN	LCD COLOUR Wired Controller (NASA)								90.00
System Price									2,039.00

AC120RXADKG/EU	1ph Inverter Heat Pump R32 Outdoor	12.0kW	13.2kW	6.0	4.0	30A	3/8", 5/8"	50m (30m)	1,452.00
AC120RN4DKG/EU	WindFree 4-Way Cassette (840mm x 840mm)	(3.5-13.5kW)	(3.5-15.5kW)	A+	A+				563.00
PC4NUFMAN	WindFree 4-Way Cassette Fascia Panel								144.00
MWR-WG00JN	LCD COLOUR Wired Controller (NASA)								90.00
System Price									2,249.00

AC140RXADKG/EU	1ph Inverter Heat Pump R32 Outdoor	13.4kW	15.5kW	6.6	4.3	40A	3/8", 5/8"	75m (30m)	1,638.00
AC140RN4DKG/EU	WindFree 4-Way Cassette (840mm x 840mm)	(3.5-15.5kW)	(3.5-18kW)						598.00
PC4NUFMAN	WindFree 4-Way Cassette Fascia Panel								144.00
MWR-WG00JN	LCD COLOUR Wired Controller (NASA)								90.00
System Price									2,470.00

3 PHASE - R32		Cool	Heat	SEER	SCoP	Max. Fuse	Pipe size Liq, Gas	Max. pipe length (height)	LIST PRICE £
Model Reference	Description								
AC100RXADNG/EU	3ph Inverter Heat Pump R32 Outdoor	10.0kW	11.2kW	7.0	4.3	20A/ph	3/8", 5/8"	50m (30m)	1,367.00
AC100RN4DKG/EU	WindFree 4-Way Cassette (840mm x 840mm)	(3-12kW)	(2.2-15.5kW)	A++	A+				510.00
PC4NUFMAN	WindFree 4-Way Cassette Fascia Panel								144.00
MWR-WG00JN	LCD COLOUR Wired Controller (NASA)								90.00
System Price									2,111.00

AC120RXADNG/EU	3ph Inverter Heat Pump R32 Outdoor	12.0kW	13.2kW	6.0	4.0	20A/ph	3/8", 5/8"	50m (30m)	1,513.00
AC120RN4DKG/EU	WindFree 4-Way Cassette (840mm x 840mm)	(3.5-13.5kW)	(3.5-15.5kW)	A+	A+				563.00
PC4NUFMAN	WindFree 4-Way Cassette Fascia Panel								144.00
MWR-WG00JN	LCD COLOUR Wired Controller (NASA)								90.00
System Price									2,310.00

AC140RXADNG/EU	3ph Inverter Heat Pump R32 Outdoor	13.4kW	15.5kW	6.6	4.3	20A/ph	3/8", 5/8"	75m (30m)	1,694.00
AC140RN4DKG/EU	WindFree 4-Way Cassette (840mm x 840mm)	(3.5-15.5kW)	(3.5-18kW)						598.00
PC4NUFMAN	WindFree 4-Way Cassette Fascia Panel								144.00
MWR-WG00JN	LCD COLOUR Wired Controller (NASA)								90.00
System Price									2,526.00

Accessories for WindFree 4way Cassette		LIST PRICE £
MWR-WG00JN	LCD COLOUR Wired Controller (NASA)	90.00
MWR-SH11N	Touch Simplified Wired Remote Controller - WindFree™ (NASA)	88.00
PC4NUFMAN	WindFree 4-Way Cassette Fascia Panel	144.00
PC4NUCEAN	WindFree 4-Way Cassette Fascia Panel - PURE Filter	515.00
PC4NUXMAN	WindFree 4-Way Cassette Fascia Panel - AutoLIFT	358.00
MCR-SMC	Motion detect sensor for 4-way wind-free Cassette - for 950x950 panel	66.00
MSD-CAN1	S-Plasma Ion Kit for 4way & 360Cassette & Large Ceiling	65.00
AR-EH03E	WindFree & STANDARD Wireless Remote controller (SPLIT/DVM)	34.00
MIM-H04EN	NEW Wi-Fi Receiver 2.0 for NASA SPLIT/DVM IU	132.00
MRW-TA	Remote Temperature Sensor	22.00

COMMERCIAL SPLIT SYSTEM

Air Conditioner

4way Mini Cassette - WindFree™

R32



1 PHASE - R32		Cool	Heat	SEER	SCoP	Max. Fuse	Pipe size Liq, Gas	Max. pipe length (height)	LIST PRICE £
Model Reference	Description								
AC026RXADKG/EU	1ph Inverter Heat Pump R32 Outdoor	2.6kW	3.4kW	7.1	4.3	13A	1/4", 3/8"	20m (15m)	564.00
AC026RNNDKG/EU	WindFree 4-Way Cassette (575mm x 575mm)	(0.87-4.1kW)	(0.98-4.1kW)	A++	A+				244.00
PC4SUFMAN	WindFree Mini 4-Way Cassette Fascia Panel								139.00
MWR-WG00JN	LCD COLOUR Wired Controller (NASA)								90.00
System Price									1,037.00

AC035RXADKG/EU	1ph Inverter Heat Pump R32 Outdoor	3.5kW	4.0kW	7.0	4.3	13A	1/4", 3/8"	20m (15m)	626.00
AC035RNNDKG/EU	WindFree 4-Way Cassette (575mm x 575mm)	(0.88-4.5kW)	(1-4.8kW)	A++	A+				284.00
PC4SUFMAN	WindFree Mini 4-Way Cassette Fascia Panel								139.00
MWR-WG00JN	LCD COLOUR Wired Controller (NASA)								90.00
System Price									1,139.00

AC052RXADKG/EU	1ph Inverter Heat Pump R32 Outdoor	5.0kW	5.5kW	6.7	4.2	20A	1/4", 1/2"	30m (20m)	739.00
AC052RNNDKG/EU	WindFree 4-Way Cassette (575mm x 575mm)	(1.3-6.2kW)	(1.3-7.5kW)	A++	A+				335.00
PC4SUFMAN	WindFree Mini 4-Way Cassette Fascia Panel								139.00
MWR-WG00JN	LCD COLOUR Wired Controller (NASA)								90.00
System Price									1,303.00

AC071RXADKG/EU	1ph Inverter Heat Pump R32 Outdoor	6.8kW	7.5kW	6.1	3.8	20A	1/4", 5/8"	50m (30m)	957.00
AC071RNNDKG/EU	WindFree 4-Way Cassette (575mm x 575mm)	(1.5-8.3kW)	(1.9-9kW)	A++	A				418.00
PC4SUFMAN	WindFree Mini 4-Way Cassette Fascia Panel								139.00
MWR-WG00JN	LCD COLOUR Wired Controller (NASA)								90.00
System Price									1,604.00

Accessories for WindFree 4way mini Cassette LIST PRICE £

MWR-WG00JN	LCD COLOUR Wired Controller (NASA)	90.00
MWR-SH11N	Touch Simplified Wired Remote Controller - WindFree™ (NASA)	88.00
PC4SUFMAN	WindFree Mini 4-Way Cassette Fascia Panel - 620x620	139.00
MCR-SMD	Motion detect sensor for 4-way wind-free Cassette - for 620x620 panel	66.00
MSD-CAN1	S-Plasma Ion Kit for 4way & 360Cassette & Large Ceiling	65.00
AR-EH03E	WindFree & STANDARD Wireless Remote controller (SPLIT/DVM)	34.00
MIM-H04EN	NEW Wi-Fi Receiver 2.0 for NASA SPLIT/DVM IU	132.00
MRW-TA	Remote Temperature Sensor	22.00

1way Cassette - WindFree™

R32



1 PHASE - R32		Cool	Heat	SEER	SCoP	Max. Fuse	Pipe size Liq, Gas	Max. pipe length (height)	LIST PRICE £
Model Reference	Description								
AC026RXADKG/EU	1ph Inverter Heat Pump R32 Outdoor	2.6kW	3.3kW	6.4	4.0	13A	1/4", 3/8"	20m (15m)	564.00
AC026RN1DKG/EU	WindFree 1-Way Cassette	(0.82-3.8kW)	(0.85-4.4kW)	A++	A+				376.00
PC1NWFMAN	WindFree 1-Way Cassette Panel - Medium								139.00
MWR-WG00JN	LCD COLOUR Wired Controller (NASA)								90.00
System Price									1,169.00

AC035RXADKG/EU	1ph Inverter Heat Pump R32 Outdoor	3.5kW	4.0kW	6.2	4.0	13A	1/4", 3/8"	20m (15m)	626.00
AC035RN1DKG/EU	WindFree 1-Way Cassette	(0.98-4.2kW)	(1-5kW)	A++	A+				396.00
PC1NWFMAN	WindFree 1-Way Cassette Panel - Medium								139.00
MWR-WG00JN	LCD COLOUR Wired Controller (NASA)								90.00
System Price									1,251.00

Accessories for WindFree 1way slim Cassette LIST PRICE £

MWR-WG00JN	LCD COLOUR Wired Controller (NASA)	90.00
MWR-SH11N	Touch Simplified Wired Remote Controller - WindFree™ (NASA)	88.00
PC1NWFMAN	WindFree 1-Way Cassette Fascia Panel - Medium	139.00
PC1NWCMAN	WindFree 1-Way Cassette Fascia Panel - Medium - PURE Filter	430.00
AR-EH03E	WindFree & STANDARD Wireless Remote controller (SPLIT/DVM)	34.00
MIM-H04EN	Wi-Fi Receiver 2.0 for NASA SPLIT/DVM IU	132.00
MRW-TA	Remote Temperature Sensor	22.00

COMMERCIAL SPLIT SYSTEM

Air Conditioner

R32



Ceiling / Floor

1 PHASE - R32		Cool	Heat	SEER	SCoP	Max. Fuse	Pipe size Liq, Gas	Max. pipe length (height)	LIST PRICE £
Model Reference	Description								

AC052RXADKG/EU	1ph Inverter Heat Pump R32 Outdoor	5.0kW	6.0kW	6.4	3.9	20A	1/4", 1/2"	30m (20m)	739.00
AC052RNCDKG/EU	Under Ceiling / Floor Standing Unit	(1.2-6.5kW)	(1.7-7.7kW)	A++	A				400.00
MR-EH00	Wireless Remote Controller								included
								System Price	1,139.00

AC071RXADKG/EU	1ph Inverter Heat Pump R32 Outdoor	7.1kW	8.0kW	5.6	3.9	25A	1/4", 5/8"	50m (30m)	957.00
AC071RNCDKG/EU	Under Ceiling / Floor Standing Unit	(1.5-8.7kW)	(1.9-9kW)	A+	A				406.00
MR-EH00	Wireless Remote Controller								included
								System Price	1,363.00

Accessories for Ceiling/Floor LIST PRICE £

MWR-WG00JN	LCD COLOUR Wired Controller (NASA)	90.00
MWR-SH11N	Touch Simplified Wired Remote Controller - WindFree™ (NASA)	88.00
MIM-H04EN	Wi-Fi Receiver 2.0 for NASA SPLIT/DVM IU	132.00

NB: Please check that the installation of AC071RNCDKG systems adhere to BSEN378 regulations when installed as a floor mounted unit.

R32



Floor Console

1 PHASE - R32		Cool	Heat	SEER	SCoP	Max. Fuse	Pipe size Liq, Gas	Max. pipe length (height)	LIST PRICE £
Model Reference	Description								

AC026RXADKG/EU	1ph Inverter Heat Pump R32 Outdoor	2.6kW	3.56kW	6.4	4.2	13A	1/4", 3/8"	20m (15m)	564.00
AC026RNJDKG/EU	Console Floor Standing Unit	(0.98-3.4kW)	(0.95-4.2kW)	A++	A+				315.00
MR-EH00	Wireless Remote Controller								included
								System Price	879.00

AC035RXADKG/EU	1ph Inverter Heat Pump R32 Outdoor	3.5kW	4.0kW	6.1	4.1	13A	1/4", 3/8"	20m (15m)	626.00
AC035RNJDKG/EU	Console Floor Standing Unit	(1.15-3.9kW)	(1.05-4.6kW)	A++	A+				388.00
MR-EH00	Wireless Remote Controller								included
								System Price	1,014.00

AC052RXADKG/EU	1ph Inverter Heat Pump R32 Outdoor	5.0kW	5.6kW	5.9	4.0	20A	1/4", 1/2"	30m (20m)	739.00
AC052RNJDKG/EU	Console Floor Standing Unit	(1.9-5.5kW)	(1.5-6.5kW)	A+	A+				450.00
MR-EH00	Wireless Remote Controller								included
								System Price	1,189.00

Accessories for Console LIST PRICE £

MWR-WG00JN	LCD COLOUR Wired Controller (NASA)	90.00
MWR-SH11N	Touch Simplified Wired Remote Controller - WindFree™ (NASA)	88.00
MIM-H04EN	Wi-Fi Receiver 2.0 for NASA SPLIT/DVM IU	132.00

COMMERCIAL SPLIT SYSTEM

Air Conditioner

WindFree™ High Wall

R32



11

1 PHASE - R32		Cool	Heat	SEER	SCoP	Max. Fuse	Pipe size Liq, Gas	Max. pipe length (height)	LIST PRICE £
Model Reference	Description								

AC026RXADKG/EU	1ph Inverter Heat Pump R32 Outdoor	2.6kW	3.3kW	7.0	4.1	13A	1/4", 3/8"	20m (15m)	564.00
AC026TNXDKG/EU	WindFree High Wall Mounted Unit	(0.96-4kW)	(0.75-4kW)	A++	A+				249.00
MWR-WG00JN	LCD COLOUR Wired Controller (NASA)								90.00
System Price									903.00

AC035RXADKG/EU	1ph Inverter Heat Pump R32 Outdoor	3.5kW	4.0kW	6.9	4.1	13A	1/4", 3/8"	20m (15m)	626.00
AC035TNXDKG/EU	WindFree High Wall Mounted Unit	(1-4.5kW)	(0.8-4.8kW)	A++	A+				260.00
MWR-WG00JN	LCD COLOUR Wired Controller (NASA)								90.00
System Price									976.00

AC052RXADKG/EU	1ph Inverter Heat Pump R32 Outdoor	5.0kW	6.0kW	6.9	3.9	20A	1/4", 1/2"	30m (20m)	739.00
AC052TNXDKG/EU	WindFree High Wall Mounted Unit	(1.5-6.8kW)	(1.0-6.5kW)	A++	A				335.00
MWR-WG00JN	LCD COLOUR Wired Controller (NASA)								90.00
System Price									1,164.00

AC071RXADKG/EU	1ph Inverter Heat Pump R32 Outdoor	7.1kW	8.0kW	6.8	4.0	20A	1/4", 5/8"	50m (30m)	957.00
AC071TNXDKG/EU	WindFree High Wall Mounted Unit	(2.0-8.7kW)	(1.6-9kW)	A++	A+				375.00
MWR-WG00JN	LCD COLOUR Wired Controller (NASA)								90.00
System Price									1,422.00

10kW High Wall

R32

10kW high Wall



1 PHASE - R32		Cool	Heat	SEER	SCoP	Max. Fuse	Pipe size Liq, Gas	Max. pipe length (height)	LIST PRICE £
Model Reference	Description								

AC100RXADKG/EU	1ph Inverter Heat Pump R32 Outdoor	9.5kW	10.8kW	5.9	4.0	30A	3/8", 5/8"	50m (30m)	1,295.00
AC100RNTDKG/EU	High Wall Mounted Unit	(3-11kW)	(2.2-15.5kW)	A+	A+				573.00
MWR-WG00JN	LCD COLOUR Wired Controller (NASA)								90.00
System Price									1,958.00

3 PHASE - R32		Cool	Heat	SEER	SCoP	Max. Fuse	Pipe size Liq, Gas	Max. pipe length (height)	LIST PRICE £
Model Reference	Description								

AC100RXADNG/EU	3ph Inverter Heat Pump R32 Outdoor	9.5kW	10.8kW	5.9	4.0	20A/ph	3/8", 5/8"	50m (30m)	1,367.00
AC100RNTDKG/EU	High Wall Mounted Unit	(3-11kW)	(2.2-15.5kW)	A+	A+				573.00
MWR-WG00JN	LCD COLOUR Wired Controller (NASA)								90.00
System Price									2,030.00

Accessories for Wall		LIST PRICE £
----------------------	--	--------------

MWR-WG00JN	LCD COLOUR Wired Controller (NASA)	90.00
MWR-SH11N	Touch Simplified Wired Remote Controller - WindFree™ (NASA)	88.00
AR-EH03E	WindFree & STANDARD Wireless Remote controller (SPLIT/DVM)	34.00
MIM-H04EN	NEW Wi-Fi Receiver 2.0 for NASA SPLIT/DVM IU	132.00

COMMERCIAL SPLIT SYSTEM

Air Conditioner

R32



Slim Ducted

1 PHASE - R32		Cool	Heat	SEER	SCoP	Max. Fuse	Pipe size Liq, Gas	Max. pipe length (height)	LIST PRICE £
Model Reference	Description								
AC026RXADKG/EU	1ph Inverter Heat Pump R32 Outdoor	2.6kW	3.3kW	6.2	4.0	13A	1/4", 3/8"	20m (15m)	564.00
AC026RNLDKG/EU	Slim Ducted Unit	(0.8-3.8kW)	(0.98-4.3kW)	A++	A+				353.00
MWR-WG00JN	LCD COLOUR Wired Controller (NASA)								90.00
System Price									1,007.00
AC035RXADKG/EU	1ph Inverter Heat Pump R32 Outdoor	3.5kW	4.0kW	6.1	4.0	13A	1/4", 3/8"	20m (15m)	626.00
AC035RNLDKG/EU	Slim Ducted Unit	(0.85-4.3kW)	(1-5kW)	A++	A+				365.00
MWR-WG00JN	LCD COLOUR Wired Controller (NASA)								90.00
System Price									1,081.00
AC052RXADKG/EU	1ph Inverter Heat Pump R32 Outdoor	5.0kW	6.0kW	6.1	3.9	20A	1/4", 1/2"	30m (20m)	739.00
AC052RNLDKG/EU	Slim Ducted Unit	(1.2-6.5kW)	(1.1-7.2kW)	A++	A				390.00
MWR-WG00JN	LCD COLOUR Wired Controller (NASA)								90.00
System Price									1,219.00
AC071RXADKG/EU	1ph Inverter Heat Pump R32 Outdoor	7.1kW	8.0kW	6.0	3.9	20A	1/4", 5/8"	50m (30m)	957.00
AC071RNLDKG/EU	Slim Ducted Unit	(1.5-8.7kW)	(1.9-9kW)	A+	A				415.00
MWR-WG00JN	LCD COLOUR Wired Controller (NASA)								90.00
System Price									1,462.00

Accessories for Slim Duct

LIST PRICE £

MWR-WG00JN	LCD COLOUR Wired Controller (NASA)	90.00
MWR-SH11N	Touch Simplified Wired Remote Controller - WindFree™ (NASA)	88.00
MRW-TA	Remote Temperature Sensor	22.00
AR-EH03E	WindFree Wireless Remote controller (SPLIT/DVM)	34.00
MIM-H04EN	Wi-Fi Receiver 2.0 for NASA SPLIT/DVM IU	132.00
MRK-A10N	DUCT S & Slim Duct Wireless Signal Receiver Kit (requires AR-EH03E)	33.00
MDP-E075SEE3D	Drain Pump for Slim Ducted Unit - 2.6 & 3.5 kW models	77.00
MDP-G075SP	Drain Pump for DUCT S Ducted Unit (External Assembly) - 5.6 & 7.1 kW models	72.00

COMMERCIAL SPLIT SYSTEM

Air Conditioner

R410A



Large High Static Ducted

3 PHASE - R410A		Cool	Heat	EER	CoP	Max. Fuse	Pipe size Liq, Gas	Max. pipe length (height)	LIST PRICE £
Model Reference	Description								
AC200KXAPNH/EU	3ph Inverter Heat Pump R410A Outdoor	20.0kW	23.0kW	3.1	3.5	30A/ph	3/8", 3/4"	75m (30m)	2,473.00
AC200KNHPKH/EU	Large Ducted Unit	(7.5-23kW)	(8.5-25kW)						1,584.00
MWR-WG00JN	LCD COLOUR Wired Controller (NASA)								90.00
System Price									4,147.00
AC250KXAPNH/EU	3ph Inverter Heat Pump R410A Outdoor	25.0kW	27.0kW	2.6	3.2	30A/ph	3/8", 7/8"	75m (30m)	2,789.00
AC250KNHPKH/EU	Large Ducted Unit	(6-28.5kW)	(10-32kW)						1,777.00
MWR-WG00JN	LCD COLOUR Wired Controller (NASA)								90.00
System Price									4,656.00

Accessories for Large HSP Ducted

LIST PRICE £

MWR-WG00JN	LCD COLOUR Wired Controller (NASA)	90.00
MRW-TA	Remote Temperature Sensor	22.00
MIM-H04EN	Wi-Fi Receiver 2.0 for NASA SPLIT/DVM IU	132.00
MDP-G075SP	Drain Pump for DUCT S Ducted Unit (External Assembly)	72.00

COMMERCIAL SPLIT SYSTEM

Air Conditioner

R410A

75m pipe length



High Efficiency 4way Cassette

1 PHASE - R410A										
Model Reference	Description	Cool	Heat	SEER	SCoP	Max. Fuse	Pipe size Liq, Gas	Max. pipe length (height)	LIST PRICE £	
AC071JXSCEH/EU	1ph Hi-Efficiency Inverter Heat Pump R410A	7.1kW	8.0kW	6.7	4.0	30A	3/8", 5/8"	75m (30m)	1,100.00	
AC071JN4CEH/EU	High Efficiency 4-Way Cassette (840mm)	(1.7-8.5kW)	(3-11kW)	A++	A+				537.00	
PC4NUSKEN	4-Way Cassette Fascia Panel Modern								144.00	
MWR-WG00JN	LCD COLOUR Wired Controller (NASA)								90.00	
									System Price	1,871.00

AC100JXSCEH/EU	1ph Hi-Efficiency Inverter Heat Pump R410A	10.0kW	11.2kW	7.0	4.1	40A	3/8", 5/8"	75m (30m)	1,489.00	
AC100JN4CEH/EU	High Efficiency 4-Way Cassette (840mm)	(2.2-12kW)	(3.3-17kW)	A++	A+				576.00	
PC4NUSKEN	4-Way Cassette Fascia Panel Modern								144.00	
MWR-WG00JN	LCD COLOUR Wired Controller (NASA)								90.00	
									System Price	2,299.00

3 PHASE - R410A										
Model Reference	Description	Cool	Heat	SEER	SCoP	Max. Fuse	Pipe size Liq, Gas	Max. pipe length (height)	LIST PRICE £	
AC100JXSCGH/EU	3ph Hi-Efficiency Inverter Heat Pump R410A	10.0kW	11.2kW	7.0	4.1	16A/ph	3/8", 5/8"	75m (30m)	1,573.00	
AC100JN4CEH/EU	High Efficiency 4-Way Cassette (840mm)	(2.2-12kW)	(3.3-17kW)	A++	A+				576.00	
PC4NUSKEN	4-Way Cassette Fascia Panel Modern								144.00	
MWR-WG00JN	LCD COLOUR Wired Controller (NASA)								90.00	
									System Price	2,383.00

3 PHASE - R410A										
Model Reference	Description	Cool	Heat	EER	CoP	Max. Fuse	Pipe size Liq, Gas	Max. pipe length (height)	LIST PRICE £	
AC125JXSCGH/EU	3ph Hi-Efficiency Inverter Heat Pump R410A	12.5kW	14.0kW	3.2	3.7	16A/ph	3/8", 5/8"	75m (30m)	1,740.00	
AC125JN4CEH/EU	High Efficiency 4-Way Cassette (840mm)	(2.2-14kW)	(3.3-19kW)						637.00	
PC4NUSKEN	4-Way Cassette Fascia Panel Modern								144.00	
MWR-WG00JN	LCD COLOUR Wired Controller (NASA)								90.00	
									System Price	2,611.00

Accessories for 4way Cassette										
Model Reference	Description	LIST PRICE £								
MWR-WG00JN	LCD COLOUR Wired Controller (NASA)	90.00								
PC4NUSKAN	4-Way Cassette Fascia Panel Waffle	144.00								
PC4NBSKAN	4-Way Cassette Fascia Panel Waffle - BLACK	144.00								
MSD-CAN1	S-Plasma Ion Kit for 4way & 360Cassette	65.00								
MIM-H04EN	Wi-Fi Receiver 2.0 for NASA SPLI/DVM IU	132.00								
AR-EH03E	Wireless Remote Controller	34.00								

High Efficiency MSP Ducted

75m pipe length



1 PHASE - R410A										
Model Reference	Description	Cool	Heat	SEER	SCoP	Max. Fuse	Pipe size Liq, Gas	Max. pipe length (height)	LIST PRICE £	
AC071JXSCEH/EU	1ph Hi-Efficiency Inverter Heat Pump R410A	7.1kW	8.0kW	6.1	4.0	30A	3/8", 5/8"	75m (30m)	1,100.00	
AC071JNMCEH/EU	High Efficiency MSP Duct Indoor Unit	(1.7-8.5kW)	(3-11kW)	A++	A+				489.00	
MWR-WG00JN	LCD COLOUR Wired Controller (NASA)								90.00	
									System Price	1,679.00

AC100JXSCEH/EU	1ph Hi-Efficiency Inverter Heat Pump R410A	10.0kW	11.2kW	6.7	4.1	40A	3/8", 5/8"	75m (30m)	1,489.00	
AC100JNMCEH/EU	High Efficiency MSP Duct Indoor Unit	(2.2-12kW)	(3.3-17kW)	A++	A+				614.00	
MWR-WG00JN	LCD COLOUR Wired Controller (NASA)								90.00	
									System Price	2,193.00

3 PHASE - R410A										
Model Reference	Description	Cool	Heat	SEER	SCoP	Max. Fuse	Pipe size Liq, Gas	Max. pipe length (height)	LIST PRICE £	
AC100JXSCGH/EU	3ph Hi-Efficiency Inverter Heat Pump R410A	10.0kW	11.2kW	6.7	4.1	16A/ph	3/8", 5/8"	75m (30m)	1,573.00	
AC100JNMCEH/EU	High Efficiency MSP Duct Indoor Unit	(2.2-12kW)	(3.3-17kW)	A++	A+				614.00	
MWR-WG00JN	LCD COLOUR Wired Controller (NASA)								90.00	
									System Price	2,277.00

3 PHASE - R410A										
Model Reference	Description	Cool	Heat	EER	CoP	Max. Fuse	Pipe size Liq, Gas	Max. pipe length (height)	LIST PRICE £	
AC125JXSCGH/EU	3ph Hi-Efficiency Inverter Heat Pump R410A	12.5kW	14.0kW	3.3	3.9	16A/ph	3/8", 5/8"	75m (30m)	1,740.00	
AC125JNMCEH/EU	High Efficiency MSP Duct Indoor Unit	(2.2-14kW)	(3.3-19kW)						656.00	
MWR-WG00JN	LCD COLOUR Wired Controller (NASA)								90.00	
									System Price	2,486.00

Accessories for MSP Duct										
Model Reference	Description	LIST PRICE £								
MWR-WG00JN	LCD COLOUR Wired Controller (NASA)	90.00								
MRW-TA	Remote Temperature Sensor	22.00								
MSD-EAN1	S-Plasma Ion Healthy Air Provider for Ducted	65.00								
MDP-G075SP	Drain Pump for DUCT S Ducted Unit (External Assembly)	72.00								
MDP-G075SQ	Drain Pump for DUCT S Ducted Unit (Internal Assembly)	72.00								

COMMERCIAL SPLIT SYSTEM

Air Conditioner

R410A



High Efficiency High Wall

75m pipe length

1 PHASE R410A		Cool	Heat	SEER	SCoP	Max. Fuse	Pipe size Liq, Gas	Max. pipe length (height)	LIST PRICE £	
Model Reference	Description									
AC071JXSCFH/EU	1ph Hi-Efficiency Inverter Heat Pump R410A	7.1kW	8.0kW	6.5	4.0	30A	3/8", 5/8"	75m (30m)	1,100.00	
AC071KNADEH/EU	High Efficiency Wall - Triangle	(1.7-8.5kW)	(3-11kW)	A++	A+				418.00	
MWR-WG00JN	LCD COLOUR Wired Controller (NASA)								90.00	
									System Price	1,608.00

AC100JXSCFH/EU	1ph Hi-Efficiency Inverter Heat Pump R410A	10.0kW	11.2kW	6.0	4.0	40A	3/8", 5/8"	75m (30m)	1,489.00	
AC100MNTCEH/EU	High Efficiency Wall - Rectangle	(2.2-12kW)	(3.3-17kW)	A+	A+				660.00	
MWR-WG00JN	LCD COLOUR Wired Controller (NASA)								90.00	
									System Price	2,239.00

3 PHASE R410A		Cool	Heat	SEER	SCoP	Max. Fuse	Pipe size Liq, Gas	Max. pipe length (height)	LIST PRICE £	
Model Reference	Description									
AC100JXSCGH/EU	3ph Hi-Efficiency Inverter Heat Pump R410A	10.0kW	11.2kW	6.0	4.0	16A/ph	3/8", 5/8"	75m (30m)	1,573.00	
AC100MNTCEH/EU	High Efficiency Wall - Rectangle	(2.2-12kW)	(3.3-17kW)	A+	A+				660.00	
MWR-WG00JN	LCD COLOUR Wired Controller (NASA)								90.00	
									System Price	2,323.00

Accessories for Wall		LIST PRICE £
MWR-WG00JN	LCD COLOUR Wired Controller (NASA)	90.00
MWR-SH11N	Touch Simplified Wired Remote Controller (NASA)	88.00
MIM-H04EN	Wi-Fi Receiver 2.0 for NASA SPLI/DVM IU	132.00

COMMERCIAL SPLIT SYSTEM

Air Conditioner

R410A



PAC Floor Cabinet

1 PHASE R410A		Cool	Heat	SEER	SCoP	Max. Fuse	Pipe size Liq, Gas	Max. pipe length (height)	LIST PRICE £	
Model Reference	Description									
AC100KXADEH/EU	1ph PAC Inverter Heat Pump R410A	10kW	11.2kW	5.8	4.1	25A	3/8", 5/8"	50m (30m)	1,234.00	
AC100KNPDEH/EU	PAC Floor Cabinet	(3.5-12.3kW)	(4.2-14kW)	A+	A+				552.00	
									System Price	1,786.00

3 PHASE R410A		Cool	Heat	EER	CoP	Max. Fuse	Pipe size Liq, Gas	Max. pipe length (height)	LIST PRICE £	
Model Reference	Description									
AC140KXADGH/EU	3ph PAC Inverter Heat Pump R410A	13.4kW	15.5kW	3.1	3.4	16A/ph	3/8", 5/8"	75m (30m)	1,614.00	
AC140KNPDEH/EU	PAC Floor Cabinet	(4.2-16.7kW)	(4-20kW)						626.00	
									System Price	2,240.00

NOTE: No hard-wire control option for PAC as Control Panel is incorporated

COMMERCIAL SPLIT SYSTEM

Air Conditioner



Accessories & Controls

COMMERCIAL SPLIT SYSTEM ACCESSORIES & CONTROLS

Model Reference Description

REMOTE CONTROLS

LIST PRICE £

MWR-WG00JN	LCD COLOUR PREMIUM Wired Controller (NASA)	90.00
MWR-SH11N	Touch Simplified Wired Remote Controller - WindFree™ (NASA)	88.00
AR-KH03E	360 Wireless Remote controller (SPLIT/DVM)	34.00
AR-EH03E	WindFree & STANDARD Wireless Remote controller (SPLIT/DVM)	34.00
MIM-H04EN	Wi-Fi Receiver 2.0 for NASA SPLIT/DVM IU	132.00
MRK-A10N	DUCT S & Slim Duct Wireless Signal Receiver Kit (requires AR-EH03E)	33.00

CENTRAL CONTROLS & INTERFACES

LIST PRICE £

MCM-A300N	Touch Screen Controller NASA (Centralised management of up to 128 indoor units)	609.00
MCM-A202DN	Centralised On/Off Controller NASA (maximum of 16 Group controls (maximum of 256 indoor units))	95.00
MIM-B14	External Contact Interface Module (remote on/off, unit operation/error output)	20.00
MIM-B19N	MODBUS interface Module - 1 required per system	132.00

ALTERNATIVE FASCIA PANELS

LIST PRICE £

PC1NWFMAN	WindFree 1-Way Cassette Fascia Panel - Medium	139.00
PC1NWCMAN	WindFree 1-Way Cassette Fascia Panel - Medium - PURE Filter	430.00
PC4SUFMAN	WindFree Mini 4-Way Cassette Fascia Panel - 620x620	139.00
PC4NUFMAN	WindFree 4-Way Cassette Fascia Panel	144.00
PC4NUCEAN	WindFree 4-Way Cassette Fascia Panel - PURE Filter	515.00
PC4NUXMAN	WindFree 4-Way Cassette Fascia Panel - AutoLIFT	358.00
PC4NUDMAN	360 Cassette Fascia Panel Square WHITE	144.00
PC4NUNMAN	360 Cassette Fascia Panel Round WHITE	144.00
PC4NBDMAN	360 Cassette Fascia Panel - Square BLACK	144.00
PC4NBNMAN	360 Cassette Fascia Panel - Round BLACK	144.00
PC6EUCMAN	360 Cassette Fascia Panel Square - PURE Filter	457.00
PC6EUXMAN	360 Cassette Fascia Panel Square - AutoLIFT	430.00
PC4NUSKEN	4-Way Cassette Fascia Panel Modern	144.00
PC4NUSKAN	4-Way Cassette Fascia Panel Waffle	144.00
PC4NBSKAN	4-Way Cassette Fascia Panel Waffle - BLACK	144.00

ACCESSORIES

LIST PRICE £

MCR-SMC	Motion detect sensor for 4-way Cassette (WindFree) - for 950x950 panel	66.00
MCR-SMD	Motion detect sensor for 4-way Mini Cassette (WindFree) - for 620x620 panel	66.00
MCR-SME	Motion detect sensor for 360 Cassette - for SQUARE panel	66.00
MSD-CAN1	S-Plasma Ion Healthy Air Provider for 4-Way Cassette, 360 Cassette and Ceiling	65.00
MSD-EAN1	S-Plasma Ion Healthy Air Provider for Ducted (DUCT S)	65.00
MRW-TA	Remote Temperature Sensor	22.00
MDP-G075SP	Drain Pump for DUCT S Ducted Unit (External Assembly)	72.00
MDP-G075SQ	Drain Pump for DUCT S Ducted Unit (Internal Assembly)	72.00
MDP-E075SEE3D	Drain Pump for Slim Ducted Unit - 2.6 & 3.5 kW models	77.00



COMMERCIAL MULTI SYSTEM

Air Conditioner

R32

DPM - Twin, Triple & Quad Split Systems

4 Way Mini Cassette WindFree™



DPM Systems must only be installed in the same room and with ONE remote controller

DPM - TWIN, TRIPLE & QUAD 4WAY MINI CASSETTE WindFree™ SYSTEMS R32

Reference	Indoor	Panel	Outdoor	Branch	Remote	LIST PRICE £
4way Mini W/F 7kW Twin	AC035RNNDKG/EU 284.00	x2 PC4SUFMAN 139.00	x2 AC071RXADKG/EU 957.00	MXJ-2D2509K 81.00	MWR-WG00JN 90.00	System Price 1,974.00
4way Mini W/F 10kW Twin	AC052RNNDKG/EU 335.00	x2 PC4SUFMAN 139.00	x2 AC100RXADKG/EU 1,295.00	MXJ-2D2509K 81.00	MWR-WG00JN 90.00	System Price 2,414.00
<small>*3ph option available using AC100RXADNG/EU outdoor and additional cost of £70</small>						
4way Mini W/F 10kW Triple	AC035RNNDKG/EU 284.00	x3 PC4SUFMAN 139.00	x3 AC100RXADKG/EU 1,295.00	MXJ-3D2509K 103.00	MWR-WG00JN 90.00	System Price 2,757.00
<small>*3ph option available using AC100RXADNG/EU outdoor and additional cost of £70</small>						
4way Mini W/F 12kW Triple	AC052RNNDKG/EU 335.00	x3 PC4SUFMAN 139.00	x3 AC120RXADKG/EU 1,452.00	MXJ-3D2509K 103.00	MWR-WG00JN 90.00	System Price 3,067.00
<small>*3ph option available using AC120RXADNG/EU outdoor and additional cost of £59</small>						
4way Mini W/F 12kW Quad	AC035RNNDKG/EU 284.00	x4 PC4SUFMAN 139.00	x4 AC120RXADKG/EU 1,452.00	MXJ-4D2509K 151.00	MWR-WG00JN 90.00	System Price 3,385.00
<small>*3ph option available using AC120RXADNG/EU outdoor and additional cost of £59</small>						
4way Mini W/F 14kW Twin	AC071RNNDKG/EU 418.00	x2 PC4SUFMAN 139.00	x2 AC140RXADKG/EU 1,638.00	MXJ-2D2509K 81.00	MWR-WG00JN 90.00	System Price 2,923.00
<small>*3ph option available using AC140RXADNG/EU outdoor and additional cost of £55</small>						
4way Mini W/F 14kW Triple	AC052RNNDKG/EU 335.00	x3 PC4SUFMAN 139.00	x3 AC140RXADKG/EU 1,638.00	MXJ-3D2509K 103.00	MWR-WG00JN 90.00	System Price 3,253.00
<small>*3ph option available using AC140RXADNG/EU outdoor and additional cost of £55</small>						
4way Mini W/F 14kW Quad	AC035RNNDKG/EU 284.00	x4 PC4SUFMAN 139.00	x4 AC140RXADKG/EU 1,638.00	MXJ-4D2509K 151.00	MWR-WG00JN 90.00	System Price 3,571.00
<small>*3ph option available using AC140RXADNG/EU outdoor and additional cost of £55</small>						

R410A 4 Way Mini Cassette WindFree™

DPM - TRIPLE & QUAD 4WAY MINI CASSETTE WindFree™ SYSTEMS R410A

LIST PRICE £

4way Mini W/F 20kW Triple	AC071RNNDKG/EU 418.00	x3 PC4SUFMAN 139.00	x3 AC200KXAPNH/EU 2,473.00	MXJ-3D2509K 103.00	MWR-WG00JN 90.00	System Price 4,337.00
4way Mini W/F 20kW Quad	AC052RNNDKG/EU 335.00	x4 PC4SUFMAN 139.00	x4 AC200KXAPNH/EU 2,473.00	MXJ-4D2509K 151.00	MWR-WG00JN 90.00	System Price 4,610.00
4way Mini W/F 25kW Quad	AC071RNNDKG/EU 418.00	x4 PC4SUFMAN 139.00	x4 AC250KXAPNH/EU 2,789.00	MXJ-4D2509K 151.00	MWR-WG00JN 90.00	System Price 5,258.00

COMMERCIAL MULTI SYSTEM

R32

DPM - Twin, Triple & Quad Split Systems

1 way WindFree™ Cassette

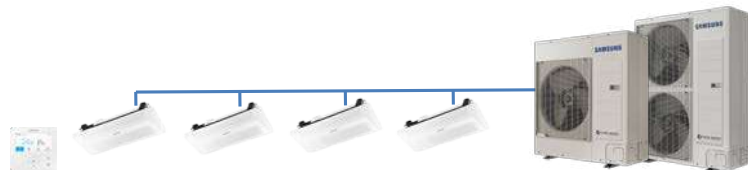

DPM Systems must only be installed in the same room and with ONE remote controller

DPM - TWIN, TRIPLE & QUAD 1WAY CASSETTE WindFree™ SYSTEMS R32

Reference	Indoor	Panel	Outdoor	Branch	Remote	LIST PRICE £
1way Cassette 7kW Twin	AC035RN1DKG/EU 396.00	x2 PC1NWFMAN 139.00	x2 AC071RXADKG/EU 957.00	MXJ-2D2509K 81.00	MWR-WG00JN 90.00	System Price 2,198.00
1way Cassette 10kW Triple	AC035RN1DKG/EU 396.00	x3 PC1NWFMAN 139.00	x3 AC100RXADKG/EU 1,295.00	MXJ-3D2509K 103.00	MWR-WG00JN 90.00	System Price 3,093.00
<small>*3ph option available using AC100RXADNG/EU outdoor and additional cost of £70</small>						
1way Cassette 12kW Quad	AC035RN1DKG/EU 396.00	x4 PC1NWFMAN 139.00	x4 AC120RXADKG/EU 1,452.00	MXJ-4D2509K 151.00	MWR-WG00JN 90.00	System Price 3,833.00
<small>*3ph option available using AC120RXADNG/EU outdoor and additional cost of £59</small>						
1way Cassette 14kW Quad	AC035RN1DKG/EU 396.00	x4 PC1NWFMAN 139.00	x4 AC140RXADKG/EU 1,638.00	MXJ-4D2509K 151.00	MWR-WG00JN 90.00	System Price 4,019.00
<small>*3ph option available using AC140RXADNG/EU outdoor and additional cost of £55</small>						

COMMERCIAL MULTI SYSTEM

R32

Air Conditioner

DPM - Twin, Triple & Quad Split Systems 4 Way Cassette WindFree™

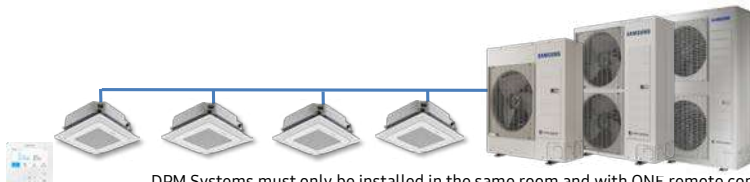

DPM Systems must only be installed in the same room and with ONE remote controller

DPM - TWIN, TRIPLE & QUAD 4WAY CASSETTE WindFree™ SYSTEMS R32

Reference	Indoor	Panel	Outdoor	Branch	Remote	LIST PRICE £
4way WindFree 10kW Twin	AC052RN4DKG/EU 462.00	x2 PC4NUFMAN 144.00	x2 AC100RXADKG/EU 1,295.00	MXJ-2D2509K 81.00	MWR-WG00JN 90.00	System Price 2,678.00
<small>*3ph option available using AC100RXADNG/EU outdoor and additional cost of £70</small>						
4way WindFree 12kW Triple	AC052RN4DKG/EU 462.00	x3 PC4NUFMAN 144.00	x3 AC120RXADKG/EU 1,452.00	MXJ-3D2509K 103.00	MWR-WG00JN 90.00	System Price 3,463.00
<small>*3ph option available using AC120RXADNG/EU outdoor and additional cost of £59</small>						
4way WindFree 14kW Twin	AC071RN4DKG/EU 476.00	x2 PC4NUFMAN 144.00	x2 AC140RXADKG/EU 1,638.00	MXJ-2D2509K 81.00	MWR-WG00JN 90.00	System Price 3,049.00
<small>*3ph option available using AC140RXADNG/EU outdoor and additional cost of £55</small>						
4way WindFree 14kW Triple	AC052RN4DKG/EU 462.00	x3 PC4NUFMAN 144.00	x3 AC140RXADKG/EU 1,638.00	MXJ-3D2509K 103.00	MWR-WG00JN 90.00	System Price 3,649.00
<small>*3ph option available using AC140RXADNG/EU outdoor and additional cost of £55</small>						

R410A 4 Way Cassette WindFree™

DPM - TWIN, TRIPLE & QUAD 4WAY CASSETTE WindFree™ SYSTEMS R410A

LIST PRICE £

4way Windfree 20kW Twin	AC100RN4DKG/EU 510.00	x2 PC4NUFMAN 144.00	x2 AC200KXAPNH/EU 2,473.00	MXJ-2D2509K 81.00	MWR-WG00JN 90.00	System Price 3,952.00
4way Windfree 20kW Triple	AC071RN4DKG/EU 476.00	x3 PC4NUFMAN 144.00	x3 AC200KXAPNH/EU 2,473.00	MXJ-3D2509K 103.00	MWR-WG00JN 90.00	System Price 4,526.00
4way Windfree 20kW Quad	AC052RN4DKG/EU 462.00	x4 PC4NUSKEN 144.00	x4 AC200KXAPNH/EU 2,473.00	MXJ-4D2509K 151.00	MWR-WG00JN 90.00	System Price 5,138.00
4way Windfree 25kW Twin	AC120RN4DKG/EU 563.00	x2 PC4NUFMAN 144.00	x2 AC250KXAPNH/EU 2,789.00	MXJ-2D2509K 81.00	MWR-WG00JN 90.00	System Price 4,374.00
4way Windfree 25kW Quad	AC071RN4DKG/EU 476.00	x4 PC4NUFMAN 144.00	x4 AC250KXAPNH/EU 2,789.00	MXJ-4D2509K 151.00	MWR-WG00JN 90.00	System Price 5,510.00

COMMERCIAL MULTI SYSTEM

R32

Air Conditioner

DPM - Twin, Triple & Quad Split Systems 360 Cassette



DPM Systems must only be installed in the same room and with ONE remote controller

DPM - TWIN, TRIPLE & QUAD 360 CASSETTE SYSTEMS R32

Reference	Indoor	Panel	Outdoor	Branch	Remote	LIST PRICE £
360 Cassette 14kW Twin	AC071RN4PKG/EU 646.00	x2 PC4NUNMAN 144.00	x2 AC140RXADKG/EU 1,638.00	MXJ-2D2509K 81.00	MWR-WG00JN 90.00	System Price 3,389.00
<small>*3ph option available using AC140RXADNG/EU outdoor and additional cost of £55</small>						

R410A 360 Cassette

DPM - TWIN, TRIPLE & QUAD 360 CASSETTE SYSTEMS R410A

LIST PRICE £

360 Cassette 20kW Twin	AC100RN4PKG/EU 687.00	x2 PC4NUNMAN 144.00	x2 AC200KXAPNH/EU 2,473.00	MXJ-2D2509K 81.00	MWR-WG00JN 90.00	System Price 4,306.00
360 Cassette 20kW Triple	AC071RN4PKG/EU 646.00	x3 PC4NUNMAN 144.00	x3 AC200KXAPNH/EU 2,473.00	MXJ-3D2509K 103.00	MWR-WG00JN 90.00	System Price 5,036.00
360 Cassette 25kW Twin	AC120RN4PKG/EU 763.00	x2 PC4NUNMAN 144.00	x2 AC250KXAPNH/EU 2,789.00	MXJ-2D2509K 81.00	MWR-WG00JN 90.00	System Price 4,774.00
360 Cassette 25kW Quad	AC071RN4PKG/EU 646.00	x4 PC4NUNMAN 144.00	x4 AC250KXAPNH/EU 2,789.00	MXJ-4D2509K 151.00	MWR-WG00JN 90.00	System Price 6,190.00

COMMERCIAL MULTI SYSTEM

Air Conditioner

R32

19

DPM - Twin, Triple & Quad Split Systems Slim Ducted



DPM Systems must only be installed in the same room and with ONE remote controller

DPM - TWIN, TRIPLE & QUAD SLIM DUCTED SYSTEMS R32

Reference	Indoor		Outdoor	Branch	Remote	LIST PRICE £
Slim Ducted 7kW Twin	AC035RNLDKG/EU 365.00	x2	AC071RXADKG/EU 957.00	MXJ-2D2509K 81.00	MWR-WG00JN 90.00	System Price 1,858.00
Slim Ducted 10kW Twin	AC052RNLDKG/EU 390.00	x2	AC100RXADKG/EU 1,295.00	MXJ-2D2509K 81.00	MWR-WG00JN 90.00	System Price 2,246.00
<small>*3ph option available using AC100RXADNG/EU outdoor and additional cost of £70</small>						
Slim Ducted 10kW Triple	AC035RNLDKG/EU 365.00	x3	AC100RXADKG/EU 1,295.00	MXJ-3D2509K 103.00	MWR-WG00JN 90.00	System Price 2,583.00
<small>*3ph option available using AC100RXADNG/EU outdoor and additional cost of £70</small>						
Slim Ducted 12kW Triple	AC052RNLDKG/EU 390.00	x3	AC120RXADKG/EU 1,452.00	MXJ-3D2509K 103.00	MWR-WG00JN 90.00	System Price 2,815.00
<small>*3ph option available using AC120RXADNG/EU outdoor and additional cost of £59</small>						
Slim Ducted 12kW Quad	AC035RNLDKG/EU 365.00	x4	AC120RXADKG/EU 1,452.00	MXJ-4D2509K 151.00	MWR-WG00JN 90.00	System Price 3,153.00
<small>*3ph option available using AC120RXADNG/EU outdoor and additional cost of £59</small>						
Slim Ducted 14kW Twin	AC071RNLDKG/EU 415.00	x2	AC140RXADKG/EU 1,638.00	MXJ-2D2509K 81.00	MWR-WG00JN 90.00	System Price 2,639.00
<small>*3ph option available using AC140RXADNG/EU outdoor and additional cost of £55</small>						
Slim Ducted 14kW Triple	AC052RNLDKG/EU 390.00	x3	AC140RXADKG/EU 1,638.00	MXJ-3D2509K 103.00	MWR-WG00JN 90.00	System Price 3,001.00
<small>*3ph option available using AC140RXADNG/EU outdoor and additional cost of £55</small>						
Slim Ducted 14kW Quad	AC035RNLDKG/EU 365.00	x4	AC140RXADKG/EU 1,638.00	MXJ-4D2509K 151.00	MWR-WG00JN 90.00	System Price 3,339.00
<small>*3ph option available using AC140RXADNG/EU outdoor and additional cost of £55</small>						

R410A Slim Ducted

DPM - TWIN, TRIPLE & QUAD DUCTED SYSTEMS R410A

						LIST PRICE £
Slim Ducted 20kW Triple	AC071RNLDKG/EU 415.00	x3	AC200KXAPNH/EU 2,473.00	MXJ-3D2509K 103.00	MWR-WG00JN 90.00	System Price 3,911.00
Slim Ducted 20kW Quad	AC052RNLDKG/EU 390.00	x4	AC200KXAPNH/EU 2,473.00	MXJ-4D2509K 151.00	MWR-WG00JN 90.00	System Price 4,274.00
Slim Ducted 25kW Quad	AC071RNLDKG/EU 415.00	x4	AC250KXAPNH/EU 2,789.00	MXJ-4D2509K 151.00	MWR-WG00JN 90.00	System Price 4,690.00

COMMERCIAL MULTI SYSTEM

Air Conditioner

R32



DPM - Twin, Triple & Quad Split Systems

MSP Duct S

DPM Systems must only be installed in the same room and with ONE remote controller

DPM - TWIN, TRIPLE & QUAD DUCT S SYSTEMS R32

Reference	Indoor	Outdoor	Branch	Remote	LIST PRICE £	
MSP Duct S 7kW Twin	AC035RNMDKG/EU 372.00	x2	AC071RXADKG/EU 957.00	MXJ-2D2509K 81.00	MWR-WG00JN 90.00	System Price 1,872.00
MSP Duct S 10kW Twin	AC052RNMDKG/EU 382.00	x2	AC100RXADKG/EU 1,295.00	MXJ-2D2509K 81.00	MWR-WG00JN 90.00	System Price 2,230.00
*3ph option available using AC100RXADNG/EU outdoor and additional cost of £72						
MSP Duct S 10kW Triple	AC035RNMDKG/EU 372.00	x3	AC100RXADKG/EU 1,295.00	MXJ-3D2509K 103.00	MWR-WG00JN 90.00	System Price 2,604.00
*3ph option available using AC100RXADNG/EU outdoor and additional cost of £72						
MSP Duct S 12kW Triple	AC052RNMDKG/EU 382.00	x3	AC120RXADKG/EU 1,452.00	MXJ-3D2509K 103.00	MWR-WG00JN 90.00	System Price 2,791.00
*3ph option available using AC120RXADNG/EU outdoor and additional cost of £61						
MSP Duct S 12kW Quad	AC035RNMDKG/EU 372.00	x4	AC120RXADKG/EU 1,452.00	MXJ-4D2509K 151.00	MWR-WG00JN 90.00	System Price 3,181.00
*3ph option available using AC120RXADNG/EU outdoor and additional cost of £61						
MSP Duct S 14kW Twin	AC071RNMDKG/EU 424.00	x2	AC140RXADKG/EU 1,638.00	MXJ-2D2509K 81.00	MWR-WG00JN 90.00	System Price 2,657.00
*3ph option available using AC140RXADNG/EU outdoor and additional cost of £56						
MSP Duct S 14kW Triple	AC052RNMDKG/EU 382.00	x3	AC140RXADKG/EU 1,638.00	MXJ-3D2509K 103.00	MWR-WG00JN 90.00	System Price 2,977.00
*3ph option available using AC140RXADNG/EU outdoor and additional cost of £56						
MSP Duct S 14kW Quad	AC035RNMDKG/EU 372.00	x4	AC140RXADKG/EU 1,638.00	MXJ-4D2509K 151.00	MWR-WG00JN 90.00	System Price 3,367.00
*3ph option available using AC140RXADNG/EU outdoor and additional cost of £56						

R410A MSP Duct S

DPM - TWIN, TRIPLE & QUAD DUCT S SYSTEMS R410A

					LIST PRICE £	
MSP Duct S 20kW Twin	AC100RNMDKG/EU 534.00	x2	AC200KXAPNH/EU 2,473.00	MXJ-2D2509K 81.00	MWR-WG00JN 90.00	System Price 3,712.00
MSP Duct S 20kW Triple	AC071RNMDKG/EU 424.00	x3	AC200KXAPNH/EU 2,473.00	MXJ-3D2509K 103.00	MWR-WG00JN 90.00	System Price 3,938.00
MSP Duct S 20kW Quad	AC052RNMDKG/EU 382.00	x4	AC200KXAPNH/EU 2,473.00	MXJ-4D2509K 151.00	MWR-WG00JN 90.00	System Price 4,242.00
MSP Duct S 25kW Twin	AC120RNMDKG/EU 571.00	x2	AC250KXAPNH/EU 2,789.00	MXJ-2D2509K 81.00	MWR-WG00JN 90.00	System Price 4,102.00
MSP Duct S 25kW Quad	AC071RNMDKG/EU 424.00	x4	AC250KXAPNH/EU 2,789.00	MXJ-4D2509K 151.00	MWR-WG00JN 90.00	System Price 4,726.00

COMMERCIAL MULTI SYSTEM

Air Conditioner

R32

21

DPM - Twin, Triple & Quad Split Systems Wall WindFree™

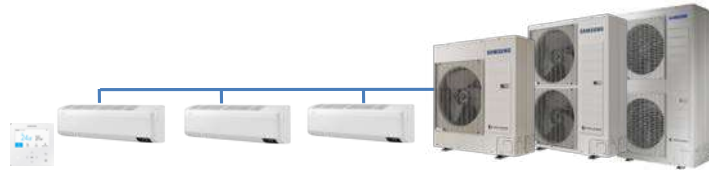

DPM Systems must only be installed in the same room and with ONE remote controller

DPM - TWIN, TRIPLE & QUAD WALL SYSTEMS R32

Reference	Indoor		Outdoor	Branch	Remote	LIST PRICE £
Wall WindFree 7kW Twin	AC052TNXDKG/EU 260.00	x 2	AC071RXADKG/EU 957.00	MXJ-2D2509K 81.00	MWR-WG00JN 90.00	System Price 1,648.00
Wall WindFree 10kW Twin	AC052TNXDKG/EU 335.00	x 2	AC100RXADKG/EU 1,295.00	MXJ-2D2509K 81.00	MWR-WG00JN 90.00	System Price 2,136.00
*3ph option available using AC100RXADNG/EU outdoor and additional cost of £72						
Wall WindFree 10kW Triple	AC052TNXDKG/EU 260.00	x 3	AC100RXADKG/EU 1,295.00	MXJ-3D2509K 103.00	MWR-WG00JN 90.00	System Price 2,268.00
*3ph option available using AC100RXADNG/EU outdoor and additional cost of £72						
Wall WindFree 12kW Triple	AC052TNXDKG/EU 335.00	x 3	AC120RXADKG/EU 1,452.00	MXJ-3D2509K 103.00	MWR-WG00JN 90.00	System Price 2,650.00
*3ph option available using AC120RXADNG/EU outdoor and additional cost of £61						
Wall WindFree 12kW Quad	AC052TNXDKG/EU 260.00	x 4	AC120RXADKG/EU 1,452.00	MXJ-4D2509K 151.00	MWR-WG00JN 90.00	System Price 2,733.00
*3ph option available using AC120RXADNG/EU outdoor and additional cost of £61						
Wall WindFree 14kW Twin	AC071TNXDKG/EU 375.00	x 2	AC140RXADKG/EU 1,638.00	MXJ-2D2509K 81.00	MWR-WG00JN 90.00	System Price 2,559.00
*3ph option available using AC140RXADNG/EU outdoor and additional cost of £56						
Wall WindFree 14kW Triple	AC052TNXDKG/EU 335.00	x 3	AC140RXADKG/EU 1,638.00	MXJ-3D2509K 103.00	MWR-WG00JN 90.00	System Price 2,836.00
*3ph option available using AC140RXADNG/EU outdoor and additional cost of £56						
Wall WindFree 14kW Quad	AC052TNXDKG/EU 260.00	x 4	AC140RXADKG/EU 1,638.00	MXJ-4D2509K 151.00	MWR-WG00JN 90.00	System Price 2,919.00
*3ph option available using AC140RXADNG/EU outdoor and additional cost of £56						

R410A Wall WindFree™

DPM - TWIN, TRIPLE & QUAD WALL SYSTEMS R410A

LIST PRICE £

Wall WindFree 20kW Triple	AC071TNXDKG/EU 375.00	x 3	AC200KXAPNH/EU 2,473.00	MXJ-3D2509K 103.00	MWR-WG00JN 90.00	System Price 3,791.00
Wall WindFree 20kW Quad	AC052TNXDKG/EU 335.00	x 4	AC200KXAPNH/EU 2,473.00	MXJ-4D2509K 151.00	MWR-WG00JN 90.00	System Price 4,054.00
Wall WindFree 25kW Quad	AC071TNXDKG/EU 375.00	x 4	AC250KXAPNH/EU 2,789.00	MXJ-4D2509K 151.00	MWR-WG00JN 90.00	System Price 4,530.00



Wall Large 20kW Twin	AC100RNTDKG/EU 573.00	x 2	AC200KXAPNH/EU 2,473.00	MXJ-2D2509K 81.00	MWR-WG00JN 90.00	System Price 3,790.00
-------------------------	--------------------------	-----	----------------------------	----------------------	---------------------	--------------------------

COMMERCIAL MULTI SYSTEM **R32**

Air Conditioner

DPM - Twin, Triple & Quad Split Systems

Ceiling

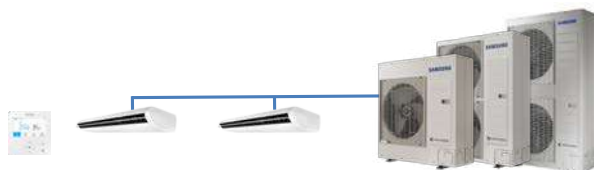

DPM Systems must only be installed in the same room and with ONE remote controller

DPM - TWIN, TRIPLE & QUAD CEILING SYSTEMS R32

Reference	Indoor	Outdoor	Branch	Remote	LIST PRICE £	
Ceiling 10kW Twin	AC052RNC DKG/EU 400.00	x 2	AC100RXADKG/EU 1,295.00	MXJ-2D2509K 81.00	MWR-WG00JN 90.00	System Price 2,266.00
<small>*3ph option available using AC100RXADNG/EU outdoor and additional cost of £72</small>						
Ceiling 12kW Triple	AC052RNC DKG/EU 400.00	x 3	AC120RXADKG/EU 1,452.00	MXJ-3D2509K 103.00	MWR-WG00JN 90.00	System Price 2,845.00
<small>*3ph option available using AC120RXADNG/EU outdoor and additional cost of £61</small>						
Ceiling 14kW Twin	AC071RNC DKG/EU 406.00	x 2	AC140RXADKG/EU 1,638.00	MXJ-2D2509K 81.00	MWR-WG00JN 90.00	System Price 2,621.00
<small>*3ph option available using AC140RXADNG/EU outdoor and additional cost of £56</small>						
Ceiling 14kW Triple	AC052RNC DKG/EU 400.00	x 3	AC140RXADKG/EU 1,638.00	MXJ-3D2509K 103.00	MWR-WG00JN 90.00	System Price 3,031.00
<small>*3ph option available using AC140RXADNG/EU outdoor and additional cost of £56</small>						

R410A Ceiling**DPM - TWIN, TRIPLE & QUAD CEILING SYSTEMS R410A**

LIST PRICE £

Ceiling 20kW Twin	AC100RNC DKG/EU 913.00	x 2	AC200KXAPNH/EU 2,473.00	MXJ-2D2509K 81.00	MWR-WG00JN 90.00	System Price 4,470.00
Ceiling 20kW Triple	AC071RNC DKG/EU 406.00	x 3	AC200KXAPNH/EU 2,473.00	MXJ-3D2509K 103.00	MWR-WG00JN 90.00	System Price 3,884.00
Ceiling 20kW Quad	AC052RNC DKG/EU 400.00	x 4	AC200KXAPNH/EU 2,473.00	MXJ-4D2509K 151.00	MWR-WG00JN 90.00	System Price 4,314.00
Ceiling 25kW Twin	AC120RNC DKG/EU 1,005.00	x 2	AC250KXAPNH/EU 2,789.00	MXJ-2D2509K 81.00	MWR-WG00JN 90.00	System Price 4,970.00
Ceiling 25kW Quad	AC071RNC DKG/EU 406.00	x 4	AC250KXAPNH/EU 2,789.00	MXJ-4D2509K 151.00	MWR-WG00JN 90.00	System Price 4,654.00

COMMERCIAL MULTI SYSTEM

Air Conditioner

DPM - Twin, Triple & Quad Split Systems



DPM Limitations

	R32		R410A
	7,10 & 12kW OU	14kW OU	20 & 25kW OU
Total Pipe length (all lengths combined)	50m	75m	75m
Max. Main pipe length (L ₁)	30m	50m	75m
Max. Leg length after branch pipe	15m		
Max. difference between leg length (e.g. L ₂ -L ₃)	5m		
Max. distance between Indoor units (D)	10m		
Max. height between Indoors & outdoor (h ₁)	30m		
Max. height difference between Indoors (h ₂)	0.5m		

* Indoor units should be installed in one area which is not divided by a wall & controlled via 1 remote

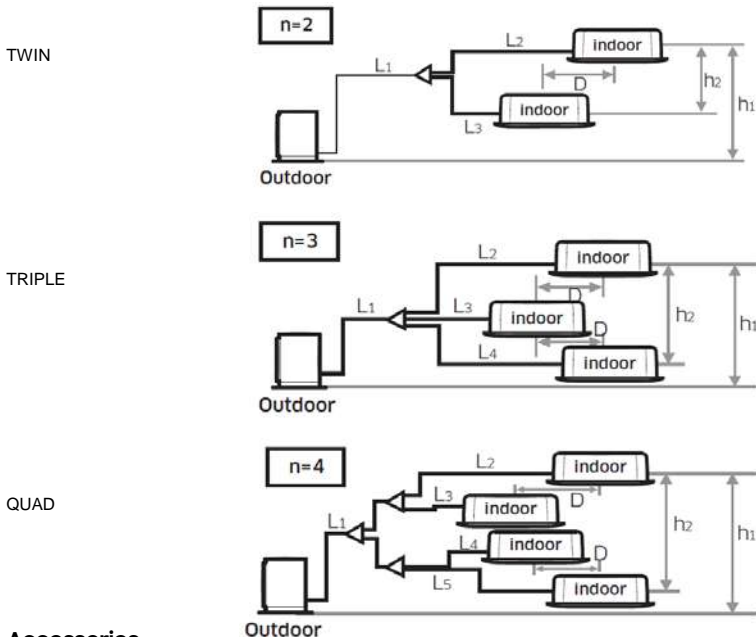

Accessories

DPM ACCESSORIES

Model Reference	Description	LIST PRICE £
MXJ-2D2509K	2-Way Branch Pipe Kit for DPM TWIN systems	81.00
MXJ-3D2509K	3-Way Branch Pipe Kit for DPM TRIPLE systems	103.00
MXJ-4D2509K	4-Way Branch Pipe Kit for DPM QUAD systems	151.00
MWR-WG00JN	LCD COLOUR Wired Controller (NASA)	90.00
MCM-A300N	Touch Screen Controller NASA (Centralised management of up to 128 indoor units)	609.00
MIM-B14	External Contact Interface Module (remote on/off, unit operation/error output)	20.00
MIM-B19N	MODBUS interface Module - 1 required per system	132.00
PC1NWFMAN	WindFree 1-Way Cassette Fascia Panel - Medium	139.00
PC1NWCMAN	WindFree 1-Way Cassette Fascia Panel - Medium - PURE Filter	430.00
PC4SUFMAN	WindFree Mini 4-Way Cassette Fascia Panel - 620x620	139.00
PC4NUFMAN	WindFree 4-Way Cassette Fascia Panel	144.00
PC4NUCEAN	WindFree 4-Way Cassette Fascia Panel - PURE Filter	515.00
PC4NUXMAN	WindFree 4-Way Cassette Fascia Panel - AutoLIFT	358.00
PC4NUDMAN	360 Cassette Fascia Panel Square	144.00
PC4NUNMAN	360 Cassette Fascia Panel Round	144.00
PC4NBDMAN	360 Cassette Fascia Panel - Square BLACK	144.00
PC4NBNMAN	360 Cassette Fascia Panel - Round BLACK	144.00
PC6EUCMAN	360 Cassette Fascia Panel Square - PURE Filter	457.00
PC6EUXMAN	360 Cassette Fascia Panel Square - AutoLIFT	430.00
MSD-CAN1	S-Plasma Ion Healthy Air Provider for 4-Way Cassette, 360 Cassette and Ceiling	65.00
MSD-EAN1	S-Plasma Ion Healthy Air Provider for Ducted (Duct S)	65.00
MDP-G075SP	Drain Pump for DUCT S Ducted Unit (External Assembly)	72.00
MDP-G075SQ	Drain Pump for DUCT S Ducted Unit (Internal Assembly)	72.00
MDP-E075SEE3D	Drain Pump for Slim Ducted Unit - 2.6 & 3.5kW models (use MDP-G075SP for other Slim Ducted models)	77.00

Free Joint Multi



FJM - Outdoor Units

OUTDOOR UNITS ~ 1 PHASE R32							LIST PRICE £
Model Reference	Type	Cool	Heat	Max. Fuse	Total Pipe length	Description	
(*max. pipe length per leg)							
AJ040TXJ2KG/EU	2 Port	4.0kW	4.4kW	10A	30m (*20m)	Inverter Heat Pump R32 1 Phase	823.00
AJ050TXJ2KG/EU	2 Port	5.0kW	5.7kW	13A	30m (*20m)	Inverter Heat Pump R32 1 Phase	904.00
AJ052TXJ3KG/EU	3 Port	5.2kW	6.3kW	13A	50m (*25m)	Inverter Heat Pump R32 1 Phase	1,279.00
AJ068TXJ3KG/EU	3 Port	6.8kW	8.0kW	20A	50m (*25m)	Inverter Heat Pump R32 1 Phase	1,366.00
AJ080TXJ4KG/EU	4 Port	8.0kW	9.3kW	20A	70m (*25m)	Inverter Heat Pump R32 1 Phase	1,598.00
AJ100TXJ5KG/EU	5 Port	10.0kW	12.0kW	25A	75m (*25m)	Inverter Heat Pump R32 1 Phase	1,962.00

NB: The R32 Console unit may not adhere to BSEN378 regulations when applied to outdoor units >6kW - please contact Samsung for more information

FJM - Indoor Units

MULTI WALL UNITS			Pipe size		LIST PRICE £
Model Reference	Cool	Heat	Liq, Gas	Description	

LUZON - Easy Filter Plus

AR07TXHZAWKNEU	2.0kW	2.2kW	1/4", 3/8"	Luzon High Wall Mounted Unit	188.00
AR09TXHZAWKNEU	2.5kW	3.2kW	1/4", 3/8"	Luzon High Wall Mounted Unit	203.00
AR12TXHZAWKNEU	3.5kW	4.0kW	1/4", 3/8"	Luzon High Wall Mounted Unit	225.00
AR18TXHZAWKNEU	5.0kW	6.0kW	1/4", 1/2"	Luzon High Wall Mounted Unit	347.00
AR24TXHZAWKNEU	6.5kW	7.4kW	1/4", 5/8"	Luzon High Wall Mounted Unit	458.00



CEBU - Wi-Fi & Easy Filter Plus

AR07TXFYAWKNEU	2.0kW	2.2kW	1/4", 3/8"	Cebu High Wall Mounted Unit	207.00
AR09TXFYAWKNEU	2.5kW	3.2kW	1/4", 3/8"	Cebu High Wall Mounted Unit	224.00
AR12TXFYAWKNEU	3.5kW	4.0kW	1/4", 3/8"	Cebu High Wall Mounted Unit	247.00
AR18TXFYAWKNEU	5.0kW	6.0kW	1/4", 1/2"	Cebu High Wall Mounted Unit	382.00
AR24TXFYAWKNEU	6.5kW	7.4kW	1/4", 5/8"	Cebu High Wall Mounted Unit	504.00



COMFORT WindFree™ Wi-Fi & Easy Filter Plus

AR07TXFCAWKNEU	2.0kW	2.2kW	1/4", 3/8"	Comfort WindFree High Wall Mounted Unit	258.00
AR09TXFCAWKNEU	2.5kW	3.2kW	1/4", 3/8"	Comfort WindFree High Wall Mounted Unit	282.00
AR12TXFCAWKNEU	3.5kW	4.0kW	1/4", 3/8"	Comfort WindFree High Wall Mounted Unit	305.00
AR18TXFCAWKNEU	5.0kW	6.0kW	1/4", 1/2"	Comfort WindFree High Wall Mounted Unit	411.00
AR24TXFCAWKNEU	6.5kW	7.4kW	1/4", 5/8"	Comfort WindFree High Wall Mounted Unit	560.00



AVANT WindFree™ Wi-Fi & Tri-Care Filter

AR07TXEAAWKNEU	2.0kW	2.2kW	1/4", 3/8"	Avant WindFree High Wall Mounted Unit	297.00
AR09TXEAAWKNEU	2.5kW	3.2kW	1/4", 3/8"	Avant WindFree High Wall Mounted Unit	327.00
AR12TXEAAWKNEU	3.5kW	4.0kW	1/4", 3/8"	Avant WindFree High Wall Mounted Unit	357.00
AR18TXEAAWKNEU	5.0kW	6.0kW	1/4", 1/2"	Avant WindFree High Wall Mounted Unit	492.00
AR24TXEAAWKNEU	6.5kW	7.4kW	1/4", 5/8"	Avant WindFree High Wall Mounted Unit	653.00



ELITE WindFree™ Wi-Fi, Tri-Care Filter & Motion Detection Sensor

AR07TXCAAWKNEU	2.0kW	2.2kW	1/4", 3/8"	Elite WindFree High Wall Mounted Unit	327.00
AR09TXCAAWKNEU	2.5kW	3.2kW	1/4", 3/8"	Elite WindFree High Wall Mounted Unit	376.00
AR12TXCAAWKNEU	3.5kW	4.0kW	1/4", 3/8"	Elite WindFree High Wall Mounted Unit	410.00



PLEASE NOTE: Please see the allowed combination table in FJM TDB, for compatibility confirmation between outdoor/indoor models
Previous FJM version indoor/outdoor units are NOT compatible with NASA protocol models listed on this page

*Above Wall Mounted indoor units require MIM-A00N interface for connection to wired controller

Free Joint Multi

Mini Multi Split Systems

R32

25

FJM - Indoor Units

MULTI CONSOLE FLOOR, DUCTED & CASSETTE UNITS				Pipe size	Description	LIST PRICE £
Model Reference	Cool	Heat	Liq, Gas			

Floor



AJ026TNJDKG/EU	2.6kW	2.9kW	1/4", 3/8"	Console Floor Standing Unit	352.00
AJ035TNJDKG/EU	3.5kW	3.8kW	1/4", 3/8"	Console Floor Standing Unit	394.00
AJ052TNJDKG/EU	5.2kW	5.6kW	1/4", 1/2"	Console Floor Standing Unit	460.00

NB: The R32 Console unit may not adhere to BSEN378 regulations when applied to outdoor units >6kW - please contact Samsung for more information

Ducted



AJ026TNLDEG/EU	2.6kW	2.9kW	1/4", 3/8"	Slimline Ducted Unit	403.00
AJ035TNLDEG/EU	3.5kW	3.8kW	1/4", 3/8"	Slimline Ducted Unit	435.00
AJ052TNMDEG/EU	5.2kW	6.0kW	1/4", 1/2"	MSP Ducted Unit	503.00

AJ026TNLPEG/EU	2.6kW	2.9kW	1/4", 3/8"	Slimline Ducted Unit - With PUMP	430.00
AJ035TNLPEG/EU	3.5kW	3.8kW	1/4", 3/8"	Slimline Ducted Unit - With PUMP	462.00

WindFree™ 4way Mini cassette



AJ016TNNDKG/EU	1.6kW	1.8kW	1/4", 3/8"	WindFree 4-Way Mini Cassette	328.00
AJ020TNNDKG/EU	2.0kW	2.2kW	1/4", 3/8"	WindFree 4-Way Mini Cassette	346.00
AJ026TNNDKG/EU	2.5kW	3.2kW	1/4", 3/8"	WindFree 4-Way Mini Cassette	364.00
AJ035TNNDKG/EU	3.5kW	3.8kW	1/4", 3/8"	WindFree 4-Way Mini Cassette	397.00
AJ052TNNDKG/EU	5.2kW	5.6kW	1/4", 1/2"	WindFree 4-Way Mini Cassette	448.00
PC4SUFMAN				WindFree Mini 4-Way Cassette Fascia Panel	139.00

WindFree™ 1way cassette



AJ026TN1DKG/EU	2.6kW	2.9kW	1/4", 3/8"	WindFree 1-Way Cassette	322.00
AJ035TN1DKG/EU	3.5kW	3.8kW	1/4", 3/8"	WindFree 1-Way Cassette	392.00
PC1NWFMAN				WindFree 1-Way Cassette Fascia Panel	139.00

PLEASE NOTE: Please see the allowed combination table in FJM TDB, for compatibility confirmation between outdoor/indoor models
Previous FJM version indoor/outdoor units are NOT compatible with NASA protocol models listed on this page

FJM - Accessories

FJM ACCESSORIES		LIST PRICE £
Model Reference	Description	

MWR-WG00JN	LCD COLOUR PREMIUM Wired Controller (NASA)	90.00
MWR-SH11N	Simplified Wired Remote Controller	88.00
AR-EH03E	WindFree & STANDARD Wireless Remote controller (SPLIT/DVM)	34.00
MIM-H04EN	Wi-Fi Receiver 2.0 FJM/CAC/DVM NASA	132.00
MIM-B14	External Contact Interface Module (remote on/off, unit operation/error output)	20.00
MIM-A00N	Interface to connect NASA wired remote controller to RAC High Wall (Check suitability)	23.00
MIM-R10N	Interface to connect RAC High Wall to Central Control network (Check outdoor suitability)	166.00
MRK-A10N	DUCT S & Slim Duct Wireless Signal Receiver Kit (requires AR-EH03E)	33.00
MRW-TA	Remote Temperature Sensor	22.00
MCM-A300N	Touch Screen Controller NASA (Centralised management of up to 128 indoor units)	609.00
MDP-M075SGU3D	Drain Pump for MSP Ducted Unit (TNM Model)	72.00

* FJM Wall Mounted indoor units require MIM-A00N interface for connection to wired controller

ERV & ERVPLUS

Heat Recovery Ventilator



Air to Air Heat Exchangers

ERV HEAT RECOVERY VENTILATION UNITS - 1 phase								
Model Reference	Description	Air Volume	Max Fuse		Rated ESP	Duct Dia	LIST PRICE £	
AN026JSKLN/EU	Air to Air Heat Exchanger	260m³/h	6A		100Pa	150mm	821.00	
AN035JSKLN/EU	Air to Air Heat Exchanger	350m³/h	6A		155Pa	200mm	1,032.00	
AN050JSKLN/EU	Air to Air Heat Exchanger	500m³/h	6A		165Pa	200mm	1,082.00	
AN080JSKLN/EU	Air to Air Heat Exchanger	800m³/h	6A		155Pa	250mm	1,479.00	
AN100JSKLN/EU	Air to Air Heat Exchanger	1000m³/h	6A		155Pa	250mm	1,745.00	
MOS-P1050	Differential Pressure Switch	MUST BE ORDERED WITH ABOVE TO COMPLY WITH ERP REGULATIONS						88.00



DVM Air to Air Heat Exchangers - with coil

DVM S ERV PLUS HEAT RECOVERY VENTILATION UNITS (with DX coil)								
Model Reference	Description	Air Volume	Max Fuse	Pipe Sizes	Rated ESP	Duct Dia	LIST PRICE £	
AM050FNKDEH/EU	Heat Exchanger with coil for VRF	500m³/h	6A	1/4", 1/2"	160Pa	200mm	1,480.00	
AM100FNKDEH/EU	Heat Exchanger with coil for VRF	1000m³/h	6A	1/4", 1/2"	150Pa	250mm	2,385.00	
MOS-P1050	Differential Pressure Switch	MUST BE ORDERED WITH ABOVE TO COMPLY WITH ERP REGULATIONS						88.00

ERV/ERV PLUS ACCESSORIES			LIST PRICE £
Model Reference	Description		
MWR-WG00JN	LCD COLOUR PREMIUM Wired Controller (NASA)		90.00
MWR-VH12N	NEW ERV Wired Remote Controller (AN***JSKLN)		41.00
MSD-EAN1	S-Plasma Ion Kit		65.00
MOS-C1	Carbon Dioxide Sensor		123.00
MIM-N10	NEW ERV Communication Protocol Converter - Needed if Central control interface is required		166.00
MOS-P1050	Differential Pressure Switch	MUST BE ORDERED WITH ABOVE TO COMPLY WITH ERP REGULATIONS	

DVM S DIGITAL VARIABLE MULTI AHU

Air Handling Unit Kits

DVM S AHU CONNECTION KITS			
Model Reference	Description	HP	LIST PRICE £
MXD-K025AN	Air Handling Unit Connection Kit (2.5HP)	2.5	649.00
MXD-K050AN	Air Handling Unit Connection Kit (5.0HP)	5.0	690.00
MXD-K075AN	Air Handling Unit Connection Kit (7.5HP)	7.5	771.00
MXD-K100AN	Air Handling Unit Connection Kit (10.0HP)	10.0	812.00
SOLUTIONS For Capacities >10hp on same refrigeration system - use up to 4 x MXD-A64100E per control kit			
MXD-A64K100E	AHU EEV Kit (10HP) for use with MCM-D201N	10.0	123.00
MCM-D201N	Control Kit for MXD-A64K100E		287.00



COMMERCIAL SPLIT SYSTEM

AHU

Air Handling Unit Kit

CAC AHU CONNECTION KITS			
Model Reference	Description	HP	LIST PRICE £
MXD-K100XN	SPLIT Air Handling Unit Connection Kit (4-10.0HP) - 10kw to 25kW	4-10HP	613.00

NOTE: For use with R410A Commercial Split System outdoor units ONLY, see below:

Model	Capacity	LIST PRICE £
AC100KXADEH/EU	10kW	1,234.00
AC140KXADGH/EU	14kW	1,614.00
AC200KXAPNH/EU	20kW	2,473.00
AC250KXAPNH/EU	25kW	2,789.00



DVM S ECO

Digital Variable Multi

DVM - Mini VRF



DVM S ECO HEAT PUMP OUTDOOR UNITS ~ 1 PHASE

Model Reference	Type	HP	Cool	Heat	EER	CoP	Description	LIST PRICE £
SINGLE FAN								
AM040KXMDER/EU	2-Pipe	4	12.1kW	12.1kW	3.36	4.17	DVM S Mini Inverter Heat Pump R410A 1 Phase	2,488.00
AM050KXMDER/EU	2-Pipe	5	14.0kW	14.0kW	3.50	4.12	DVM S Mini Inverter Heat Pump R410A 1 Phase	2,809.00

DVM - Mini VRF - Heat Pump / Heat Recovery

3pipe Mini VRF



DVM S ECO HEAT PUMP/HEAT RECOVERY OUTDOOR UNITS ~ 1 PHASE

Model Reference	Type	HP	Cool	Heat	EER	CoP	Description	LIST PRICE £
2pipe/3pipe								
AM040NXMDER/EU	2 / 3 Pipe	4	12.1kW	12.1kW	4.50	4.80	DVM S Mini Inverter HP/HR R410A 1 Phase	2,746.00
AM050NXMDER/EU	2 / 3 Pipe	5	14.0kW	14.0kW	4.11	4.70	DVM S Mini Inverter HP/HR R410A 1 Phase	3,100.00
AM060NXMDER/EU	2 / 3 Pipe	6	15.5kW	15.5kW	3.75	4.45	DVM S Mini Inverter HP/HR R410A 1 Phase	3,454.00

DVM S ECO HEAT PUMP/HEAT RECOVERY OUTDOOR UNITS ~ 3 PHASE

2pipe/3pipe								
AM040NXMDGR/EU	2 / 3 Pipe	4	12.1kW	12.1kW	4.50	4.80	DVM S Mini Inverter HP/HR R410A 3 Phase	2,922.00
AM050NXMDGR/EU	2 / 3 Pipe	5	14.0kW	14.0kW	4.11	4.70	DVM S Mini Inverter HP/HR R410A 3 Phase	3,364.00
AM060NXMDGR/EU	2 / 3 Pipe	6	15.5kW	15.5kW	3.75	4.45	DVM S Mini Inverter HP/HR R410A 3 Phase	3,806.00

#3pipe HR function via MCU boxes - At least 1x Master MCU HR required per system



DVM - Mini VRF Large Capacity

DVM S ECO HEAT PUMP OUTDOOR UNITS ~ 3 PHASE

Model Reference	Type	HP	Cool	Heat*	EER	CoP	Description	LIST PRICE £
AM080FXMDGH/EU	2-Pipe	8	22.4kW	25.0kW	3.92	5.12	DVM S Mini Inverter Heat Pump R410A 3 Phase	4,779.00
AM100KXMDGH/EU	2-Pipe	10	28.0kW	31.5kW	3.84	4.67	DVM S Mini Inverter Heat Pump R410A 3 Phase	5,250.00
AM120KXMDGH/EU	2-Pipe	12	33.5kW	37.5kW	3.82	4.79	DVM S Mini Inverter Heat Pump R410A 3 Phase	6,194.00
AM140KXMDGH/EU	2-Pipe	14	40.0kW	45.0kW	3.78	4.55	DVM S Mini Inverter Heat Pump R410A 3 Phase	7,308.00

*Maximum Heating capacity - a rated heating capacity is detailed in relevant catalogue and Technical Data Book.

NOTE: Updated DVM S Eco models will be launched in June 2022, specification will be similar, prices will be same. Details to follow.

DVM S WATER

Digital Variable Multi

DVM - Water Cooled VRF - Heat Pump / Heat Recovery



DVM S WATER CONDENSING UNITS HP & HR ~ 3 PHASE

Model Reference	Type	HP	Cool	Heat*	EER	CoP	Description	LIST PRICE £
2pipe/3pipe								
AM080MXWANR/EU	2 / 3 Pipe	8	22.4kW	25.2kW	6.10	6.35	DVM S Water Inverter HP/HR R410A 3 Phase	6,274.00
AM100MXWANR/EU	2 / 3 Pipe	10	28.0kW	31.5kW	5.75	6.25	DVM S Water Inverter HP/HR R410A 3 Phase	7,376.00
AM120MXWANR/EU	2 / 3 Pipe	12	33.6kW	37.8kW	5.60	6.05	DVM S Water Inverter HP/HR R410A 3 Phase	8,817.00
AM200MXWANR/EU	2 / 3 Pipe	20	39.2kW	44.1kW	5.20	5.80	DVM S Water Inverter HP/HR R410A 3 Phase	13,395.00
AM300KXWANR/EU	2 / 3 Pipe	30	84.0kW	94.5kW	5.00	5.60	DVM S Water Inverter HP/HR R410A 3 Phase	19,466.00

NB: Not for outdoor installation

*Maximum Heating capacity - a rated heating capacity is detailed in relevant catalogue and Technical Data Book.

#3pipe HR function via MCU boxes



DVMS2 - 3pipe Heat Recovery

NEW model

HIGH EFFICIENCY HR MODEL

DVMS2 HE HEAT RECOVERY OUTDOOR UNITS ~ 3 PHASE

Model Reference	Type	HP	Cool	Heat*	SEER	SCoP	Description	LIST PRICE £
AM080AXVGGR/EU	3-Pipe	8	22.4kW	25.2kW	7.20	4.50	DVMS2 High Efficiency Heat Recovery Inverter R410A	6,022.00
AM100AXVGGR/EU	3-Pipe	10	28.0kW	31.5kW	6.90	4.40	DVMS2 High Efficiency Heat Recovery Inverter R410A	6,753.00
AM120AXVGGR/EU	3-Pipe	12	33.6kW	37.8kW	6.90	4.56	DVMS2 High Efficiency Heat Recovery Inverter R410A	8,123.00
AM140AXVGGR/EU	3-Pipe	14	40.0kW	45.0kW	6.70	4.25	DVMS2 High Efficiency Heat Recovery Inverter R410A	9,398.00
AM160AXVGGR/EU	3-Pipe	16	45.0kW	50.4kW	6.90	4.30	DVMS2 High Efficiency Heat Recovery Inverter R410A	11,130.00
AM180AXVGGR/EU	3-Pipe	18	50.4kW	56.7kW	7.50	4.80	DVMS2 High Efficiency Heat Recovery Inverter R410A	12,316.00
AM200AXVGGR/EU	3-Pipe	20	56.0kW	63.0kW	6.50	4.50	DVMS2 High Efficiency Heat Recovery Inverter R410A	13,502.00
AM220AXVGGR/EU	3-Pipe	22	61.6kW	69.3kW	6.20	4.30	DVMS2 High Efficiency Heat Recovery Inverter R410A	14,871.00
AM240AXVGGR/EU	3-Pipe	24	67.2kW	75.6kW	5.90	3.90	DVMS2 High Efficiency Heat Recovery Inverter R410A	16,271.00
AM260AXVGGR/EU	3-Pipe	26	72.8kW	81.9kW	5.40	3.90	DVMS2 High Efficiency Heat Recovery Inverter R410A	17,268.00

*Maximum Heating capacity - a rated heating capacity is detailed in relevant catalogue and Technical Data Book.

#3pipe HR function via MCU boxes



DVMS2 - 2pipe Heat Pump

NEW model

HIGH EFFICIENCY HP MODEL

DVMS2 HE HEAT PUMP OUTDOOR UNITS ~ 3 PHASE

Model Reference	Type	HP	Cool	Heat*	SEER	SCoP	Description	LIST PRICE £
AM080AXVGGH/EU	2-Pipe	8	22.4kW	25.2kW	7.20	4.50	DVMS2 High Efficiency Heat Pump Inverter R410A	5,404.00
AM100AXVGGH/EU	2-Pipe	10	28.0kW	31.5kW	6.90	4.40	DVMS2 High Efficiency Heat Pump Inverter R410A	5,902.00
AM120AXVGGH/EU	2-Pipe	12	33.6kW	37.8kW	6.90	4.56	DVMS2 High Efficiency Heat Pump Inverter R410A	7,175.00
AM140AXVGGH/EU	2-Pipe	14	40.0kW	45.0kW	6.70	4.25	DVMS2 High Efficiency Heat Pump Inverter R410A	8,575.00
AM160AXVGGH/EU	2-Pipe	16	45.0kW	50.4kW	6.90	4.30	DVMS2 High Efficiency Heat Pump Inverter R410A	10,127.00
AM180AXVGGH/EU	2-Pipe	18	50.4kW	56.7kW	7.50	4.80	DVMS2 High Efficiency Heat Pump Inverter R410A	10,948.00
AM200AXVGGH/EU	2-Pipe	20	56.0kW	63.0kW	6.50	4.50	DVMS2 High Efficiency Heat Pump Inverter R410A	12,456.00
AM220AXVGGH/EU	2-Pipe	22	61.6kW	69.3kW	6.20	4.30	DVMS2 High Efficiency Heat Pump Inverter R410A	13,859.00
AM240AXVGGH/EU	2-Pipe	24	67.2kW	75.6kW	5.90	3.90	DVMS2 High Efficiency Heat Pump Inverter R410A	14,627.00
AM260AXVGGH/EU	2-Pipe	26	72.8kW	81.9kW	5.40	3.90	DVMS2 High Efficiency Heat Pump Inverter R410A	15,524.00

*Maximum Heating capacity - a rated heating capacity is detailed in relevant catalogue and Technical Data Book.



DVM - 2pipe Heat Pump

NEW model

STANDARD HP MODEL

DVMS2 STD HEAT PUMP OUTDOOR UNITS ~ 3 PHASE

Model Reference	Type	HP	Cool	Heat*	SEER	SCoP	Description	LIST PRICE £
AM080AXVAGH/EU	2-Pipe	8	22.4kW	25.2kW	6.50	4.20	DVMS2 Standard Efficiency Heat Pump Inverter R410A	5,005.00
AM100AXVAGH/EU	2-Pipe	10	28.0kW	31.5kW	6.20	4.20	DVMS2 Standard Efficiency Heat Pump Inverter R410A	5,465.00
AM120AXVAGH/EU	2-Pipe	12	33.6kW	37.8kW	6.60	4.40	DVMS2 Standard Efficiency Heat Pump Inverter R410A	6,645.00
AM140AXVAGH/EU	2-Pipe	14	40.0kW	45.0kW	6.40	4.20	DVMS2 Standard Efficiency Heat Pump Inverter R410A	7,711.00
AM160AXVAGH/EU	2-Pipe	16	45.0kW	50.4kW	6.50	4.30	DVMS2 Standard Efficiency Heat Pump Inverter R410A	9,103.00
AM180AXVAGH/EU	2-Pipe	18	50.4kW	56.7kW	6.10	4.20	DVMS2 Standard Efficiency Heat Pump Inverter R410A	9,841.00
AM200AXVAGH/EU	2-Pipe	20	56.0kW	63.0kW	6.20	4.10	DVMS2 Standard Efficiency Heat Pump Inverter R410A	11,197.00
AM220AXVAGH/EU	2-Pipe	22	61.6kW	69.3kW	5.90	4.10	DVMS2 Standard Efficiency Heat Pump Inverter R410A	12,458.00
AM240AXVAGH/EU	2-Pipe	24	67.2kW	75.6kW	5.60	3.70	DVMS2 Standard Efficiency Heat Pump Inverter R410A	13,789.00
AM260AXVAGH/EU	2-Pipe	26	72.8kW	81.9kW	5.10	3.70	DVMS2 Standard Efficiency Heat Pump Inverter R410A	14,669.00

*Maximum Heating capacity - a rated heating capacity is detailed in relevant catalogue and Technical Data Book.

DVM S INDOOR UNITS

Model Reference	Cool	Heat	Description
-----------------	------	------	-------------

LIST PRICE £

Circular 360 Cassette



AM045KN4DEH/EU	4.5kW	5.0kW	360 Cassette (947mm diameter)	863.00
AM056KN4DEH/EU	5.6kW	6.3kW	360 Cassette (947mm diameter)	915.00
AM071KN4DEH/EU	7.1kW	8.0kW	360 Cassette (947mm diameter)	993.00
AM090KN4DEH/EU	9.0kW	10.0kW	360 Cassette (947mm diameter)	1,136.00
AM112KN4DEH/EU	11.2kW	12.5kW	360 Cassette (947mm diameter)	1,304.00
AM128KN4DEH/EU	12.8kW	13.8kW	360 Cassette (947mm diameter)	1,467.00
AM140KN4DEH/EU	14.0kW	16.0kW	360 Cassette (947mm diameter)	1,570.00
PC4NUDMAN			360 Cassette Panel Square - WHITE	144.00
PC4NUNMAN			360 Cassette Panel Round - WHITE	144.00
PC4NBDMAN			360 Cassette Panel Square - BLACK	144.00
PC4NBNMAN			360 Cassette Panel Round - BLACK	144.00
PC6EUCMAN			360 Cassette Fascia Panel Square - PURE Filter	457.00
PC6EUXMAN			360 Cassette Fascia Panel Square - AutoLIFT	430.00

4-way high efficiency Cassette WindFree™

LIST PRICE £

High Efficiency 4way Cassette - WindFree™

NEW model



AM028AN4PKH/EU	2.8kW	3.2kW	High Efficiency WindFree 4-Way Cassette (840mm x 840mm)	698.00
AM036AN4PKH/EU	3.6kW	4.0kW	High Efficiency WindFree 4-Way Cassette (840mm x 840mm)	735.00
AM045AN4PKH/EU	4.5kW	5.0kW	High Efficiency WindFree 4-Way Cassette (840mm x 840mm)	775.00
AM056AN4PKH/EU	5.6kW	6.3kW	High Efficiency WindFree 4-Way Cassette (840mm x 840mm)	818.00
AM071AN4PKH/EU	7.1kW	8.0kW	High Efficiency WindFree 4-Way Cassette (840mm x 840mm)	853.00
AM090AN4PKH/EU	9.0kW	10.0kW	High Efficiency WindFree 4-Way Cassette (840mm x 840mm)	972.00
AM112AN4PKH/EU	11.2kW	12.5kW	High Efficiency WindFree 4-Way Cassette (840mm x 840mm)	1,061.00
AM128AN4PKH/EU	12.8kW	13.8kW	High Efficiency WindFree 4-Way Cassette (840mm x 840mm)	1,260.00
AM140AN4PKH/EU	14.0kW	16.0kW	High Efficiency WindFree 4-Way Cassette (840mm x 840mm)	1,346.00
PC4NUFMAN			WindFree 4-Way Cassette Fascia Panel	144.00
PC4NUCEAN			WindFree 4-Way Cassette Fascia Panel - PURE Filter	515.00
PC4NUXMAN			WindFree 4-Way Cassette Fascia Panel - AutoLIFT	358.00

4-way Cassette WindFree™

LIST PRICE £

4way Cassette - WindFree™



AM045NN4DEH/EU	4.5kW	5.0kW	WindFree 4-Way Cassette (840mm x 840mm)	766.00
AM056NN4DEH/EU	5.6kW	6.3kW	WindFree 4-Way Cassette (840mm x 840mm)	810.00
AM071NN4DEH/EU	7.1kW	8.0kW	WindFree 4-Way Cassette (840mm x 840mm)	845.00
AM090NN4DEH/EU	9.0kW	10.0kW	WindFree 4-Way Cassette (840mm x 840mm)	963.00
AM112NN4DEH/EU	11.2kW	12.5kW	WindFree 4-Way Cassette (840mm x 840mm)	1,051.00
AM128NN4DEH/EU	12.8kW	13.8kW	WindFree 4-Way Cassette (840mm x 840mm)	1,247.00
AM140NN4DEH/EU	14.0kW	16.0kW	WindFree 4-Way Cassette (840mm x 840mm)	1,334.00
PC4NUFMAN			WindFree 4-Way Cassette Fascia Panel	144.00
PC4NUCEAN			WindFree 4-Way Cassette Fascia Panel - PURE Filter	515.00
PC4NUXMAN			WindFree 4-Way Cassette Fascia Panel - AutoLIFT	358.00

4-way Mini Cassette WindFree™

LIST PRICE £

4way mini Cassette - WindFree™



AM015NNNDEH/EU	1.5kW	1.7kW	WindFree Mini 4-Way Cassette (575mm x 575mm)	623.00
AM022NNNDEH/EU	2.2kW	2.5kW	WindFree Mini 4-Way Cassette (575mm x 575mm)	629.00
AM028NNNDEH/EU	2.8kW	3.2kW	WindFree Mini 4-Way Cassette (575mm x 575mm)	647.00
AM036NNNDEH/EU	3.6kW	4.0kW	WindFree Mini 4-Way Cassette (575mm x 575mm)	665.00
AM045NNNDEH/EU	4.5kW	5.0kW	WindFree Mini 4-Way Cassette (575mm x 575mm)	733.00
AM056NNNDEH/EU	5.6kW	6.3kW	WindFree Mini 4-Way Cassette (575mm x 575mm)	812.00
AM060NNNDEH/EU	6.0kW	6.8kW	WindFree Mini 4-Way Cassette (575mm x 575mm)	861.00
PC4SUFMAN			WindFree Mini 4-Way Cassette Fascia Panel - 620x620	139.00

DVM S INDOOR UNITS

Model Reference Cool Heat Description

1-way Cassette WindFree™

LIST PRICE £

1way Cassette - WindFree™



AM017NN1PEH/EU	1.7kW	1.9kW	WindFree 1-Way Cassette (740mm x 360mm) - use small panel	768.00
AM022NN1PEH/EU	2.2kW	2.5kW	WindFree 1-Way Cassette (740mm x 360mm) - use small panel	778.00
PC1MWFMAN			WindFree 1-Way Cassette Fascia Panel - Small	139.00
PC1MWCAN			WindFree 1-Way Cassette Fascia Panel - Small - PURE Filter	409.00
AM022NN1DKH/EU	2.2kW	2.5kW	WindFree Slimline 1-Way Cassette (970mm x 410mm) - use medium panel	779.00
AM028NN1DKH/EU	2.8kW	3.2kW	WindFree Slimline 1-Way Cassette (970mm x 410mm) - use medium panel	805.00
AM036NN1DKH/EU	3.6kW	4.0kW	WindFree Slimline 1-Way Cassette (970mm x 410mm) - use medium panel	856.00
PC1NWFMAN			WindFree 1-Way Cassette Fascia Panel - Medium	139.00
PC1NWCAN			WindFree 1-Way Cassette Fascia Panel - Medium - PURE Filter	430.00
AM056NN1DEH/EU	5.6kW	6.3kW	WindFree Slimline 1-Way Cassette (1200mm x 450mm) - use large panel	937.00
AM071NN1DEH/EU	7.1kW	8.0kW	WindFree Slimline 1-Way Cassette (1200mm x 450mm) - use large panel	992.00
PC1BWFMAN			WindFree 1-Way Cassette Fascia Panel - Large	139.00
PC1BWCAN			WindFree 1-Way Cassette Fascia Panel - Large - PURE Filter	487.00

Slimline Ducted

LIST PRICE £

Slim Duct

NEW model



AM017ANLDKH/EU	1.7kW	1.9kW	Slimline Ducted Unit	557.00
AM022ANLDKH/EU	2.2kW	2.5kW	Slimline Ducted Unit	583.00
AM028ANLDKH/EU	2.8kW	3.2kW	Slimline Ducted Unit	613.00
AM036ANLDKH/EU	3.6kW	4.0kW	Slimline Ducted Unit	629.00
AM045ANLDKH/EU	4.5kW	5.0kW	Slimline Ducted Unit	673.00
AM056ANLDKH/EU	5.6kW	6.3kW	Slimline Ducted Unit	764.00
AM071ANLDKH/EU	7.1kW	8.0kW	Slimline Ducted Unit	808.00
AM090ANLDKH/EU	9.0kW	10.0kW	Slimline Ducted Unit	1,168.00
AM112ANLDKH/EU	11.2kW	12.5kW	Slimline Ducted Unit	1,281.00
AM128ANLDKH/EU	12.8kW	13.8kW	Slimline Ducted Unit	1,328.00
AM140ANLDKH/EU	14.0kW	16.0kW	Slimline Ducted Unit	1,386.00

Slimline Ducted with condensate pump

LIST PRICE £

AM017KNLDEH/EU	1.7kW	1.9kW	Slimline Ducted Unit with built-in condensate pump	619.00
AM022KNLDEH/EU	2.2kW	2.5kW	Slimline Ducted Unit with built-in condensate pump	647.00
AM028KNLDEH/EU	2.8kW	3.2kW	Slimline Ducted Unit with built-in condensate pump	673.00
AM036KNLDEH/EU	3.6kW	4.0kW	Slimline Ducted Unit with built-in condensate pump	691.00
AM045MNLDEH/EU	4.5kW	5.0kW	Slimline Ducted Unit with built-in condensate pump	735.00
AM056MNLDEH/EU	5.6kW	6.3kW	Slimline Ducted Unit with built-in condensate pump	825.00
AM071MNLDEH/EU	7.1kW	8.0kW	Slimline Ducted Unit with built-in condensate pump	868.00
AM090MNLDEH/EU	9.0kW	10.0kW	Slimline Ducted Unit with built-in condensate pump	1,229.00
AM112MNLDEH/EU	11.2kW	12.5kW	Slimline Ducted Unit with built-in condensate pump	1,342.00
AM128MNLDEH/EU	12.8kW	13.8kW	Slimline Ducted Unit with built-in condensate pump	1,387.00
AM140MNLDEH/EU	14.0kW	16.0kW	Slimline Ducted Unit with built-in condensate pump	1,450.00

Slimline Ducted with condensate pump

LIST PRICE £

AM045KNLDEH/EU	4.5kW	5.0kW	Slimline Ducted Unit with built-in condensate pump	735.00
AM056KNLDEH/EU	5.6kW	6.3kW	Slimline Ducted Unit with built-in condensate pump	825.00
AM071KNLDEH/EU	7.1kW	8.0kW	Slimline Ducted Unit with built-in condensate pump	868.00
AM090KNLDEH/EU	9.0kW	10.0kW	Slimline Ducted Unit with built-in condensate pump	1,229.00
AM112KNLDEH/EU	11.2kW	12.5kW	Slimline Ducted Unit with built-in condensate pump	1,342.00
AM128KNLDEH/EU	12.8kW	13.8kW	Slimline Ducted Unit with built-in condensate pump	1,387.00
AM140KNLDEH/EU	14.0kW	16.0kW	Slimline Ducted Unit with built-in condensate pump	1,450.00

DVM S INDOOR UNITS

Model Reference Cool Heat Description

LIST PRICE £

Mid Static Duct S

NEW model



AM022ANMPKH/EU	2.2kW	2.5kW	Duct S MSP Ducted Unit - Built-in Condensate Pump	719.00
AM028ANMPKH/EU	2.8kW	3.2kW	Duct S MSP Ducted Unit - Built-in Condensate Pump	741.00
AM036ANMPKH/EU	3.6kW	4.0kW	Duct S MSP Ducted Unit - Built-in Condensate Pump	764.00
AM045ANMPKH/EU	4.5kW	5.0kW	Duct S MSP Ducted Unit - Built-in Condensate Pump	793.00
AM056ANMPKH/EU	5.6kW	6.3kW	Duct S MSP Ducted Unit - Built-in Condensate Pump	838.00
AM071ANMPKH/EU	7.1kW	8.0kW	Duct S MSP Ducted Unit - Built-in Condensate Pump	866.00
AM090ANMPKH/EU	9.0kW	10.0kW	Duct S MSP Ducted Unit - Built-in Condensate Pump	1,163.00
AM112ANMPKH/EU	11.2kW	12.5kW	Duct S MSP Ducted Unit - Built-in Condensate Pump	1,263.00
AM128ANMPKH/EU	12.8kW	13.8kW	Duct S MSP Ducted Unit - Built-in Condensate Pump	1,298.00
AM140ANMPKH/EU	14.0kW	16.0kW	Duct S MSP Ducted Unit - Built-in Condensate Pump	1,381.00

MSP Ducted

LIST PRICE £

Mid Static Duct



AM022FNMDEH/EU	2.2kW	2.5kW	MSP Ducted Unit	683.00
AM028FNMDEH/EU	2.8kW	3.2kW	MSP Ducted Unit	701.00
AM036FNMDEH/EU	3.6kW	4.0kW	MSP Ducted Unit	717.00
AM045FNMDEH/EU	4.5kW	5.0kW	MSP Ducted Unit	745.00
AM056FNMDEH/EU	5.6kW	6.3kW	MSP Ducted Unit	792.00
AM071FNMDEH/EU	7.1kW	8.0kW	MSP Ducted Unit	817.00
AM090FNMDEH/EU	9.0kW	10.0kW	MSP Ducted Unit	1,076.00
AM112FNMDEH/EU	11.2kW	12.5kW	MSP Ducted Unit	1,181.00

whilst stocks last

MSP Ducted with condensate pump

LIST PRICE £

AM022KNMDEH/EU	2.2kW	2.5kW	MSP Ducted Unit with built-in condensate pump	745.00
AM028KNMDEH/EU	2.8kW	3.2kW	MSP Ducted Unit with built-in condensate pump	763.00
AM036KNMDEH/EU	3.6kW	4.0kW	MSP Ducted Unit with built-in condensate pump	782.00
AM045KNMDEH/EU	4.5kW	5.0kW	MSP Ducted Unit with built-in condensate pump	809.00
AM056KNMDEH/EU	5.6kW	6.3kW	MSP Ducted Unit with built-in condensate pump	852.00
AM071KNMDEH/EU	7.1kW	8.0kW	MSP Ducted Unit with built-in condensate pump	880.00
AM090KNMDEH/EU	9.0kW	10.0kW	MSP Ducted Unit with built-in condensate pump	1,137.00
AM112KNMDEH/EU	11.2kW	12.5kW	MSP Ducted Unit with built-in condensate pump	1,241.00

whilst stocks last

HSP Ducted with condensate pump

LIST PRICE £

High Static Duct

NEW model



AM056ANHPKH/EU	5.6kW	6.3kW	HSP Ducted Unit - Built-in Condensate Pump	1,144.00
AM071ANHPKH/EU	7.1kW	8.0kW	HSP Ducted Unit - Built-in Condensate Pump	1,272.00
AM090ANHPKH/EU	9.0kW	10.0kW	HSP Ducted Unit - Built-in Condensate Pump	1,413.00
AM112ANHPKH/EU	11.2kW	12.5kW	HSP Ducted Unit - Built-in Condensate Pump	1,504.00
AM128ANHPKH/EU	12.8kW	13.8kW	HSP Ducted Unit - Built-in Condensate Pump	1,540.00
AM140ANHPKH/EU	14.0kW	16.0kW	HSP Ducted Unit - Built-in Condensate Pump	1,581.00

HSP Ducted - Large

LIST PRICE £

High Static Duct - Large



AM180JNHFKH/EU	18.0kW	20.0kW	Large HSP Ducted Unit	2,072.00
AM220FNHDEH/EU	22.0kW	25.0kW	Large HSP Ducted Unit	2,435.00
AM280FNHDEH/EU	28.0kW	31.5kW	Large HSP Ducted Unit	2,520.00

Outdoor Air Processing(OAP) Unit

LIST PRICE £

OAP Unit



AM140MNEPEH/EU	14.0kW	16.0kW	OAP (Outdoor Air Processing Ducted Unit)	1,673.00
AM220MNEPEH/EU	22.0kW	25.0kW	OAP (Outdoor Air Processing Ducted Unit)	2,770.00
AM280MNEPEH/EU	28.0kW	31.5kW	OAP (Outdoor Air Processing Ducted Unit)	3,023.00

DVM S INDOOR UNITS

Model Reference Cool Heat Description
Ceiling/Floor (No EEV) - please order EEV accessory

LIST PRICE £

Ceiling/Floor



AM056FNCDEH/EU	5.6kW	6.3kW	Under Ceiling / Floor Standing Unit	799.00
AM071FNCDEH/EU	7.1kW	8.0kW	Under Ceiling / Floor Standing Unit	888.00
MEV-E32SA			EEV Kit (1 Indoor) > 4kW	99.00

Ceiling Suspended

LIST PRICE £

Ceiling Suspended



AM112JNC DKH/EU	11.2kW	12.5kW	Under Ceiling Unit	1,303.00
AM140JNC DKH/EU	14.0kW	16.0kW	Under Ceiling Unit	1,456.00

Console - Floor - Spi filter & infra-red remote control as standard

LIST PRICE £

Floor



AM022KNJDEH/EU	2.2kW	2.5kW	Console Floor Standing Unit	708.00
AM028FNJDEH/EU	2.8kW	3.2kW	Console Floor Standing Unit	757.00
AM036FNJDEH/EU	3.6kW	4.0kW	Console Floor Standing Unit	799.00
AM045KNJDEH/EU	4.5kW	5.0kW	Console Floor Standing Unit	840.00
AM056FNJDEH/EU	5.6kW	6.3kW	Console Floor Standing Unit	844.00

Hi-Static Floor Standing Chassis (un-cased)

LIST PRICE £

Floor uncased



AM036MNFDEH/EU	3.6kW	4.0kW	High Static 60Pa Floor Standing Chassis (un-cased) Unit	703.00
AM056MNFDEH/EU	5.6kW	6.3kW	High Static 60Pa Floor Standing Chassis (un-cased) Unit	783.00
AM071MNFDEH/EU	7.1kW	8.0kW	High Static 60Pa Floor Standing Chassis (un-cased) Unit	825.00

PAC Cabinet Floor Standing - built in controls (wired remote optional)

LIST PRICE £

PAC Cabinet Floor



AM140RNPDKH/EU	14kW	16kW	PAC Cabinet Floor Unit	1,466.00
AM280RNPDKH/EU	28kW	31.5kW	PAC Cabinet Floor Unit	2,266.00

DVM S EHS

Digital Variable Multi
80°C Hydro unit



EHS Hydro Box Indoor HT - 80°C

LIST PRICE £

AM160TNBFEB/EU	~	16.0kW	EHS A2W DVM S HT Hydro Unit R134a/R410A	3,475.00
AM250TNBFEB/EU	~	25.0kW	EHS A2W DVM S HT Hydro Unit R134a/R410A	4,115.00
MWR-WW10N			DVM S EHS HE/HT LCD Colour Hard Wired Remote Controller	90.00

~ 3-phase available on request at additional cost - AM***TNBFGB/EU

50°C Hydro unit



EHS Hydro Box Indoor HE - 50°C

LIST PRICE £

AM160FNBDEH/EU	14.0kW	16.0kW	EHS A2W DVM S HE Hydro Unit R410A	1,261.00
AM320FNBDEH/EU	28.0kW	32.0kW	EHS A2W DVM S HE Hydro Unit R410A	1,878.00
AM500FNBDEH/EU	44.8kW	50.0kW	EHS A2W DVM S HE Hydro Unit R410A - ONLY for use with 2pipe HP DVM outdoors	2,200.00
MWR-WW10N			DVM S EHS HE/HT LCD Colour Hard Wired Remote Controller	90.00

DVM 5 INDOOR UNITS

Model Reference	Cool	Heat	Description	LIST PRICE £
-----------------	------	------	-------------	--------------

WindFree™ High Wall



Wall Mounted - WindFree (No EEV) - please order EEV accessory				LIST PRICE £
AM015TNADKH/EU	1.5kW	1.7kW	WindFree High Wall Mounted Unit (No EEV)	520.00
AM022TNADKH/EU	2.2kW	2.5kW	WindFree High Wall Mounted Unit (No EEV)	544.00
AM028TNADKH/EU	2.8kW	3.2kW	WindFree High Wall Mounted Unit (No EEV)	563.00
AM036TNADKH/EU	3.6kW	4.0kW	WindFree High Wall Mounted Unit (No EEV)	584.00
AM045TNADKH/EU	4.5kW	5.0kW	WindFree High Wall Mounted Unit (No EEV)	628.00
AM056TNADKH/EU	5.6kW	6.3kW	WindFree High Wall Mounted Unit (No EEV)	664.00
AM071TNADKH/EU	6.8kW	7.0kW	WindFree High Wall Mounted Unit (No EEV)	701.00
AM082TNADKH/EU	8.2kW	8.5kW	WindFree High Wall Mounted Unit (No EEV)	751.00
MEV-E24SA			EEV Kit (1 Indoor) <4kW	90.00
MEV-E32SA			EEV Kit (1 Indoor) > 4kW	99.00

Wall Mounted - WindFree (with EEV)				LIST PRICE £
AM015TNVDKH/EU	1.5kW	1.7kW	WindFree High Wall Mounted Unit (With EEV)	623.00
AM022TNVDKH/EU	2.2kW	2.5kW	WindFree High Wall Mounted Unit (With EEV)	644.00
AM028TNVDKH/EU	2.8kW	3.2kW	WindFree High Wall Mounted Unit (With EEV)	664.00
AM036TNVDKH/EU	3.6kW	4.0kW	WindFree High Wall Mounted Unit (With EEV)	682.00
AM045TNVDKH/EU	4.5kW	5.0kW	WindFree High Wall Mounted Unit (With EEV)	711.00
AM056TNVDKH/EU	5.6kW	6.3kW	WindFree High Wall Mounted Unit (With EEV)	741.00
AM071TNVDKH/EU	6.8kW	7.0kW	WindFree High Wall Mounted Unit (With EEV)	810.00
AM082TNVDKH/EU	8.2kW	8.5kW	WindFree High Wall Mounted Unit (With EEV)	878.00

High Wall Std



Wall Mounted - Boracay (No EEV) - please order EEV accessory				LIST PRICE £
AM015KNTDEH/EU	1.5kW	1.7kW	Boracay High Wall Mounted Unit (No EEV)	461.00
AM022KNTDEH/EU	2.2kW	2.5kW	Boracay High Wall Mounted Unit (No EEV)	479.00
AM028KNTDEH/EU	2.8kW	3.2kW	Boracay High Wall Mounted Unit (No EEV)	501.00
AM036KNTDEH/EU	3.6kW	4.0kW	Boracay High Wall Mounted Unit (No EEV)	515.00
AM045KNTDEH/EU	4.5kW	5.0kW	Boracay High Wall Mounted Unit (No EEV)	535.00
AM056KNTDEH/EU	5.6kW	6.3kW	Boracay High Wall Mounted Unit (No EEV)	558.00
AM071KNTDEH/EU	6.8kW	7.0kW	Boracay High Wall Mounted Unit (No EEV)	620.00
MEV-E24SA			EEV Kit (1 Indoor) <4kW	90.00
MEV-E32SA			EEV Kit (1 Indoor) > 4kW	99.00

Wall Mounted - Boracay (with EEV)				LIST PRICE £
AM015KNQDEH/EU	1.5kW	1.7kW	Boracay-E High Wall Mounted Unit (With EEV)	540.00
AM022KNQDEH/EU	2.2kW	2.5kW	Boracay-E High Wall Mounted Unit (With EEV)	556.00
AM028KNQDEH/EU	2.8kW	3.2kW	Boracay-E High Wall Mounted Unit (With EEV)	574.00
AM036KNQDEH/EU	3.6kW	4.0kW	Boracay-E High Wall Mounted Unit (With EEV)	590.00
AM045KNQDEH/EU	4.5kW	5.0kW	Boracay-E High Wall Mounted Unit (With EEV)	617.00
AM056KNQDEH/EU	5.6kW	6.3kW	Boracay-E High Wall Mounted Unit (With EEV)	641.00
AM071KNQDEH/EU	6.8kW	7.0kW	Boracay-E High Wall Mounted Unit (With EEV)	700.00

Large Wall



Large Wall Mounted - (with EEV)				LIST PRICE £
AM093MNNQDEH/EU	9.3kW	9.8kW	High Wall Mounted Unit (With EEV)	1,057.00



Accessories

DVM S MCU - HR 3pipe Mode Control Units

Model Reference	Type	Type	Description	LIST PRICE £
-----------------	------	------	-------------	--------------

For use with DVM S Eco HR (Mini VRF) - add 1, 2, 4 & 6 port MCU to match number of indoor unit connections

MCU-R4NEK0N	4 Port	ECO HR	MASTER 4-port HR MCU Kit <22.4kW (<5.6kW per port) - DVM S Eco HR	1,389.00
-------------	--------	--------	---	----------

For use with all HR outdoors - including the DVM S eco in addition to HR Master MCU above

MCU-S1NEK1N	1 Port	3-Pipe	1-port MCU Kit <16kW	584.00
MCU-S2NEK2N	2 Port	3-Pipe	2-port MCU Kit <32kW (<16kW per port) - Serial connection possible	870.00
MCU-S4NEK3N	4 Port	3-Pipe	4-port MCU Kit <61.6kW (<16kW per port) - Serial connection possible	1,310.00
MCU-S6NEK2N	6 Port	3-Pipe	6-port MCU Kit <61.6kW (<16kW per port) - Serial connection possible	1,603.00
MCU-S6NEK3N	6 Port	3-Pipe	6-port MCU Kit <22.4kW (<5.6kW per port) - Serial connection possible	1,700.00

DVM S PIPE JOINTS

Model Reference	Connect	Type	Description	LIST PRICE £
MXJ-YA1509M	IU	2-Pipe	Y-Joint (<15kW)	53.00
MXJ-YA2512M	IU	2-Pipe	Y-Joint to (15.1kW > 40kW)	91.00
MXJ-YA2812M	IU	2-Pipe	Y-Joint (40.1kW to 45kW)	112.00
MXJ-YA2815M	IU	2-Pipe	Y-Joint (45.1kW to 70.3kW)	112.00
MXJ-YA3419M	IU	2-Pipe	Y-Joint (70.4kW to 98.4kW)	135.00
MXJ-YA4119M	IU	2-Pipe	Y-Joint (98.5kW to 135.2kW)	160.00
MXJ-YA4422M	IU	2-Pipe	Y-Joint (>135.2kW)	288.00
MXJ-YA1500M	IU	3-Pipe	additional Y-Joint (<22.4kW) Discharge pipe*	42.00
MXJ-YA2500M	IU	3-Pipe	additional Y-Joint (22.5kW to 67.3kW) Discharge pipe*	70.00
MXJ-YA3100M	IU	3-Pipe	additional Y-Joint (67.4kW to 135.2kW) Discharge pipe*	107.00
MXJ-YA3800M	IU	3-Pipe	additional Y-Joint (>135.2kW) Discharge pipe*	112.00
*+ 2-Pipe Y-Joint above				
MXJ-YM1206R	IU	3-Pipe	6-14kW Connection from 1 MCU port (MCU-R4NEK0N only)	38.00
MXJ-YM1206M	IU	3-Pipe	6-14W Connection from 1 MCU port (MCU-S6NEK3N only)	48.00
MXJ-YM1509M	IU	3-Pipe	16-28kW Connection from 1 MCU port (2/4/6 MCU)	55.00
MXJ-HA2512M	IU	2-Pipe	4 way Header Joint (< 45.0kW)	58.00
MXJ-HA3115M	IU	2-Pipe	8 way Header Joint (< 70.3kW)	160.00
MXJ-HA3819M	IU	2-Pipe	8 way Header Joint (> 70.4kW)	166.00
MXJ-TA3419M	OU	2-Pipe	<49HP Multiple Outdoor Unit Connection Joint (<135.2kW)	137.00
MXJ-TA3819M	OU	2-Pipe	<49HP Multiple Outdoor Unit Connection Joint (<135.2kW)	114.00
MXJ-TA4122M	OU	2-Pipe	>50HP Multiple Outdoor Unit Connection Joint (>140.2kW)	188.00
MXJ-TA4422M	OU	2-Pipe	>50HP Multiple Outdoor Unit Connection Joint (>140.2kW)	188.00
MXJ-TA3100M	OU	3-Pipe	<49HP Outdoor Unit Connection Joint (<135.2kW) Discharge pipe*	81.00
MXJ-TA3800M	OU	3-Pipe	>50HP Outdoor Unit Connection Joint (>140.2kW) Discharge pipe*	92.00
*+ 2-Pipe Y-Joint above				
MXD-A12K2A	OU	PDM	Pressure Drop Modulation Kit (8HP to 12HP)	105.00
MXD-A38K2A	OU	PDM	Pressure Drop Modulation Kit (14HP to 16HP)	123.00
MXD-A58K2A	OU	PDM	Pressure Drop Modulation Kit (18HP to 26HP)	130.00

DVM S INDOOR UNIT EEV Kits for Wall & Ceiling units

LIST PRICE £

** Electronic Expansion Valve Kits for Boracay Wall AM...KNTDEH, AM...TNADKH & Ceiling AM...FNCDEH*

MEV-E24SA	EEV Kit (1 Indoor)	<4kW	90.00
MEV-E32SA	EEV Kit (1 Indoor)	>4kW	99.00
MXD-E24K132A	EEV Kit (2 Indoor)	port 1 <4kW, port 2 >4kW	237.00
MXD-E24K200A	EEV Kit (2 Indoor)	port 1 <4kW, port 2 <4kW	237.00
MXD-E32K200A	EEV Kit (2 Indoor)	port 1 >4kW, port 2 >4kW	237.00
MXD-E24K232A	EEV Kit (3 Indoor)	port 1 <4kW, port 2 <4kW, port 3 >4kW	301.00
MXD-E24K300A	EEV Kit (3 Indoor)	port 1 <4kW, port 2 <4kW, port 3 <4kW	301.00
MXD-E32K224A	EEV Kit (3 Indoor)	port 1 <4kW, port 2 >4kW, port 3 >4kW	301.00
MXD-E32K300A	EEV Kit (3 Indoor)	port 1 >4kW, port 2 >4kW, port 3 >4kW	301.00

DVM S OUTDOOR - CONDENSER FIN GUARD

LIST PRICE £

MOK-100GA	External DVMS OU Condenser Guard - Single Fan up blow (8 - 12HP)	58.00
MOK-200GA	External DVMS OU Condenser Guard - Double Fan up blow (14 - 22HP)	84.00
MOK-300GA	External Super DVMS OU Condenser Guard - Double Fan (24, 26HP)	146.00

DIAGNOSTIC TOOLS

LIST PRICE £

MIM-C02N	S Net Pro Converter (USB)	179.00
----------	---------------------------	--------

DVM S2 | WindFree™

Digital Variable Multi Compatible

Controls, Accessories & Pumps



DVM S INTERFACES & CONTROLS		LIST PRICE £
Model Reference	Description	
INDIVIDUAL CONTROLS		
MWR-WG00JN	LCD COLOUR PREMIUM Wired Controller (NASA)	90.00
MWR-SH11N	Touch Simplified Wired Remote Controller - WindFree™ (NASA)	88.00
MWR-WW10N	DVM S EHS HE/HT LCD Colour Hard Wired Remote Controller	90.00
AR-KH03E	360 Wireless Remote controller (SPLIT/DVM)	34.00
AR-EH03E	WindFree & STANDARD Wireless Remote controller (SPLIT/DVM)	34.00
MRK-A10N	DUCT S & Slim Duct Wireless Signal Receiver Kit (requires AR-EH03E)	33.00
MIM-H04EN	Wi-Fi Receiver 2.0 for NASA SPLIT/DVM IU	132.00
CENTRAL CONTROLS		LIST PRICE £
MCM-A300N	Touch Screen Controller (Centralised management of up to 128 indoor units)	609.00
MCM-A202DN	Centralised On/Off Controller (maximum of 16 Group controls (maximum of 256 indoor units)	95.00
BMS GATEWAYS & INTERFACES		LIST PRICE £
MIM-D01AN	Data Management Server (DVM/FJM/CAC/ERV) central management of up to 256 indoor units, web server	1,048.00
MIM-B16N	Pulse Input Module (PIM) - Watt Hour Meter Interface Module (connect up to 8 watt hour meters)	293.00
MIM-B17BN	BACnet DMS 2 (Data Management Server with Built in BACnet Gateway - maximum 256 indoor units)	1,930.00
MIM-B18BN	LONWorks DMS 2 (Data Management Server with Built in LONWorks Gateway - maximum 128 indoor units)	1,930.00
MIM-B19N	MODBUS interface Module 48 indoor units (1 outdoor)	132.00
MST-BL1A	b.IoT Lite PC software for DVM S systems - Optimal central control of small & medium size buildings	1,133.00
MST-P3P	SNET-3 Web server Software - connect upto 16 DMS & control upto 4096 indoor units	1,655.00
DIAGNOSTIC TOOLS		LIST PRICE £
MIM-C02N	S Net Pro Converter (USB)	179.00
INTERFACES & ACCESSORIES		LIST PRICE £
MIM-B14	External Contact Interface Module (remote on/off, unit operation/error output)	20.00
MIM-B14A	Leak Detection Contact Interface	26.00
MRW-TA	Remote Temperature Sensor	22.00
MCM-C200	Mode Selection Switch - operation mode selection (cooling, heating, auto)	52.00
MCM-C210N	Multi Tenant Function Controller	67.00
MCR-SMC	Motion detect sensor for 4-way Cassette (WindFree) - for 950x950 panel	66.00
MCR-SMD	Motion detect sensor for 4-way Mini Cassette (WindFree) - for 620x620 panel	66.00
MCR-SME	Motion detect sensor for 360 Cassette - for SQUARE panel	66.00
MSD-CAN1	S-Plasma Ion Kit for 4way & 360 Cassette	65.00
MSD-EAN1	S-Plasma Ion Healthy Air Provider for Ducted (Duct S)	65.00
MIM-N01	NASA to RS485 - forwards and backward communications protocol converter	166.00
MOK-200DA	L shape Drain for 1way cassette - Travelodge Spec	12.00
DVM S CASSETTE INDOOR UNIT PANELS		LIST PRICE £
PC4NUDMAN	360 Cassette Panel Square	144.00
PC4NUNMAN	360 Cassette Panel Round	144.00
PC4NBDMAN	360 Cassette Panel Square - BLACK	144.00
PC4NBNMAN	360 Cassette Panel Round - BLACK	144.00
PC6EUCMAN	360 Cassette Fascia Panel Square - PURE Filter	457.00
PC6EUXMAN	360 Cassette Fascia Panel Square - AutoLIFT	430.00
PC4NUFMAN	WindFree 4-Way Cassette Fascia Panel	144.00
PC4SUFMAN	WindFree Mini 4-Way Cassette Fascia Panel - 620x620	139.00
PC4NUCEAN	WindFree 4-Way Cassette Fascia Panel - PURE Filter	515.00
PC4NUXMAN	WindFree 4-Way Cassette Fascia Panel - AutoLIFT	358.00
PC1MWFMAN	WindFree 1-Way Cassette Fascia Panel - small	139.00
PC1NWFMAN	WindFree 1-Way Cassette Fascia Panel - medium	139.00
PC1BWFMAN	WindFree 1-Way Cassette Fascia Panel - large	139.00
PC1MWCMAN	WindFree 1-Way Cassette Fascia Panel - Small - PURE Filter	409.00
PC1NWCMAN	WindFree 1-Way Cassette Fascia Panel - Medium - PURE Filter	430.00
PC1BWCMAN	WindFree 1-Way Cassette Fascia Panel - Large - PURE Filter	487.00
DVM S INDOOR - DRAIN PUMPS		LIST PRICE £
MDP-G075SP	Drain Pump for DUCT S Ducted Unit (External Assembly)	72.00
MDP-G075SQ	Drain Pump for DUCT S Ducted Unit (Internal Assembly)	72.00
MDP-E075SEE3D	Drain Pump for Slimline Ducted Unit (FNL model) & 2.2, 2.8 & 3.6kW ducted (FNM model)	77.00
MDP-M075SGU3D	Drain Pump for MSP Ducted Unit 4.5kW to 7.1kW - (FNM Model)	72.00
MDP-M075SGU1D	Drain Pump for MSP Ducted Unit 9.0kW to 11.2kW - (FNM Model)	72.00
MDP-M075SGU2D	Drain Pump for OAP model - AM140MNEPEH/EU	72.00
MDP-N047SNC1D	Drain Pump for HSP Ducted Unit (22kW & 28kW)	81.00

DVM S

Digital Variable Multi

CHILLER

DVM - VRF Hybrid Chiller



DVM - VRF CHILLER UNITS HP ~ 3 PHASE

Model Reference	Type	HP	Cool	Heat	usRTon	ESEER	Description	LIST PRICE £
AG042KSVANH/EU	HP	15	42.0kW	42.0kW	12	5.7	DVM S Chiller - without pump	13,927.00
AG056KSVANH/EU	HP	20	56.0kW	56.0kW	16	5.4	DVM S Chiller - without pump	14,534.00
AG070KSVANH/EU	HP	25	65.0kW	69.5kW	18.5	5	DVM S Chiller - without pump	15,560.00

* MCM-A00N REQUIRED TO COMMISSION SYSTEM



360 Cassette	Type	Cool	Heat	Description	LIST PRICE £
--------------	------	------	------	-------------	--------------

Circular 360 Cassette - Chilled Water FCU

AG060MN4PKH/EU	Chiller FCU	6.00kW	7.30kW	360 Cassette FCU (947mm diameter)	963.00
AG072MN4PKH/EU	Chiller FCU	7.20kW	8.50kW	360 Cassette FCU (947mm diameter)	1,066.00
AG090MN4PKH/EU	Chiller FCU	9.00kW	10.0kW	360 Cassette FCU (947mm diameter)	1,227.00
AG105MN4PKH/EU	Chiller FCU	10.0kW	10.7kW	360 Cassette FCU (947mm diameter)	1,406.00
PC4NUDMAN				360 Cassette Panel Square WHITE	144.00
PC4NUNMAN				360 Cassette Panel Round WHITE	144.00
PC4NBDMAN				360 Cassette Panel Square - BLACK	144.00
PC4NBNMAN				360 Cassette Panel Round - BLACK	144.00

FCU's can be used on 3rd Party Chilled Water Systems

4way Cassette - WindFree™ - Chilled Water FCU

NEW model



4-way Cassette	Type	Cool	Heat	Description	LIST PRICE £
AG060AN4DKH/EU	Chiller FCU	6.00kW	7.30kW	WindFree 4-Way Cassette FCU (840mm x 840mm)	798.00
AG072AN4DKH/EU	Chiller FCU	7.20kW	8.50kW	WindFree 4-Way Cassette FCU (840mm x 840mm)	825.00
AG090AN4DKH/EU	Chiller FCU	9.00kW	10.0kW	WindFree 4-Way Cassette FCU (840mm x 840mm)	1,022.00
AG105AN4DKH/EU	Chiller FCU	10.0kW	10.7kW	WindFree 4-Way Cassette FCU (840mm x 840mm)	1,108.00
PC4NUFMAN				WindFree 4-Way Cassette Fascia Panel	144.00
PC4NUCEAN				WindFree 4-Way Cassette Fascia Panel - PURE Filter	515.00
PC4NUXMAN				WindFree 4-Way Cassette Fascia Panel - AutoLIFT	358.00

FCU's can be used on 3rd Party Chilled Water Systems

1way Cassette - Chilled Water FCU



1-way Cassette	Type	Cool	Heat	Description	LIST PRICE £
AG026MN1DEH/EU	Chiller FCU	2.60kW	2.90kW	1way Cassette FCU	776.00
AG032MN1DEH/EU	Chiller FCU	3.00kW	3.35kW	1way Cassette FCU	803.00
PC1NUSMAN				Slimline 1-Way Cassette Fascia Panel Stripe	139.00
AG042MN1DEH/EU	Chiller FCU	4.15kW	5.00kW	1way Cassette FCU	1,045.00
PC1BWSMAN				Slimline 1-Way Cassette WAVE STYLE Fascia Panel - 4.5kW	139.00

1way Cassette - WindFree™ - Chilled Water FCU

NEW model



1-way Cassette	Type	Cool	Heat	Description	LIST PRICE £
AG026TN1DKH/EU	Chiller FCU	2.60kW	2.90kW	1way Wind-free Cassette FCU	797.00
AG032TN1DKH/EU	Chiller FCU	3.00kW	3.35kW	1way Wind-free Cassette FCU	827.00
PC1NWFMBN				Medium 1-Way Wind-free Chiller Cassette Fascia Panel	139.00
AG042TN1DKH/EU	Chiller FCU	4.15kW	5.00kW	1way Wind-free Cassette FCU	1,076.00
PC1BWFMBN				Large 1-Way Wind-free Chiller Cassette Fascia Panel	139.00

Cooling: Indoor temperature 27°C DB, 19°C WB / Water In/Out temperature 7°C, 12°C Heating: Indoor temperature 20°C DB, 15°C WB / Water In/Out temperature 45°C, 40°C

FCU's can be used on 3rd Party Chilled Water Systems

CHILLER

3rd Party FCUs

Built-in Samsung Control Board



Concealed FCU - vertical or Horizontal installation

Concealed FCU	Type	Cool	Heat	Description	LIST PRICE £
ACL-18DF	Chiller FCU	1.7kW	1.8kW	Concealed FCU incl. FCU kit and 3-way valve kit	711.00
ACL-25DF	Chiller FCU	2.4kW	2.3kW	Concealed FCU incl. FCU kit and 3-way valve kit	740.00
ACL-35DF	Chiller FCU	3.2kW	3.2kW	Concealed FCU incl. FCU kit and 3-way valve kit	796.00
ACL-55DF	Chiller FCU	5.7kW	5.7kW	Concealed FCU incl. FCU kit and 3-way valve kit	974.00
ACL-65DF	Chiller FCU	6.0kW	6.5kW	Concealed FCU incl. FCU kit and 3-way valve kit	1,053.00

* above units fitted with Samsung Chiller interface as standard (MIM-F00N)



Cased FCU - vertical or Horizontal installation

Cased FCU	Type	Cool	Heat	Description	LIST PRICE £
ACL-18DG	Chiller FCU	1.7kW	1.8kW	Cased FCU incl. FCU kit and 3-way valve kit	799.00
ACL-25DG	Chiller FCU	2.4kW	2.3kW	Cased FCU incl. FCU kit and 3-way valve kit	846.00
ACL-35DG	Chiller FCU	3.2kW	3.2kW	Cased FCU incl. FCU kit and 3-way valve kit	912.00
ACL-55DG	Chiller FCU	5.7kW	5.7kW	Cased FCU incl. FCU kit and 3-way valve kit	1,160.00
ACL-65DG	Chiller FCU	6.0kW	6.5kW	Cased FCU incl. FCU kit and 3-way valve kit	1,249.00

* above units fitted with Samsung Chiller interface as standard (MIM-F00N)

GALLETTI FCU ACCESSORIES & CONTROLS				Description	LIST PRICE £
ACL-A018HC	Heating coil 4-pipe			4-pipe installation heating coil for ACL-18, supplied loose	63.00
ACL-A025HC	Heating coil 4-pipe			4-pipe installation heating coil for ACL-25, supplied loose	79.00
ACL-A035HC	Heating coil 4-pipe			4-pipe installation heating coil for ACL-35, supplied loose	84.00
ACL-A055HC	Heating coil 4-pipe			4-pipe installation heating coil for ACL-55-65, supplied loose	135.00
ACL-A018V3	3-way valve for 4-pipe			3-way valve kit for heating coil for AC-18-35, supplied loose	116.00
ACL-A055V3	3-way valve for 4-pipe			3-way valve kit for heating coil for AC-55-65, supplied loose	116.00
ACL-ADV	Drain Pan Vertical			Auxiliary drain pan for vertical installation, supplied loose	9.00
ACL-ADH	Drain Pan Horizontal			Auxiliary drain pan for horizontal installation, supplied loose	12.00
ACL-ADP	Drain Pump			Drain pump, supplied loose	167.00

DVM S CHILLER & FCU ACCESSORIES & CONTROLS			
Model Reference	Description		LIST PRICE £
MCM-A00N	DVM Chiller Module Controller (Set-up, commissioning and control)		115.00
MWR-WG00JN	LCD COLOUR PREMIUM Wired Controller (NASA) - Fan coil controller		90.00
MWR-SH11N	Simplified Wired Remote Controller (NASA)		88.00
MCM-A300N	Touch Screen Controller NASA (Centralised management of up to 128 indoor units)		609.00
MSD-CAN1	S-Plasma Ion Kit for 4way & 360 Cassette		65.00
MIM-F00N	DVM Chiller FCU kit		220.00
MIM-F10N	DVM Chiller Hub PBA		45.00
ACL-A26V3	3-way valve for Samsung FCU	3-way valve kit for SAMSUNG FCUs AG26-42, supplied loose	135.00
ACL-A60V3	3-way valve for Samsung FCU	3-way valve kit for SAMSUNG FCUs AG60-105, supplied loose	145.00
MIM-D01AN	Data Management Server (DVM/FJM/SPLIT/ERV) central management of up to 256 indoor units, web server		1,048.00
MIM-B16N	Pulse Input Module (PIM) - Watt Hour Meter Interface Module (connect up to 8 watt hour meters)		293.00
MIM-B17BN	BACnet DMS 2 (Data Management Server with Built in BACnet Gateway - maximum 256 indoor units)		1,930.00
MIM-B18BN	LONWorks DMS 2 (Data Management Server with Built in LONWorks Gateway - maximum 128 indoor units)		1,930.00
MIM-B19N	MODBUS interface Module 48 indoor units (1 outdoor)		132.00

A Resource Bank For All Things Samsung

As one of Samsung's registered Climate Solutions partners, you will have access to our Partner Portal and its many benefits. Whether you are looking for marketing materials or technical product documentation, requesting technical support or subscribing for training, the Samsung Climate Solutions Partner Portal offers you everything you need to consistently deliver the best results.

Access Technical Resources

The Technical Resources section allows you to find all relevant information to understand the product's functionality and to prepare and design projects. Ranging from technical data books, BIM files and certificates to exploded views, drawings and different kinds of manuals, a library full of technical information is at your fingertips.

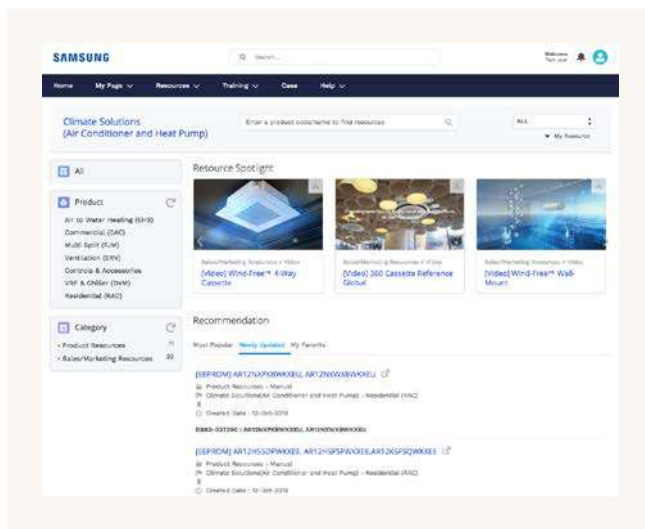
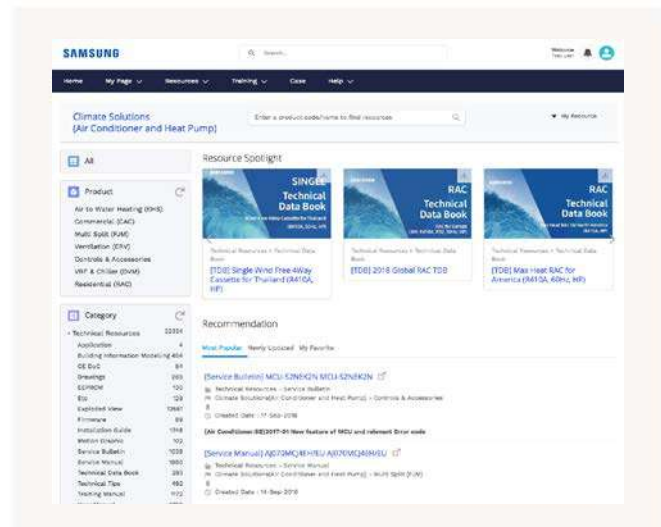

Obtain Marketing Resources

Potential buyers like to know you are on the cutting edge of Samsung's latest innovations. To allow you to align with Samsung's marketing initiatives, the Partner Portal provides you with useful downloadable assets such as images and videos, designed to make your marketing activities easy and effective.

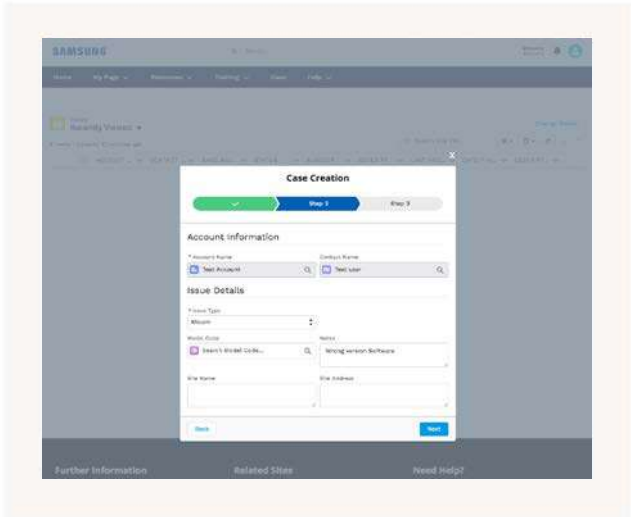

Request Technical Support

Through the Samsung Partner Portal you can easily request technical support by raising your case using our built-in ticketing system. You can rest assured that our well-trained technical experts will work to solve your issue as soon as possible.

Register for Training

If you are dedicated to becoming a Samsung climate solutions expert, you can access Samsung's educational portal for training sessions by experienced trainers. The portal allows you to search for online courses and materials, test your climate solutions knowledge, and more. The Samsung Business Academy is here to help you succeed.*

* The registration process and availability of training courses may differ per country. Please contact your direct Samsung contact person for more information.

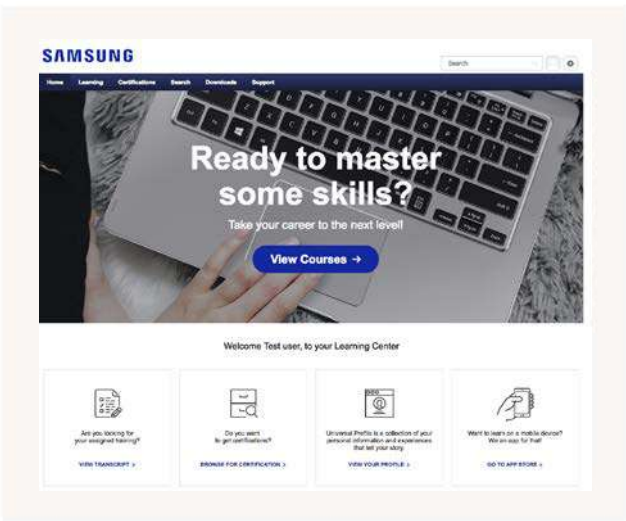

How To Access



Register

To register for the Samsung Climate Solutions Partner Portal, open your web browser* and go to partnerhub.samsung.com/climate to complete the registration form.



Access

Your information will be verified and your account will be activated. You will receive your personal login credentials.



Manage account

Keep your account details up to date and invite your colleagues to join.



Search and download

Access a full library of resources, request technical support, or sign up for a Climate Solutions Academy training session.

* The recommended web browser for using the Samsung Climate Solutions Partner Portal is Google Chrome.

Monobloc Type



R32



ASHP Monobloc R32					LIST PRICE £
Model Reference	Heat	phase	Description		
AE050RXYDEG/EU	5kW	1ph	MONO A2W Inverter Heat Pump R32		2,221.00
AE080RXYDEG/EU	8kW	1ph	MONO A2W Inverter Heat Pump R32		2,620.00
AE120RXYDEG/EU	12kW	1ph	MONO A2W Inverter Heat Pump R32		3,817.00
AE160RXYDEG/EU	16kW	1ph	MONO A2W Inverter Heat Pump R32		4,238.00
AE080RXYDGG/EU	8kW	3ph	MONO A2W Inverter Heat Pump R32		2,831.00
AE120RXYDGG/EU	12kW	3ph	MONO A2W Inverter Heat Pump R32		4,086.00
AE160RXYDGG/EU	16kW	3ph	MONO A2W Inverter Heat Pump R32		4,538.00
MIM-E03CN		1ph	Mono Control Kit - R32 EHS (MWR-WW10N included)		521.00



ASHP Monobloc ClimateHub Tank *					LIST PRICE £
AE200RNWMEG/EU	Mono	1ph	200L	Mono Tank (MWR-WW10N NOT Included)*	3,785.00
AE260RNWMEG/EU	Mono	1ph	260L	Mono Tank (MWR-WW10N NOT Included)*	3,861.00
AE260RNWMGG/EU	Mono	3ph	260L	Mono Tank (MWR-WW10N NOT Included)*	4,056.00

* G3 Kit (purchased from others) required for each ClimateHub installation.

ASHP MONO CONTROLS & ACCESSORIES					LIST PRICE £
MHC-015EE				SPLIT & MONO Optional Base Plate Heater (Post Defrost Water Removal)	55.00
MWR-WW10N				NEW LCD Colour Premium Wired Remote Control for EHS	90.00
MIM-H04EN				NEW Wi-Fi Receiver 2.0 for NASA EHS	132.00
MHC-400FE	4kW	1ph		Optional Tank Backup Heater for Climate Hub	410.00
MHC-600FE	6kW	1ph		Optional Tank Backup Heater for Climate Hub	464.00
MRW-TA				Remote Temperature Sensor	22.00



ASHP Split R32					LIST PRICE £
Model Reference	Heat	phase	Description		
AE040RXEDEG/EU	4kW	1ph		SPLIT A2W Inverter Heat Pump R32	1,023.00
AE060RXEDEG/EU	6kW	1ph		SPLIT A2W Inverter Heat Pump R32	1,263.00
AE090RXEDEG/EU	9kW	1ph		SPLIT A2W Inverter Heat Pump R32	1,611.00
AE090RNYDEG/EU	4-9kW	1ph	HYDRO	SPLIT A2W Hydro unit R32 (inc. Wired Controller)	1,937.00
AE090RXEDGG/EU	9kW	3ph		SPLIT A2W Inverter Heat Pump R32	1,735.00
AE090RNYDGG/EU	4-9kW	3ph	HYDRO	SPLIT A2W Hydro unit R32 (inc. Wired Controller)	2,302.00



ASHP Split ClimateHub with Integrated Hydro Tank * - R32					LIST PRICE £
AE200RNWSEG/EU	Split	1ph	200L	Split Integrated Hydro Tank (MWR-WW10N NOT Included) *	3,893.00
AE260RNWSEG/EU	Split	1ph	260L	Split Integrated Hydro Tank (MWR-WW10N NOT Included) *	3,970.00
AE260RNWSGG/EU	Split	3ph	260L	Split Integrated Hydro Tank (MWR-WW10N NOT Included) *	4,164.00

* G3 Kit (purchased from others) required for each ClimateHub installation.

Split Type - large

R410A



ASHP Split R410A					LIST PRICE £
Model Reference	Heat	phase	Description		
AE120AXEDEH/EU	12kW	1ph		SPLIT A2W Inverter Heat Pump R410A	2,133.00
AE160AXEDEH/EU	16kW	1ph		SPLIT A2W Inverter Heat Pump R410A	2,573.00
AE160ANYDEH/EU	12-16kW	1ph	HYDRO	SPLIT A2W Hydro unit R410A (inc. Wired Controller)	1,996.00
AE120AXEDGH/EU	12kW	3ph		SPLIT A2W Inverter Heat Pump R410A	2,246.00
AE160AXEDGH/EU	16kW	3ph		SPLIT A2W Inverter Heat Pump R410A	2,685.00
AE160ANYDGH/EU	12-16kW	3ph	HYDRO	SPLIT A2W Hydro unit R410A (inc. Wired Controller)	2,345.00

NOTE: R410A cannot be connected to R32 Climate Hub

ASHP SPLIT CONTROLS & ACCESSORIES				LIST PRICE £
MHC-015EE			SPLIT & MONO Optional Base Plate Heater (Post Defrost Water Removal)	55.00
MWR-WW10N			NEW LCD Colour Premium Wired Remote Control for EHS	90.00
MIM-H04EN			NEW Wi-Fi Receiver 2.0 for NASA EHS	132.00
MHC-400FE	4kW	1ph	Optional Tank Backup Heater for Climate Hub	410.00
MHC-600FE	6kW	1ph	Optional Tank Backup Heater for Climate Hub	464.00
MRW-TA			Remote Temperature Sensor	22.00



TDM+ R410A - Time Division Multi - ASHP & A/C combined

EHS TDM+ R410A					
Model Reference	Heat	phase	Description		LIST PRICE £
AE044MXTPEH/EU	4.4kW	1ph		TDM PLUS A2A & A2W Inverter Heat Pump R410A	1,240.00
AE066MXTPEH/EU	6.6kW	1ph		TDM PLUS A2A & A2W Inverter Heat Pump R410A	1,519.00
AE090MXTPEH/EU	9kW	1ph		TDM PLUS A2A & A2W Inverter Heat Pump R410A	1,849.00
AE120MXTPEH/EU	12kW	1ph		TDM PLUS A2A & A2W Inverter Heat Pump R410A	2,628.00
AE160MXTPEH/EU	16kW	1ph		TDM PLUS A2A & A2W Inverter Heat Pump R410A	3,286.00
AE090MNYDEH/EU	4-9kW	1ph	HYDRO	TDM PLUS A2W Hydro unit R410A (Inc. Wired controller)	2,105.00
AE160MNYDEH/EU	12-16kW	1ph	HYDRO	TDM PLUS A2W Hydro unit R410A (Inc. Wired controller)	2,743.00
AE090MXTPGH/EU	9kW	3ph		TDM PLUS A2A & A2W Inverter Heat Pump R410A	1,960.00
AE120MXTPGH/EU	12kW	3ph		TDM PLUS A2A & A2W Inverter Heat Pump R410A	2,739.00
AE160MXTPGH/EU	16kW	3ph		TDM PLUS A2A & A2W Inverter Heat Pump R410A	3,397.00
AE090MNYDGH/EU	4-9kW	3ph	HYDRO	TDM PLUS A2W Hydro unit R410A (Inc. Wired controller)	2,217.00
AE160MNYDGH/EU	12-16kW	3ph	HYDRO	TDM PLUS A2W Hydro unit R410A (Inc. Wired controller)	2,854.00



EHS TDM+ ClimateHub Integrated Hydro Tank *

AE200TNWTEH/EU	TDM+	1ph	200L	TDM+ Integrated Hydro Tank (MWR-WW10N NOT Included) *	3,953.00
AE260TNWTEH/EU	TDM+	1ph	260L	TDM+ Integrated Hydro Tank (MWR-WW10N NOT Included) *	4,029.00

* G3 Kit (purchased from others) required for each ClimateHub installation.

EHS TDM+ Air Conditioning Indoor units

SLIM DUCT	Cool	Heat	Description		LIST PRICE £
AE022ANLDEH/EU	2.2kW	2.5kW		TDM PLUS Slimline Ducted Unit	576.00
AE028ANLDEH/EU	2.8kW	3.2kW		TDM PLUS Slimline Ducted Unit	593.00
AE036ANLDEH/EU	3.6kW	4.0kW		TDM PLUS Slimline Ducted Unit	600.00
AE056ANLDEH/EU	5.6kW	6.3kW		TDM PLUS Slimline Ducted Unit	640.00

MSP DUCT

AE071ANMPEH/EU	7.1kW	8.0kW		TDM PLUS MSP Duct S Unit	712.00
AE090ANMPEH/EU	9.0kW	10.0kW		TDM PLUS MSP Duct S Unit	810.00

FLOOR CONSOLE - Spi filter as standard

AE022MNJDEH/EU	2.2kW	2.5kW		TDM PLUS Floor Console unit	595.00
AE028MNJDEH/EU	2.8kW	3.2kW		TDM PLUS Floor Console unit	618.00
AE036MNJDEH/EU	3.6kW	4.0kW		TDM PLUS Floor Console unit	662.00
AE056MNJDEH/EU	5.6kW	6.3kW		TDM PLUS Floor Console unit	751.00

HIGH WALL - WindFree™ (NO EEV) - please order EEV accessory

AE022TNXDEH/EU	2.2kW	2.5kW		TDM PLUS WindFree high wall unit	484.00
AE028TNXDEH/EU	2.8kW	3.2kW		TDM PLUS WindFree high wall unit	507.00
AE036TNXDEH/EU	3.6kW	4.0kW		TDM PLUS WindFree high wall unit	551.00
AE056TNXDEH/EU	5.6kW	6.3kW		TDM PLUS WindFree high wall unit	595.00
AE071TNXDEH/EU	6.8kW	7.0kW		TDM PLUS WindFree high wall unit	640.00

EHS Accessories TDM+ Air to Air indoor units

Model Reference	Description	LIST PRICE £
MEV-E24SA	EEV Kit (1 Indoor) for Wall unit with no EEV	<4kW 90.00
MEV-E32SA	EEV Kit (1 Indoor) for Wall unit with no EEV	>4kW 99.00
MXD-E24K132A	EEV Kit (2 Indoor) for Wall unit with no EEV	port 1 <4kW, port 2 >4kW 237.00
MXD-E24K200A	EEV Kit (2 Indoor) for Wall unit with no EEV	port 1 <4kW, port 2 <4kW 237.00
MXD-E32K200A	EEV Kit (2 Indoor) for Wall unit with no EEV	port 1 >4kW, port 2 >4kW 237.00
MXD-E24K232A	EEV Kit (3 Indoor) for Wall unit with no EEV	port 1 <4kW, port 2 <4kW, port 3 >4kW 301.00
MXD-E24K300A	EEV Kit (3 Indoor) for Wall unit with no EEV	port 1 <4kW, port 2 <4kW, port 3 <4kW 301.00
MXD-E32K224A	EEV Kit (3 Indoor) for Wall unit with no EEV	port 1 <4kW, port 2 >4kW, port 3 >4kW 301.00
MXD-E32K300A	EEV Kit (3 Indoor) for Wall unit with no EEV	port 1 >4kW, port 2 >4kW, port 3 >4kW 301.00
MWR-WW10N	LCD Colour Premium Wired Remote Control for EHS Heating Control	90.00
MWR-WG00JN	LCD COLOUR PREMIUM Wired Controller (NASA) for Indoor units	90.00
MWR-SH11N	Simplified Wired Remote Controller (NASA) for Indoor units	88.00
AR-EH03E	WindFree & STANDARD Wireless Remote controller for indoor units	34.00
MRK-A10N	DUCT S & Slim Duct Wireless Signal Receiver Kit (requires AR-EH03E)	33.00
MIM-H04EN	Wi-Fi Receiver 2.0 for NASA EHS	132.00
MXJ-YA1509M	Y-Joint (<15kW)	53.00
MDP-E075EE3D	Drain Pump for Slimline Ducted Unit	77.00
MDP-G075SP	Drain Pump for DUCT S Ducted Unit	72.00
MRW-TA	Remote Temperature Sensor	22.00

Services

UK Deliveries

A next day UK mainland delivery service* is available provided the goods are in UK stock and the order is received by our Order Processing Team before 2pm.

Please use the following email address to place orders: order.aircon@samsung.com

A normal weekday delivery service on a tail lift lorry is between 8am and 5:30pm and is Free of Charge.

Additional Delivery Service charges are as follows:

Code	Description	Price £
L-DLVYAM12/E1	Delivery before 12 Noon	30.00
L-DLVYPRE10/E1	Delivery before 10AM	50.00
L-DLVYPM17/E1	Delivery in afternoon (post 12 Noon)	30.00
L-DLVYFIXTM2/E1	Delivery at a fixed time (2hr Window)	60.00
L-DLVYSATDAY/E1	Delivery on Saturday	150.00
L-DLVYDEDICAT/E1	Delivery on Dedicated vehicle	250.00
L-DLVYCRANE/E1	Delivery on HiAB Vehicle	800.00

Please note:

Normal weekday delivery service on a tail lift lorry is between 8am and 5:30pm and is Free of Charge.

Before 12:00 Noon and before 10:00AM deliveries will still be chargeable even if delivered up to 1 hour later than the prescribed time, to allow for unforeseen traffic issues/accidents, site congestion and offloading delays outside of our control which may affect the final delivery time.

Before 10:00AM deliveries arranged the previous day will not always be possible for the following postcodes: TR,PL,SA,LL,SY,FK,G,KY,DD,EH,ML,KA,DG,TD.

Saturday, Dedicated or HiAB vehicle deliveries require orders to be processed at least 3 working days prior to delivery date.

* Northern Scotland will be a 48 to 72 hr delivery service, covering postcodes PA, PH, AB, IV, KW.

HiAB vehicles specification will be provided during the quotation process.

Commissioning

On-site commissioning assistance is available from Samsung approved trained technicians.

Commissioning rates below are determined by the installed equipment type and quantity, please forward a DVM Pro report to tech.aircon@samsung.com for price confirmation.

Availability is subject to demand so please book assisted commissioning in advance

Commissioning Service Charges are as follows:

Code	Description	Per	Price £
AI-INSTDVM00	DVM, Commissioning DVM Half Day	Half Day	300.00
AI-INSTDVM01	DVM, Commissioning DVM Full Day	Full Day	550.00
AI-INSTDVM02	DVM, Commissioning DVM Per Hour	Per Hour	75.00
AI-INSTEHS00	EHS, Commissioning Air to Water (EHS) Half Day	Half Day	300.00
AI-INSTEHS01	EHS, Commissioning Air to Water (EHS) Full Day	Full Day	550.00
AI-INSTEHS02	EHS, Commissioning Air to Water (EHS) Per Hour	Per Hour	75.00
AI-INSTSAC01	Additional Travel cost	Per Mile	0.45

Please note that above prices and confirmed attendance assumes*:

The Installation has been carried out by a Samsung trained Installer.

A Pre-commissioning check list has been completed.

The Installer engineer is in attendance for duration of commissioning and has a MIM-C02N (diagnostic tool - see page 36) connected to a Laptop PC.

Safe access to all equipment is available.

System trim charge has already been added during pre-commissioning.

Reclaim equipment and virgin refrigerant is available on site.

**If any of the above requirements are not adhered to, the site visit may be halted and re-booked at additional cost, or additional costs will apply on the day.*



Learn more about Samsung Climate Solutions at:
www.samsung.com/climate

Samsung Electronics Air Conditioner Europe B.V.
Evert Van Beekstraat 310
1118 CX Schiphol
Netherlands

Terms & Conditions

This price list is subject to our Standard Terms and Conditions of Sale.

This price list will take effect from 1 April 2022 and will remain valid until further notice.

All prices quoted are excluding VAT and will be charged at the prevailing rate. Our standard delivery terms are 1 to 3 days, delivered kerbside to your UK mainland premises, from our acceptance of your order.

All deliveries will be made during normal working hours with unlimited access. AM/PM, Timed deliveries, or any additional delivery requirements will be subject to additional costs.

Samsung cannot accept the return of goods that have been unboxed and/or signs of visible damage to the packaging or the unit within, unless reported to Samsung in writing <72hrs following delivery.

DISCLAIMER

Although we endeavour to ensure the technical and factual accuracy of all the content of this document, associated attachments and additional brochures, this cannot be guaranteed. For further information on liabilities and our terms and conditions, please visit www.samsung.com/climate.

Electrical information provided is guidance and values should be confirmed by a qualified electrician.

SAMSUNG